

Color imageCLASS LBP7780Cdn

Service Manual

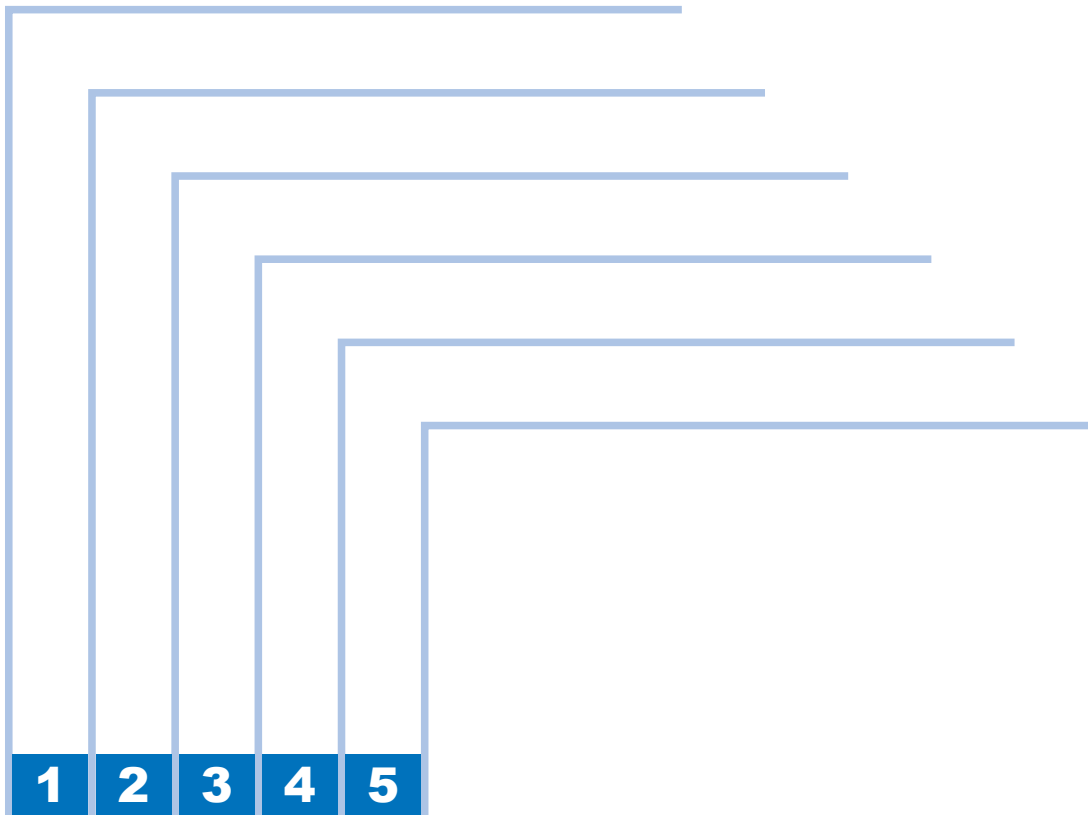

Application

This manual has been issued by Canon Inc. for qualified persons to learn technical theory, installation, maintenance, and repair of products. This manual covers all localities where the products are sold. For this reason, there may be information in this manual that does not apply to your locality.

Corrections

This manual may contain technical inaccuracies or typographical errors due to improvements or changes in products. When changes occur in applicable products or in the contents of this manual, Canon will release technical information as the need arises. In the event of major changes in the contents of this manual over a long or short period, Canon will issue a new edition of this manual.

The following paragraph does not apply to any countries where such provisions are inconsistent with local law.

Trademarks

The product names and company names used in this manual are the registered trademarks of the individual companies.

Copyright

This manual is copyrighted with all rights reserved. Under the copyright laws, this manual may not be copied, reproduced or translated into another language, in whole or in part, without the written consent of Canon Inc.



(C) CANON INC. 2012

Caution

Use of this manual should be strictly supervised to avoid disclosure of confidential information.



Explanation of Symbols

The following symbols are used throughout this Service Manual.

Symbols	Explanation
	Used to show permission.
	Used to show prohibition.

The following rules apply throughout this Service Manual:

1. Each chapter contains sections explaining the purpose of specific functions and the relationship between electrical and mechanical systems with reference to the timing of operation.

In the diagrams,  represents the path of mechanical drive; where a signal name accompanies the symbol, the arrow  indicates the direction of the electric signal.

The expression "turn on the power" means flipping on the power switch, closing the front door, and closing the delivery unit door, which results in supplying the machine with power.

2. In the digital circuits, '1' is used to indicate that the voltage level of a given signal is "High", while '0' is used to indicate "Low". (The voltage value, however, differs from circuit to circuit.) In addition, the asterisk (*) as in "DRMD*" indicates that the DRMD signal goes on when '0'.

In practically all cases, the internal mechanisms of a microprocessor cannot be checked in the field. Therefore, the operations of the microprocessors used in the machines are not discussed: they are explained in terms of from sensors to the input of the DC controller PCB and from the output of the DC controller PCB to the loads.

The descriptions in this Service Manual are subject to change without notice for product improvement or other purposes, and major changes will be communicated in the form of Service Information bulletins.

All service persons are expected to have a good understanding of the contents of this Service Manual and all relevant Service Information bulletins and be able to identify and isolate faults in the machine.

Blank Page

Contents

1 Product Description

Characteristics	1-2
System Configuration	1-2
System Configuration	1-2
Product Specifications	1-4
Host Machine Specifications (LBP7750C/LBP5460)	1-4
Host Machine Specifications (LBP7780C/LBP5480)	1-5
Detailed Specification	1-7
Printing Speed	1-7
LBP7750C/LBP5460	1-7
LBP7780C/LBP5480	1-7
Paper Type	1-8
Paper Size	1-8
Parts Name	1-9
External View	1-9
Front View of the Printer	1-9
Back View of the Printer	1-10
Inside of the Printer	1-11
Cross Section View	1-12
Operation	1-12
Control Panel	1-12
LBP7750C/LBP5460	1-12
Lamp	1-13
Control Panel Key	1-13
LBP7780C/LBP5480	1-14
LAMP	1-15
Control Panel key	1-15
Job Menu	1-17
Setting Items	1-17
Setup Menu	1-17
Control Menu Options (LBP7750C/LBP5460)	1-17
Control Menu (LBP7780C/LBP5480)	1-18

Paper Source Menu Options (LBP7750C/LBP5460)	1-19
Paper Source (LBP7780C/LBP5480)	1-20
Standard Network Menu Options (LBP7750C/LBP5460)	1-20
Network (LBP7780C/LBP5480)	1-22
Layout Menu Options (LBP7750C/LBP5460)	1-23
Layout (LBP7780C/LBP5480)	1-23
Quality Menu Options (LBP7750C/LBP5460)	1-23
Quality (LBP7780C/LBP5480)	1-24
Interface Menu Options (LBP7750C/LBP5460)	1-26
Interface (LBP7780C/LBP5480)	1-26
User Maintenance Options (LBP7750C/LBP5460)	1-26
User Maintenance (LBP7780C/LBP5480)	1-27
Print Mode Options (LBP7750C/LBP5460)	1-27
Print Mode (LBP7780C/LBP5480)	1-27
UFR II (LBP7780C/LBP5480)	1-27
PCL (LBP7780C/LBP5480)	1-28
Imaging (LBP7780C/LBP5480)	1-28
XPS (LBP7780C/LBP5480)	1-28
Imaging (LBP7780C/LBP5480)	1-29
PS(LBP7780C/LBP5480)	1-29
MEAP Setting (LBP7780C/LBP5480)	1-30
Check Counter (LBP7780C/LBP5480)	1-30
Initialize Menu (LBP7780C/LBP5480)	1-30
Utility Menu (LBP7750C/LBP5460)	1-30
Utility Menu (LBP7780C/5480)	1-30
Reset Menu (LBP7750C/LBP5460)	1-31
Reset Menu (LBP7780C/LBP5480)	1-31
Select Feeder Menu (LBP7750C/LBP5460)	1-31
Select Feeder (LBP7780C/5480)	1-31
Application (LBP7780C/LBP5480)	1-32
Safety Precautions	1-33
Laser Safety	1-33
CDRH Regulation	1-33
Toner Safety	1-33
About Toner	1-33
How to Handle Adhered Toner	1-33
Remedy against toner spill	1-33
How to Handle the Laser Scanner Unit	1-33

Points to Note when Replacing/Discarding a Lithium Battery -----	1-34
Points to Note when Performing Disassembly/Assembly-----	1-34

2 Technical Reference

Basic Configuration-----	2-2
Functional Configuration-----	2-2
Operation Sequence-----	2-3
Overview-----	2-3
Laser Exposure System-----	2-4
Overview-----	2-4
Detecting a Failure in the Optical Assembly-----	2-4
Safety-----	2-4
Image Formation System-----	2-5
Overview-----	2-5
Image Formation Process-----	2-5
Overview-----	2-5
Static Latent Image Formation Block-----	2-6
Development Block-----	2-7
Transfer Block-----	2-7
Fixing Block-----	2-8
ITB Cleaning Block-----	2-9
Photosensitive Drum Cleaning Block-----	2-9
Controls-----	2-9
High-voltage Power Supply Control-----	2-9
Calibration-----	2-10
Cartridge-----	2-12
Overview-----	2-12
Memory Tag-----	2-12
Cartridge Presence Detection-----	2-12
Toner Level Detection-----	2-12
Cartridge Life Detection-----	2-12
Developing Assembly Engagement/Disengagement Control-----	2-13
ITB Unit-----	2-14
Overview-----	2-14
Primary Transfer Roller Engagement/Disengagement Control-----	2-15
ITB Cleaning Mechanism-----	2-16
Fixing System-----	2-17

Overview-----	2-17
Various Controls-----	2-17
Speed Control with Small Size Paper (Throughput Down Control)-----	2-17
Fixing Temperature Control-----	2-18
Pressure Roller Pressure Release Control-----	2-19
Protection Function-----	2-20
Failure Detection-----	2-20
Pickup Feeding System-----	2-22
Overview-----	2-22
Pickup Feeding Assembly-----	2-23
Overview-----	2-23
Cassette Pickup-----	2-24
Cassette Presence Detection-----	2-24
Lifting Operation-----	2-25
Cassette Paper Presence Detection-----	2-25
Cassette Double Feeding Prevention Mechanism-----	2-26
Multi-purpose Tray Pickup-----	2-26
Paper Feed-----	2-27
Skew Correction Mechanism-----	2-28
OHT Detection Mechanism-----	2-28
Fixing/Delivery Assembly-----	2-29
Overview-----	2-29
Loop Control-----	2-29
Duplex Assembly-----	2-30
Overview-----	2-30
Duplex Reverse/Duplex Feed Control-----	2-30
Duplex Pickup Operation-----	2-30
Jam Detection-----	2-31
Overview-----	2-31
Pickup Delay Jam-----	2-31
Pickup Stationary Jam-----	2-31
Fixing Delivery Delay Jam-----	2-31
Fixing Delivery Stationary Jam-----	2-31
Wrapping Jam-----	2-31
Residual Paper Jam-----	2-32
Door Open Jam-----	2-32
Controller System-----	2-33
Overview-----	2-33

DC Controller PCB -----	2-33	Other License File Management Functions -----	2-63
Overview -----	2-33	Enhanced System Application Management -----	2-66
Motor/Fan Control -----	2-35	Outline -----	2-66
Failure Detection -----	2-36	About Login Service -----	2-66
Low-voltage Power Supply -----	2-36	Default Authentication overview -----	2-66
Overview -----	2-36	Other Log in service -----	2-66
Protection Function -----	2-37	Procedure Changing Login Services -----	2-66
Safety -----	2-37	Procedure Installing Login Services -----	2-67
Power Supply Voltage Detection Function -----	2-38	Procedure Uninstalling Login Services -----	2-68
Sleep Mode -----	2-38	System Application Management -----	2-68
Low-voltage Power Supply Failure -----	2-38	Procedure to manage System Application -----	2-68
MEAP -----	2-39	System Information -----	2-69
Introduction -----	2-39	Outline -----	2-69
References by purpose -----	2-39	Checking the System Information -----	2-69
About MEAP -----	2-39	Display of System Information Details -----	2-69
Overview -----	2-39	Printing the System Information of a MEAP Application -----	2-70
About SMS -----	2-40	Content of MEAP system information -----	2-70
Overview -----	2-40	MEAP Application Information -----	2-71
About the MEAP Application Management Screen -----	2-40	Outline -----	2-71
About the MEAP Application Installation Screen -----	2-40	Procedure to Check MEAP Application Information -----	2-71
About System Management -----	2-41	Check License -----	2-72
Preparation for Using SMS -----	2-42	Outline -----	2-72
Preparation of PC for Accessing SMS -----	2-42	Procedure to Check the License File -----	2-72
Device Settings -----	2-42	Changing SMS Login Password -----	2-72
How to Check the Serial Number -----	2-48	Outline -----	2-72
Login to SMS -----	2-49	Procedure to Change the SMS Login Password -----	2-72
Procedure to Log in -----	2-49	MEAP Application Setting Information Management and Log Management -----	2-73
Installing an MEAP Application -----	2-52	Outline -----	2-73
Outline -----	2-52	Advantages Obtained When Using the Services -----	2-73
Procedure to install applications -----	2-52	MEAP Application Setting Information Management -----	2-74
Resource Information -----	2-54	MEAP Application Log Management -----	2-74
About MEAP Application Management Page -----	2-54	Maintenance -----	2-75
MEAP Specifications -----	2-55	When Replacing the PCB -----	2-75
What is MEAP Specifications (MEAP Spec Version)? -----	2-55	Actions to be taken when E616 is displayed. -----	2-76
MEAP Application Management -----	2-57	MEAP Safe Mode -----	2-77
Outline -----	2-57	Using USB Devices -----	2-78
Starting, Stopping, or Uninstalling the MEAP Application -----	2-57	Reference material -----	2-79
Managing the License File -----	2-59		

Glossary	2-79
Embedded RDS	2-81
Product Overview	2-81
Overview	2-81
Features and benefits	2-81
Service cautions	2-81
E-RDS Setup	2-82
Confirmation and preparation in advance	2-82
Steps to E-RDS settings	2-83
Initializing E-RDS settings	2-85
FAQ	2-86
Troubleshooting	2-88
Error code and strings	2-90
SSL	2-92
A making procedure	2-92
Setting the SSL Encryption Communication Function	2-97

3 Disassembly and Assembly

Introduction	3-2
Points to Note During Disassembly and Assembly	3-2
Lay Out Drawing	3-3
External-related Issues	3-3
Main Units	3-4
Main Parts	3-7
PCB-related Issues	3-8
External-related Issues	3-11
Removing Left Cover	3-11
Removing Left Cover(LBP7780C/LBP5480)	3-11
Removing Rear Cover	3-12
Before Removing Rear Cover	3-12
Removing the Rear Cover	3-12
Removing Rear Cover(LBP7780C/LBP5480)	3-12
Before Removing Rear Cover	3-12
Removing the Rear Cover	3-12
Removing Right Rear Cover	3-13
Before Removing Right Rear Cover	3-13
Removing the Right Rear Cover	3-13

Removing Right Rear Cover(LBP7780C/LBP5480)	3-13
Removing the Right Rear Cover	3-13
Removing the Control Panel Unit Right Cover	3-14
Remove the Control Panel Unit Right Cover(LBP7780C/LBP5480)	3-14
Removing the Control Panel Unit Left Cover	3-15
Before Removing Control Panel Unit Left Cover	3-15
Removing the Control Panel Unit Left Cover	3-15
Removing the Control Panel Unit Left Cover(LBP7780C/LBP5480)	3-15
Before Removing Control Panel Unit Left Cover	3-15
Removing Upper Front Cover Unit	3-16
Before removing upper front cover unit	3-16
Removing the Upper Front Cover Unit	3-16
Removing Upper Front Cover Unit(LBP7780C/LBP5480)	3-17
Before removing upper front cover unit	3-17
Removing the Upper Front Cover Unit	3-17
Removing Control Panel Unit	3-19
Before Removing Control Panel Unit	3-19
Removing Control Panel Unit	3-19
Removing Control Panel Unit(LBP7780C/LBP5480)	3-20
Before Removing Control Panel Unit	3-20
Removing Control Panel Unit	3-20
Removing Upper Rear Cover	3-21
Before Removing the Upper Rear Cover	3-21
Removing Upper Rear Cover	3-21
Removing Upper Rear Cover(LBP7780C/LBP5480)	3-21
Before Removing the Upper Rear Cover	3-21
Removing Upper Rear Cover	3-21
Removing the Front Cover Unit	3-22
Removing Front Right Cover	3-23
Before Removing Front Right Cover	3-23
Removing Front Right Cover	3-23
Removing Front Right Cover(LBP7780C/LBP5480)	3-24
Before Removing Front Right Cover	3-24
Removing Front Right Cover	3-24
Removing the Right Cover Unit	3-25
Removing the Right Cover Unit(LBP7780C/5480)	3-26
Main Units	3-27

Removing Secondary Transfer Unit-----	3-27
Removing ITB Unit -----	3-27
Removing Fixing Assembly-----	3-28
Removing Waste Toner Container-----	3-29
Remove the Waste Toner Container(LBP7780C/LBP5480) -----	3-29
Removing Waste Toner Full Sensor Unit -----	3-30
Before Removing Waste Toner Full Sensor Unit -----	3-30
Removing the Waste Toner Full Sensor Unit -----	3-30
Removing Waste Toner Full Sensor Unit(LBP7780C/LBP5480)-----	3-31
Before Removing Waste Toner Full Sensor Unit -----	3-31
Removing the Waste Toner Full Sensor Unit -----	3-31
Removing Waste Toner Feed Motor Unit -----	3-32
Before Removing Waste Toner Feed Motor Unit -----	3-32
Removing Waste Toner Feed Motor Unit -----	3-32
Removing Waste Toner Feed Motor Unit(LBP7780C/LBP5480) -----	3-33
Before Removing Waste Toner Feed Motor Unit -----	3-33
Removing Waste Toner Feed Motor Unit -----	3-33
Removing Registration Unit -----	3-34
Before Removing Registration Unit -----	3-34
Removing Registration Unit -----	3-34
Removing Registration Unit(LBP7780C/LBP5480) -----	3-35
Before Removing Registration Unit -----	3-35
Removing Registration Unit -----	3-35
Removing Color Displacement/Density Sensor Unit-----	3-37
Before Removing Color Displacement/Density Sensor Unit-----	3-37
Removing Color Displacement/Density Sensor Unit -----	3-37
Removing Color Displacement/Density Sensor Unit(LBP7780C/5480)--- 3-38	
Before Removing Color Displacement/Density Sensor Unit-----	3-38
Removing Color Displacement/Density Sensor Unit -----	3-38
Removing Lifter Drive Unit-----	3-39
Before Removing Lifter Drive Unit-----	3-39
Removing Lifter Drive Unit -----	3-39
Removing Lifter Drive Unit(LBP7780C/LBP5480)-----	3-40
Before Removing Lifter Drive Unit-----	3-40
Removing Lifter Drive Unit -----	3-40
Removing Laser Scanner Unit-----	3-41

Before Removing Laser Scanner Unit-----	3-41
Removing Y/M Laser Scanner Unit -----	3-41
Removing C/Bk Laser Scanner Unit -----	3-43
Removing Laser Scanner Unit(LBP7780C/LBP5480)-----	3-45
Before Removing Laser Scanner Unit-----	3-45
Removing Y/M Laser Scanner Unit -----	3-45
Removing C/Bk Laser Scanner Unit -----	3-47
Removing Cassette Pickup Drive Unit-----	3-50
Before Removing Cassette Pickup Drive Unit(LBP7750C/LBP5460) -----	3-50
Before Removing Cassette Pickup Drive Unit(LBP7780C/LBP5480) -----	3-50
Removing Cassette Pickup Drive Unit -----	3-50
Removing Cassette Pickup Unit -----	3-52
Before Removing Cassette Pickup Unit -----	3-52
Removing Cassette Pickup Unit -----	3-52
Removing Cassette Pickup Unit(LBP7780C/LBP5480)-----	3-53
Before Removing Cassette Pickup Unit -----	3-53
Removing Cassette Pickup Unit -----	3-53
Removing the Main Drive Unit-----	3-55
Before Removing the Main Drive Unit-----	3-55
Removing the Main Drive Unit-----	3-55
How to Check the Phase of Main Drive Unit Cam -----	3-57
Removing the Main Drive Unit(LBP7780C/LBP5480) -----	3-58
Before Removing the Main Drive Unit-----	3-58
Removing the Main Drive Unit-----	3-58
How to Check the Phase of Main Drive Unit Cam -----	3-60
Removing the Fixing Drive Unit -----	3-61
Before Removing the Fixing Drive Unit -----	3-61
Removing the Fixing Drive Unit -----	3-62
Removing the Fixing Drive Unit(LBP7780C/LBP5480)-----	3-63
Before Removing the Fixing Drive Unit -----	3-63
Removing the Fixing Drive Unit -----	3-63
Removing the Delivery Unit -----	3-64
Before Removing the Delivery Unit -----	3-64
Removing the Delivery Unit -----	3-65
Removing the Delivery Unit(LBP7780C/LBP5480)-----	3-66
Before Removing the Delivery Unit -----	3-66
Removing the Delivery Unit -----	3-67
Removing the Duplex Drive Unit-----	3-68

Before Removing the Duplex Drive Unit	3-68
Removing the Duplex Drive Unit	3-69
Removing the Duplex Drive Unit(LBP7780C/LBP5480)	3-69
Before Removing the Duplex Drive Unit	3-69
Removing the Duplex Drive Unit	3-70
Removing the Duplex Feed Roller Unit	3-70
Removing the Duplex Feed Roller Unit(LBP7780C/LBP5480)	3-71
Removing the Multi-purpose Tray Pickup Unit	3-71
Before Removing the Multi-purpose Tray Pickup Unit	3-71
Removing the Multi-purpose Tray Pickup Unit	3-71
Removing the Multi-purpose Tray Pickup Unit (LBP7780C/LBP5480)	3-74
Before Removing the Multi-purpose Tray Pickup Unit	3-74
Removing the Multi-purpose Tray Pickup Unit	3-74
Removing the Auto Close Unit(LBP7780C/LBP5480)	3-76
Before Removing the Auto Close Unit	3-76
Removing the Auto Close Unit	3-76
Main Parts	3-77
Removing the Cassette Pickup Roller	3-77
Before Removing the Cassette Pickup Roller	3-77
Removing the Cassette Pickup Roller	3-77
Removing the Cassette Pickup Roller(LBP7780C/LBP5480)	3-78
Before Removing the Cassette Pickup Roller	3-78
Removing the Cassette Pickup Roller	3-78
Removing the Cassette Separation Roller Assembly	3-79
Removing the Power Fan	3-79
Before Removing the Power Fan	3-79
Removing the Power Fan	3-79
Removing the Power Fan(LBP7780C/LBP5480)	3-81
Before Removing the Power Fan	3-81
Removing the Power Fan	3-81
Removing the Fan Unit	3-82
Before Removing the Fan Unit	3-82
Removing the Fan Unit	3-82
Removing the Fan Unit(LBP7780C/LBP5480)	3-84
Before Removing the Fan Unit	3-84
Removing the Fan Unit	3-84

Removing the Developing Disengagement Motor	3-85
Before Removing the Developing Disengagement Motor	3-85
Removing the Developing Disengagement Motor	3-85
Removing the Developing Disengagement Motor(LBP7780C/LBP5480)	3-86
Before Removing the Developing Disengagement Motor	3-86
Removing the Developing Disengagement Motor	3-86
Removing the Secondary Transfer Outer Roller Unit	3-86
Removing the Pickup Motor	3-87
Before Removing the Pickup Motor	3-87
Removing the Pickup Motor	3-87
Removing the Pickup Motor(LBP7780C/LBP5480)	3-88
Before Removing the Pickup Motor	3-88
Removing the Pickup Motor	3-88
Removing the Drum Motor 1	3-89
Before Removing the Drum Motor 1	3-89
Removing the Drum Motor 1	3-89
Removing the Drum Motor 1(LBP7780C/LBP5480)	3-89
Before Removing the Drum Motor 1	3-89
Removing the Drum Motor 1	3-89
Removing the Drum Motor 2	3-90
Before Removing the Drum Motor 2	3-90
Removing the Drum Motor 2	3-90
Removing the Drum Motor 2(LBP7780C/LBP5480)	3-90
Before Removing the Drum Motor 2	3-90
Removing the Drum Motor 2	3-90
Removing the Drum Motor 3	3-91
Before Removing the Drum Motor 3	3-91
Removing the Drum Motor 3	3-91
Removing the Drum Motor 3(LBP7780C/LBP5480)	3-91
Before Removing the Drum Motor 3	3-91
Removing the Drum Motor 3	3-91
Removing the Fixing Motor	3-92
Before Removing the Fixing Motor	3-92
Removing the Fixing Motor	3-92
Removing the Fixing Motor(LBP7780C/LBP5480)	3-92
Before Removing the Fixing Motor	3-92
Removing the Fixing Motor	3-92

Removing the Delivery Fan -----	3-93	Before Removing the Low Voltage Power Unit -----	3-109
Before Removing the Delivery Fan-----	3-93	Removing the Low Voltage Power Unit -----	3-109
Removing the Delivery Fan -----	3-93	Removing the Low Voltage Power Unit(LBP7780C/LBP5480)-----	3-111
Removing the Delivery Fan(LBP7780C/LBP5480)-----	3-94	Before Removing the Low Voltage Power Unit -----	3-111
Before Removing the Delivery Fan-----	3-94	Removing the Low Voltage Power Unit -----	3-111
Removing the Delivery Fan -----	3-94	Removing the DC Controller PCB -----	3-113
Removing the Cartridge Fan -----	3-95	Before Removing the DC Controller PCB -----	3-113
Before Removing the Cartridge Fan -----	3-95	Removing the DC Controller PCB -----	3-113
Removing the Cartridge Fan -----	3-95	Removing the DC controller PCB(LBP7780C/LBP5480) -----	3-114
Removing the Cartridge Fan(LBP7780C/LBP5480) -----	3-96	Before Removing the DC Controller PCB -----	3-114
Removing the Cartridge Fan -----	3-96	Removing the DC Controller PCB -----	3-114
Removing the Multi-purpose Tray Pickup Roller -----	3-97	Removing the Lower High Voltage Power Supply PCB -----	3-115
Removing the Multi-purpose Tray Separation Pad -----	3-98	Before Removing the Lower High Voltage Power Supply PCB -----	3-115
Removing the Controller Fan -----	3-99	Removing the Lower High Voltage Power Supply PCB -----	3-115
Before Removing the Controller Fan -----	3-99	Removing the Lower High Voltage Power Supply PCB(LBP7780C/ LBP5480) -----	3-117
Removing the Controller Fan -----	3-99	Before Removing the Lower High Voltage Power Supply PCB -----	3-117
PCB-related Issues -----	3-101	Removing the Lower High Voltage Power Supply PCB -----	3-117
Removing the ICB PCB -----	3-101	Removing the Upper High Voltage Power Supply PCB -----	3-119
Before Removing the ICB PCB -----	3-101	Before Removing the Upper High Voltage Power Supply PCB -----	3-119
Removing the ICB PCB -----	3-101	Removing the Upper High Voltage Power Supply PCB -----	3-119
Removing the Main Controller PCB -----	3-101	Removing the Upper High Voltage Power Supply PCB(LBP7780C/ LBP5480) -----	3-121
Before Removing the Main Controller PCB -----	3-104	Before Removing the Upper High Voltage Power Supply PCB -----	3-121
Removing the Main Controller PCB -----	3-104	Removing the Upper High Voltage Power Supply PCB -----	3-121
Before Removing the Main Controller PCB(LBP7780C/LBP5480) -----	3-106	Removing the Environment Sensor -----	3-122
Removing the Main Controller PCB(LBP7780C/LBP5480) -----	3-106	Before Removing the Environment Sensor -----	3-122
Removing the RELAY PCB(LBP7780C/LBP5480) -----	3-107	Removing the Environment Sensor -----	3-122
Before Removing the RELAY PCB -----	3-107	Removing the Environment Sensor(LBP7780C/LBP5480) -----	3-123
Removing the RELAY PCB -----	3-107	Before Removing the Environment Sensor -----	3-123
Removing the ALL NIGHT PCB(LBP7780C/LBP5480) -----	3-107	Removing the Environment Sensor -----	3-123
Before Removing the ALL NIGHT PCB -----	3-107		
Removing the ALL NIGHT PCB -----	3-107		
Removing the SLEEP IF PCB(LBP7780C/LBP5480) -----	3-108		
Before Removing the SLEEP IF PCB -----	3-108		
Removing the SLEEP IF PCB -----	3-108		
Removing the SD CARD PCB(LBP7780C/LBP5480) -----	3-108		
Before Removing the SD CARD PCB -----	3-108		
Removing the Low Voltage Power Unit -----	3-109		

4 Maintenance and Inspection

Periodically Replaced Parts -----	4-2
Periodically Replaced Parts -----	4-2
Consumable Parts -----	4-2
Consumable Parts Replaced by Users -----	4-2

Consumable Parts Replaced by Service Engineers -----	4-2
Periodical Service -----	4-2
Periodical Service -----	4-2
Cleaning -----	4-3
Cleaning Item -----	4-3

5 Troubleshooting

Corrective Actions -----	5-2
Image Failure -----	5-2
Low Density (1) -----	5-2
Low Density (2) -----	5-2
High Density -----	5-3
Blank Image -----	5-3
Coal-black/Solid Color Image -----	5-3
Polka-dot Pattern -----	5-3
Dirt on the Backside -----	5-4
Vertical Line -----	5-4
White Vertical Line (1) -----	5-4
White Vertical Line (2) -----	5-4
Horizontal Line -----	5-5
White Horizontal Line -----	5-5
Dropout of a Specific Color -----	5-5
White Patch -----	5-6
Fixing Failure -----	5-6
Color Displacement -----	5-6
Image Trouble -----	5-7
Skew/Displacement of an Image -----	5-7
Wrinkle/Bend at the Leading Edge -----	5-7
Skewed Image -----	5-7
Dirt -----	5-8
Interval of Dirt or White Patches on the Image -----	5-8
Standard/Adjustment -----	5-9
Test Print -----	5-9
Engine Test Print -----	5-9
Adjustment of the Image Formation System -----	5-10
When Replacing the ITB Unit -----	5-10
Adjustment of the Fixing Assembly -----	5-10
When Replacing the Fixing Assembly -----	5-10

Checking the Pressure Volume (Nip Volume) of the Pressure Roller -----	5-10
Adjustment of Electrical Parts -----	5-11
When Replacing the DC Controller PCB -----	5-11
Replacing the Main Controller PCB -----	5-11
Outline of Electrical Components -----	5-15
Sensor -----	5-15
Motor -----	5-16
Clutch/Solenoid -----	5-16
Fan -----	5-17
LED/Heater/Thermistor/Switch -----	5-17
PCB -----	5-18
Connector Layout Drawing -----	5-21
Connector List(LBP7750C/LBP5460) -----	5-21
Connector List(LBP7780C/LBP5480) -----	5-23
Service Tools -----	5-27
Standard Tools -----	5-27
Special Tools -----	5-27
List of Solvents/Greases -----	5-27
Error Code -----	5-28
Error Code Details -----	5-28
Jam Code -----	5-33
Alarm Code -----	5-34
Version Up -----	5-35
Overview -----	5-35
Overview of Upgrading -----	5-35
Preparation -----	5-35
Necessary System Environment -----	5-35
Before Downloading the System Software -----	5-36
Downloading the System Software -----	5-36
Downloading the System -----	5-36
Service Mode -----	5-39
Service Mode List(LBP7750C/LBP5460) -----	5-39
COUNTER GR. -----	5-39
ADJUST GR. -----	5-39
OPTION GR. -----	5-39
FUNCTION GR. -----	5-40
LOG GR. -----	5-40

F/W UPDATE GR.	5-40
NETWORK GR.	5-41
SP.ADMIN.MODE	5-42
Service Mode List(LBP7780C/LBP5480)	5-42
COUNTER GR.	5-42
ADJUST GR.	5-42
OPTION GR.	5-43
FUNCTION GR.	5-43
LOG GR.	5-44
F/W UPDATE GR.	5-44
NETWORK GR.	5-45
SP.ADMIN.MODE	5-46
Debug log	5-47
Sublog	5-47
Function Overview	5-47
How the log is written	5-47
Collecting Sublog	5-48
Flow of collecting Sublog	5-48
Installing the Sublog Board	5-48
Generating the log	5-49
Collecting log	5-49
Backup/Restoration by Expansion ROM for servicing and Sublog Board	5-50
Function Overview	5-50
What to Prepare	5-50
Prerequisites	5-50
Target Data for Backup	5-50
Backup and Restoration (Export and Import)	5-51
Flow of Export and Import	5-51
Installing the Expansion ROM for servicing and Sublog Board	5-51
Restoration Procedure (Import)	5-52
Others	5-53
Deletion (Erase)	5-53
List of Error Messages	5-54
Updater	5-55
Overview	5-55
Limitations and Cautions	5-58
Preparation	5-59

System Management Operations	5-65
Maintenance	5-68
FAQ	5-69
Error Messages	5-72
Error Codes	5-78

Appendix

General Timing Chart	6-2
General Circuit Diagram	6-3
General Circuit Diagram (1/2)	6-3
General Circuit Diagram (2/2)	6-4
General Circuit Diagram (1/2) (LBP7780C/5480)	6-5
General Circuit Diagram (2/2) (LBP7780C/5480)	6-6
Signal Input/Output List	6-7
Backup Data	6-14



Product Description

- Characteristics
- System Configuration
- Product Specifications
- Detailed Specification
- Parts Name
- Operation
- Safety Precautions

Characteristics

High-Speed Color Printer

This machine is a high-speed color printer, realizing a speed of approximately 30 pages per minute in full-color printing with A4 vertical paper.

Introducing Intermediate Transfer Method (ITB)

This machine introduced an intermediate transfer method, in which 4-color toner images are transferred into an intermediate transfer belt (ITB) and then simultaneously transferred into a printing sheet. This method enabled to realize stable color printing in various types of paper without receiving impact of paper at the time of primary transfer.

Automatic Duplex Printing

This machine supports automatic duplex printing as standard function.

Installation of MEAP

MEAP (Multifunctional Embedded Application Platform) is installed in LBB7780C/LBP5480, and output management by user is enabled by installing MEAP applications.

System Configuration

System Configuration

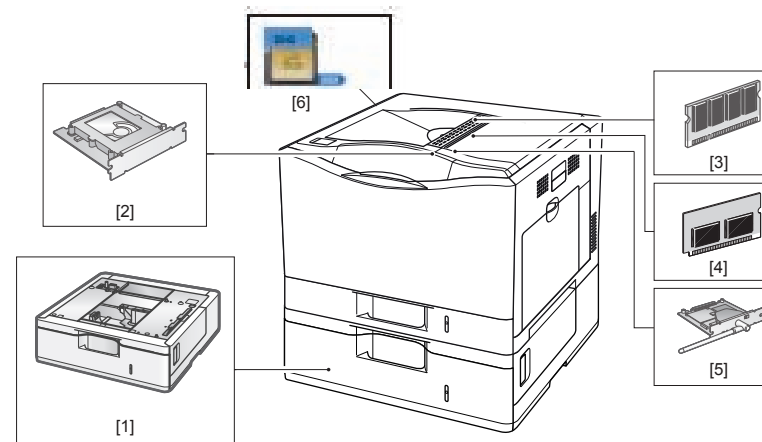

F-1-1

	Option	Description	Model
[1]	Paper Feeder PF-723	1 extra cassette can be installed.	LBP7750C LBP5460
	Paper Feeder PF-723 A	1 extra cassette can be installed.	LBP7780C LBP5480
[2]	Hard Disk Kit HD-723	Hard disk with 60GB	LBP7750C LBP5460
[3]	Extended RAM ER-128A/256A/512A	3 types are provided; 128MB, 256MB, and 512MB	LBP7750C LBP5460
[4]	PS-ROM ROM-A723	PostScript3 emulation mode is contained.	LBP7750C LBP5460
	PS/Barcode ROM ROM-A723A	Following barcode fonts are available. • OCR-B • Symb.FontInform • Symbde stethos • BarDIMM ©1997 • USPS ZEBRA +4Stat	LBP7750C LBP5460
[5]	Built-in Wireless Print Server NB-W2	This enables wireless LAN communication and security supported.	LBP7780C LBP5480 LBP7750C LBP5460

	Option	Description	Model
[6]	SD CARD-B1	1 Received printing jobs can be temporarily stored. 2 . Functions such as spool of printing jobs, encrypted secure print, secured print, electronic sorting, printing in interrupt mode, etc.	LBP7780C LBP5480

Product Specifications

Host Machine Specifications (LBP7750C/LBP5460)

Item	Function / Method
Installation of the host machine	Desktop page printer
Photoreceptor	OPC drum
Charging method	Roller charging
Exposure method	Laser exposure
Developing method	Contact development
Transfer method	Intermediate transfer (ITB)
Transfer (primary transfer) method	Transfer belt
Transfer (secondary transfer) method	Transfer roller
Separation method	Curvature separation
Feeding method	Cassette / manual feeding
Cassette feeding method	Simple retard method
Manual tray feeding method	Pad separation method
Drum cleaning method	Blade
Transfer cleaning method	Blade
Fixing method	On-demand fixing
Delivery method	Face-down
Contrast adjustment function	Automatic
Toner level detection	Enabled (Optical detection)
Toner type	Nonmagnetic 1-component toner
Toner supply method	Replacement of the cartridge
Warm-up time	Less than approx. 60 sec. when the power is turned on (Room temperature: 20 degree C)
Print quality guaranteed range	Excluding 5.0mm from leading edge, trailing edge and right and left edge (10mm for envelope)
Image gradation	16 levels
Print resolution	600dpi x 600dpi
First print time	Black and white printing: 10.2 seconds or less Color printing: 10.4 seconds or less

Item	Function / Method
Paper size for the cassette	Standard sizes: A4, B5, A5, Letter, Executive, 16K Custom paper sizes: <ul style="list-style-type: none"> Portrait orientation (when the short edges of the paper are parallel to the front side of the printer): Short edges 8.27 to 8.50 in.(210.0 to 215.9 mm); Long edges 8.27 to 8.50 in.(210.0 to 215.9 mm) Landscape orientation (when the long edges of the paper are parallel to the front side of the printer): Short edges 5.85 to 8.50 in.(148.0 to 215.9 mm); Long edges 8.27 to 11.69 in. (210.0 to 297.0 mm)
Paper size for the multi-purpose tray	Standard sizes: A4, B5, A5, Legal, Letter, Executive, Statement, Foolscap, 16K, Envelope DL, Envelope No.10, Envelope ISO-C5, Envelope ISO-B5, Envelope Monarch Custom paper sizes: <ul style="list-style-type: none"> Portrait orientation (when the short edges of the paper are parallel to the front side of the printer): Short edges 8.27 to 8.50 in.(210.0 to 215.9 mm); Long edges 8.27 to 8.50 in. (210.0 to 215.9 mm) Landscape orientation (when the long edges of the paper are parallel to the front side of the printer): Short edges 3.87 to 8.50 in.(98.4 to 215.9 mm); Long edges 5.83 to 14.00 in. (148.0 to 355.6 mm)
Paper type for the cassette	Plain paper ^{*1} (60 - 105g/m ²), Thick paper (106 - 163g/m ²), Colored paper, Coated paper ^{*1} : Recycled paper can be used as plain paper.
Paper type for the multi-purpose tray	Plain paper ^{*2} (60 - 105g/m ²), Thick paper (106 - 163g/m ²), Label, Coated paper (100 - 220g/m ²), Postcard, Envelope, OHP film (only for monochrome printing) Paper weight: 60 - 216g/m ² (Excl. coated paper) : 105 - 220g/m ² (Coated paper) ^{*2} : Recycled paper can be used as plain paper.
Paper type for duplex printing	Plain paper ^{*3} (60 - 105g/m ²), Thick paper (106 - 163g/m ²), Colored paper, Coated paper (120 - 220g/m ²) ^{*3} : Recycled paper can be used as plain paper.
Capacity of the cassette	Cassette 1: Approx.250 sheets (80g/m ² paper) Cassette 2 (Option): Approx.500 sheets (80g/m ² paper)
Capacity of the multi-purpose tray	Cassette 1: Approx.100 sheets (80g/m ² paper)
Duplex method	Through-pass method
Stack capacity of the delivery tray	Approx.200 sheets (Plan paper, 80g/m ²)
Memory capacity	256MB (Max. 768MB)
HD capacity	60GB (When an option is installed)

Item	Function / Method
Automatic gradation correction	Enabled
Temperature range in the use environment	10 - 30 degree C
Humidity range in the use environment	10 - 80%RH
Operation noise	Lwad (declared A-weighted sound power level (1B=10dB)) <ul style="list-style-type: none"> • During standby: 5B or less • During operation: 7B or less
	Sound pressure level (bysatander position) <ul style="list-style-type: none"> • During standby: 50dB or less • During operation: 53dB(A) or less
Rated power voltage	100V ± 10%, 110-127V ± 10%, 220-240V ± 10% (50/60Hz ± 2Hz)
Maximum power consumption	Less than 1305W
Power consumption	At standby: Approx. 47W
	Average during operation: Approx. 573W
	Average during deep sleep mode: Approx. 1.8W
Dimension	517 (W) x 530 (D) x 374 (H) mm
Weight	Approx. 31.0kg (Excl. cartridge)

T-1-1

Host Machine Specifications (LBP7780C/LBP5480)

Item	Function / Method
Installation of the host machine	Desktop page printer
Photoreceptor	OPC drum
Charging method	Roller charging
Exposure method	Laser exposure
Developing method	Contact development
Transfer method	Intermediate transfer (ITB)
Transfer (primary transfer) method	Transfer belt
Transfer (secondary transfer) method	Transfer roller
Separation method	Curvature separation
Feeding method	Cassette / manual feeding
Cassette feeding method	Simple retard method
Manual tray feeding method	Pad separation method
Drum cleaning method	Blade
Transfer cleaning method	Blade
Fixing method	On-demand fixing
Delivery method	Face-down
Contrast adjustment function	Automatic
Toner level detection	Enabled (Optical detection)
Toner type	Nonmagnetic 1-component toner
Toner supply method	Replacement of the cartridge
Warm up time (Time from power on to printer ready)	39 seconds or less May vary depending on the usage conditions, such as the availability of the optional accessories and installation environment.
Print quality guaranteed range	Excluding 5.0mm from leading edge, trailing edge and right and left edge (10mm for envelope)
Image gradation	16 levels
Print resolution	600dpi x 600dpi
First print time (When performing 1- sided printing on Letter size paper and outputting facedown)	Black and white printing: 10.2 seconds or less Color printing: 10.4 seconds or less May vary depending on the output environment.

Item	Function / Method
Paper size for the cassette	<p>Standard sizes: A4, B5, A5, A6, Letter, Executive Statement and 16K Custom paper sizes *1:</p> <p>In case of portrait orientation (only when the UFR II printer driver is used): Short edges 5.83 to 8.50 in. (148.0 to 215.9 mm)*2; Long edges 5.83 to 8.50 in. (148.0 to 215.9 mm) In case of landscape orientation: Short edges 4.00 to 8.50 in. (101.6 to 215.9 mm); Long edges 5.83 to 11.69 in. (148.0 to 297.0 mm)*3</p> <p>*1 Width must not be greater than length (height). *2 When width is 8.50 in. (215.9 mm), max length is 11.00 in. (279.4 mm). *3 When length is 11.69 in. (297.0 mm), max width is 8.27 in. (210.0 mm).</p>
Paper size for the multi-purpose tray	<p>Standard sizes: A4, B5, A5, A6, Legal, Letter, Executive, Statement, Foolscap, 16K, Index Card, Envelope DL, Envelope No.10, Envelope ISO-C5, and Envelope Monarch Custom paper sizes *1:</p> <p>In case of portrait orientation (only when the UFR II printer driver is used): Short edges 5.00 to 8.50 in. (127.0 to 215.9 mm); Long edges 5.00 to 8.50 in. (127.0 to 215.9 mm) In case of landscape orientation: Short edges 3.00 to 8.50 in. (76.2 to 215.9 mm); Long edges 5.00 to 14.00 in. (127.0 to 355.6 mm)</p> <p>*1 Width must not be greater than length (height).</p>
Paper type for the cassette	<p>Plain paper^{*1} (60 - 105g/m²), Thick paper (106 - 163g/m²), Colored paper, Coated paper ^{*1}: Recycled paper can be used as plain paper.</p>
Paper type for the multi-purpose tray	<p>Plain paper^{*2} (60 - 105g/m²), Thick paper (106 - 163g/m²), Label, Coated paper (100 - 220g/m²), Postcard, Envelope, OHP film (only for monochrome printing) Paper weight: 60 - 216g/m² (Excl. coated paper) : 105 - 220g/m² (Coated paper) ^{*2}: Recycled paper can be used as plain paper.</p>
Paper type for duplex printing	<p>Plain paper^{*3} (60 - 105g/m²), Thick paper (106 - 163g/m²), Colored paper, Coated paper (120 - 220g/m²) ^{*3}: Recycled paper can be used as plain paper.</p>
Capacity of the cassette	<p>Cassette 1: Approx.500 sheets (80g/m² paper) Cassette 2 (Option): Approx.500 sheets (80g/m² paper)</p>
Capacity of the multi-purpose tray	Cassette 1: Approx.100 sheets (80g/m ² paper)
Duplex method	Through-pass method

Item	Function / Method
Stack capacity of the delivery tray	Approx.200 sheets (Plan paper, 80g/m ²)
Memory capacity	768MB
Automatic gradation correction	Enabled
Temperature range in the use environment	10 - 30 degree C
Humidity range in the use environment	10 - 80%RH
Noise (measured in accordance with ISO 7779, declared noise emission in accordance with ISO 9296)	<ul style="list-style-type: none"> • LwAd (declared A-weighted sound power level (1 B = 10 dB)) • During standby: 5.3 B or less * • During operation: 7.0 B or less • LpAm (declared A-weighted sound pressure level (bystander position)) • During standby: 32.4 dB * • During operation: 52 dB • * Indicates the sound pressure level of each bystander position is below the ISO 7779 absolute criteria for the background noise level.
Rated power voltage	110-127V ± 10%, 220-240V ± 10% (50/60Hz ± 2Hz)
Maximum power consumption	1,305W or less (120V)(with option) 1,185W or less (230V)(with option)
Power consumption (at 68°F (20°C))	<p>Average during operation: Approx. 573 W(120V) Approx. 569 W(230V) Average during standby: Approx. 47 W(120V)(without option) Approx. 44 W(230V)(without option) Average during engine Sleep: Approx. 20W(120V) Approx. 20W(230V) Average during Deep Sleep: Approx. 1W(120V) Approx. 1W(230V)</p>
Dimension	517 (W) x 527.5 (D) x 400.7 (H) mm
Weight	Approx. 31.0 kg (Excl. cartridge)

T-1-2

Detailed Specification

Printing Speed

Printing speed of the LBP7750C/5460 machine is shown below. The machine provides the same speed in both color and monochrome modes.

LBP7750C/LBP5460

Specification of printing speed Unit: 1-sided = sheets / min, 2-sided = pages / min ^{*1}

		Cassette 1 pickup		Multi-purpose tray		Cassette 2 pickup (option)	
		1-sided	2-sided	1-sided	2-sided	1-sided	2-sided
Plain paper (60 to 105 g/m ²)	A4 vertical	30.0	27.6	26.9	7.5	30.0	13.8
	A5 vertical	31.0	-	28.1	-	31.0	-
	B5 vertical	31.0	28.9	28.1	7.7	31.0	14.4
	LGL	-	-	23.4	6.9	25.8	7.0
	LTR vertical	31.0	28.9	28.1	7.7	31.0	14.4
	EXE vertical	31.0	28.9	28.1	7.7	31.0	14.4
Heavy paper (106 to 120 g/m ²)	A4 vertical	15.0	13.7	15.0	3.7	15.0	6.8
	A5 vertical	15.8	-	15.7	-	15.8	-
	B5 vertical	15.8	14.4	15.7	3.8	15.8	7.2
Rough paper (75 to 90 g/m ²)	LGL	-	-	12.8	3.4	12.8	3.5
	LTR vertical	15.8	14.4	15.7	3.8	15.8	7.2
	EXE vertical	15.8	14.4	15.7	3.8	15.8	7.2
Heavy paper (121 to 216 g/m ²)	A4 vertical	-	-	9.5	2.5	-	-
	A5 vertical	-	-	10.0	-	-	-
	B5 vertical	-	-	10.0	2.5	-	-
	LGL	-	-	8.2	2.3	-	-
	LTR vertical	-	-	10.0	2.5	-	-
EXE vertical	-	-	10.0	2.5	-	-	
Label paper		-	-	15.0	-	-	-
Transparency film		-	-	4.0	-	-	-
Envelope		-	-	15.7	-	-	-
Postcard		-	-	10.0	-	10.0	-

T-1-3

LBP7780C/LBP5480

- Specification of printing speed
- Unit: 1-sided = sheets / min, 2-sided = pages / min ^{*1}

		Cassette 1 pickup	Multi-purpose tray
		1-sided	1-sided
Plain paper (60 to 105 g/m ²)	A4 vertical	32.0	27.0
	LTR vertical	33.7	28.2
	B5 vertical	31.7	28.2
	LGL	27.2	23.5
	EXE vertical	31.7	28.2
	A5 vertical	31.7	28.2
Heavy paper (106 to 120 g/m ²) Rough paper (75 to 90 g/m ²)	A4 vertical	15.1	15.1
	LTR vertical	15.8	15.8
	B5 vertical	15.8	15.8
	LGL	12.9	12.9
	EXE vertical	15.8	15.8
Heavy paper (121 to 216 g/m ²)	A5 vertical	15.8	15.8
	A4 vertical	-	9.6
	LTR vertical	-	10.1
	B5 vertical	-	10.1
	LGL	-	8.3
EXE vertical	-	10.1	
A5 vertical	-	10.1	

		Cassette 1 pickup	Multi-purpose tray
		2-sided	2-sided
Plain paper (60 to 105 g/m ²)	A4 vertical	27.6	15.0
	LTR vertical	28.9	15.4
Heavy paper (106 to 120 g/m ²) Rough paper (75 to 90 g/m ²)	A4 vertical	13.7	7.5
	LTR vertical	14.4	7.5

*1: 2 pages = 1 sheet (2 sided front and back page)

Paper Type

- : Both single-sided and duplex printing is supported.
- : Only single-sided printing is supported.
- : Printing cannot be performed.

Paper Type		Setup Menu [Cassette N (N = 1, 2) Type]	Paper Source		
			Multi-purpose tray	Cassette 1	Cassette 2 (Optional)
Plain paper ^{*1}	16.0 to 19.8 lb Bond (60 to 74 g/m ²)	[Plain Paper L] ^{*2}	●	●	●
	18.6 to 27.9 lb Bond (70 to 105 g/m ²)	[Plain Paper] (Default) ^{*2*3} [Rough Paper] ^{*6}	●	●	●
Heavy Paper	26.6 lb Bond to 44.4 lb Cover (100 to 120 g/m ²)	[Heavy Paper 1] ^{*3*4}	●	●	●
	30.6 lb Bond to 60.3 lb Cover (115 to 163 g/m ²)	[Heavy Paper 2] ^{*4}	○	○	○
	60.4 to 65.1 lb Cover (164 to 176 g/m ²)	[Heavy Paper 2]	○	-	○
Transparency (black-and-white printing only)		[Transparencies]	○	-	-
Label		[Label]	○	-	-
Envelope		[Envelope]	○	-	-

T-1-4

*1 Recycled paper can be used as plain paper.

*2 If you want to print paper of 18.6 to 19.8 lb Bond (70 to 74 g/m²), you can specify either of [Plain Paper] or [Plain Paper L].^{*5}

*3 If you want to print paper of 26.6 to 27.9 lb Bond (100 to 105 g/m²), you can specify either of [Plain Paper] or [Heavy Paper1].^{*5}

*4 If you want to print paper of 30.6 lb Bond to 44.4 lb Cover (115 to 120 g/m²), you can specify either of [Heavy Paper 1] or [Heavy Paper 2].^{*5}

*5 If either setting causes the following problems etc., specify the other setting to print.

- Output paper curls.
- Residual images appear on non-printed areas.
- The toner does not fix onto paper well, and the printing comes out faint.

*6 Specify [Rough Paper] for this item when a paper jam occurs or when you want to improve the fixation on printing coarse paper (19.9 to 23.9 lb Bond(75 to 90 g/m²)) with [Plain Paper] selected.

Paper Size

This printer supports the following paper sizes.

- : Both single-sided and duplex printing is supported.
- : Only single-sided printing is supported.
- : Printing cannot be performed.

Paper Size (short edge x long edge)		Paper Source		
		Multi-purpose tray	Cassette 1	Cassette 2 (Optional)
A4 (8.27 in. x 11.69 in. (210.0 mm x 297.0 mm))		●	●	●
B5 (7.17 in. x 10.12 in. (182.0 mm x 257.0 mm))		●	●	●
A5 (5.83 in. x 8.27 in. (148.0 mm x 210.0 mm))		○	○	○
Legal (8.50 in. x 14.00 in. (215.9 mm x 355.6 mm))		●	-	●
Letter (8.50 in. x 11.00 in. (215.9 mm x 279.4 mm))		●	●	●
Executive (7.25 in. x 10.50 in. (184.2 mm x 266.7 mm))		●	●	●
Statement (5.50 in. x 8.50 in. (139.7 mm x 215.9 mm))		○	-	-
Foolscap (8.50 in. x 13.00 in. (215.9 mm x 330.2 mm))		●	-	●
16K (7.68 in. x 10.63 in. (195.0 mm x 270.0 mm))		●	●	●
Custom paper size Portrait ^{*1*3}		○ ^{*5}	○ ^{*6}	○ ^{*6}
Custom paper size Landscape ^{*2*4}		● ^{*7}	● ^{*8}	● ^{*9}
Envelope	Envelope Monarch (3.87 in. x 7.50 in. (98.4 mm x 190.5 mm))	○	-	-
	Envelope No.10 (4.12 in. x 9.50 in. (104.7 mm x 241.3 mm))	○	-	-
	Envelope DL (4.33 in. x 8.66 in. (110.0 mm x 220.0 mm))	○	-	-
	Envelope ISO-C5 (6.38 in. x 9.02 in. (162.0 mm x 229.0 mm))	○	-	-
	Envelope ISO-B5 (6.93 in. x 9.84 in. (176.0 mm x 250.0 mm))	○	-	-

T-1-5

*1 Portrait: The short edges of the paper are parallel to the front side of the printer.

*2 Landscape: The long edges of the paper are parallel to the front side of the printer.

*3 Can be loaded only when the UFR II printer driver is used.

*4 Automatic 2-sided printing can be performed on the custom size paper whose short edges are 7.17 to 8.50 in. (182.0 to 215.9 mm) and long edges are 10.12 to 11.69 in. (257.0 to 297.0 mm).

- *5 The custom size paper whose short edges are 5.83 to 8.50 in. (148.0 to 215.9 mm) and long edges are 5.83 to 8.50 in. (148.0 to 215.9 mm) can be loaded.
- *6 The custom size paper whose short edges are 8.27 to 8.50 in. (210.0 to 215.9 mm) and long edges are 8.27 to 8.50 in. (210.0 to 215.9 mm) can be loaded.
- *7 The custom size paper whose short edges are 3.87 to 8.50 in. (98.4 to 215.9 mm) and long edges are 5.83 to 14.00 in. (148.0 to 355.6 mm) can be loaded.
- *8 The custom size paper whose short edges are 5.83 to 8.50 in. (148.0 to 215.9 mm) and long edges are 8.27 to 11.69 in. (210.0 to 297.0 mm) can be loaded.
- *9 The custom size paper whose short edges are 5.83 to 8.50 in. (148.5 to 215.9 mm) and long edges are 8.27 to 14.00 in. (210.0 to 355.6 mm) can be loaded.

Parts Name

Caution :

Be sure not to cover the vent with a wall or an article. If it is covered, the inside of the printer becomes hot, which may cause a fire.

External View

Front View of the Printer

LBP7750C/LBP5460

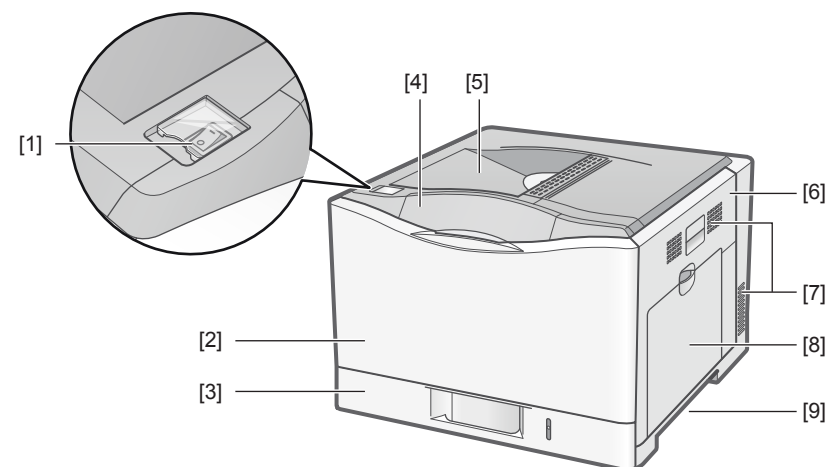

- | | | | |
|-----|---------------|-----|--------------------|
| [1] | Power switch | [6] | Right cover |
| [2] | Front cover | [7] | Vent |
| [3] | Cassette | [8] | Multi-purpose tray |
| [4] | Control Panel | [9] | Grip |
| [5] | Delivery tray | | |

F-1-2

● LBP7780C/LBP5480

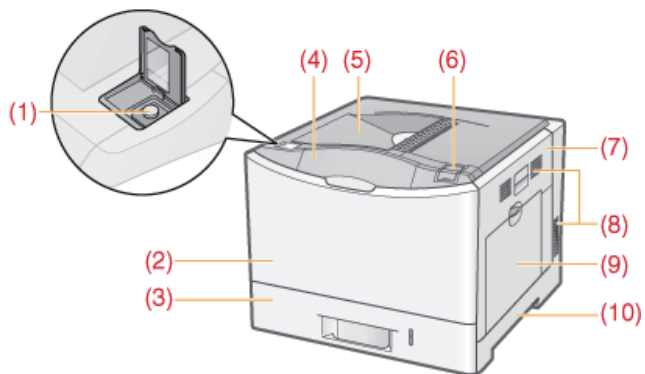

[1]	Power switch	[6]	USB memory connector
[2]	Front cover	[7]	Right cover
[3]	Cassette	[8]	Ventilation Slots
[4]	Control Panel	[9]	Multi-purpose tray
[5]	Delivery tray	[10]	Lift Handles

F-1-3

■ Back View of the Printer

● LBP7750C/LBP5460

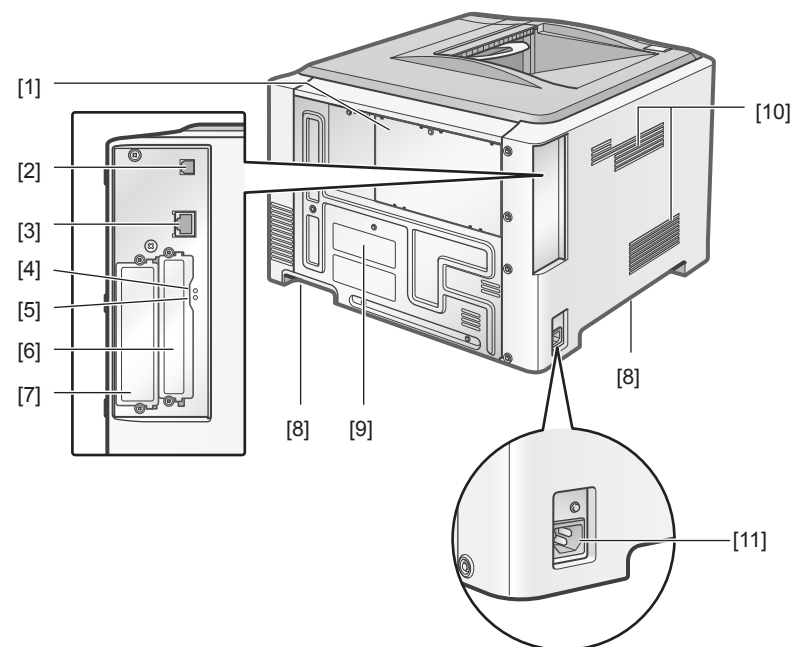

[1]	Slot cover	[8]	Grip
[2]	USB connector	[9]	Rated voltage label
[3]	LAN connector	[10]	Vent
[4]	LNK/ACT lamp (green)	[11]	Power cord slot
[5]	10/100 lamp (green)		
[6]	Hard disk slot		
[7]	Extended board slot		

F-1-4

● LBP7780C/LBP5480

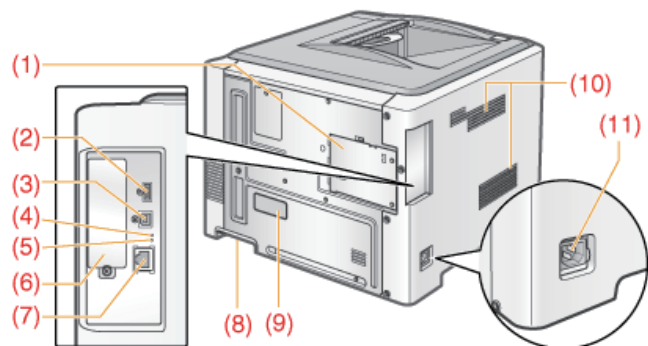

F-1-5

[1]	Slot Cover	[7]	LAN Connector
[2]	USB Connector (for USB devices)	[8]	Lift Handles
[3]	USB Connector (for connecting to computer)	[9]	Rating Label
[4]	ACT Indicator (Green)	[10]	Ventilation Slots
[5]	LNK Indicator (Green)	[11]	Power Socket
[6]	SD Card Slot Cover		

■ Inside of the Printer

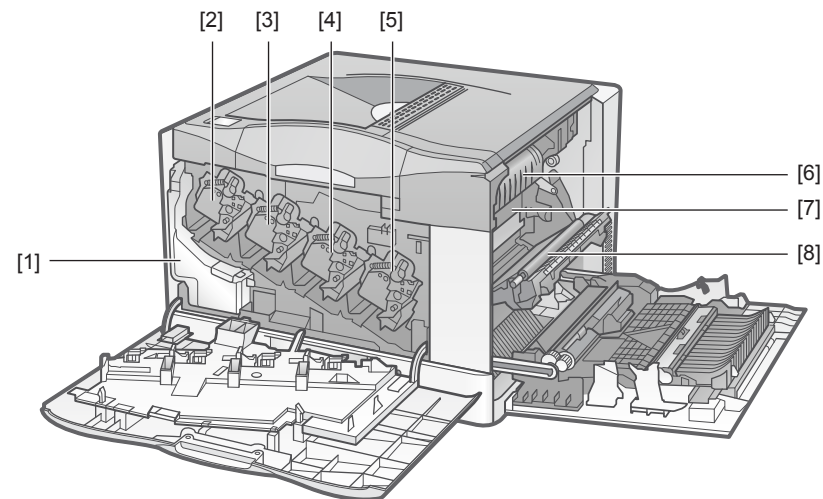

F-1-6

- [1] Waste toner container
- [2] Y (Yellow) toner cartridge
- [3] M (Magenta) toner cartridge
- [4] C (Cyan) toner cartridge
- [5] K (Black) toner cartridge
- [6] Fixing assembly
- [7] ITB (Intermediate Transfer Belt) unit
- [8] Secondary transfer external roller

Cross Section View

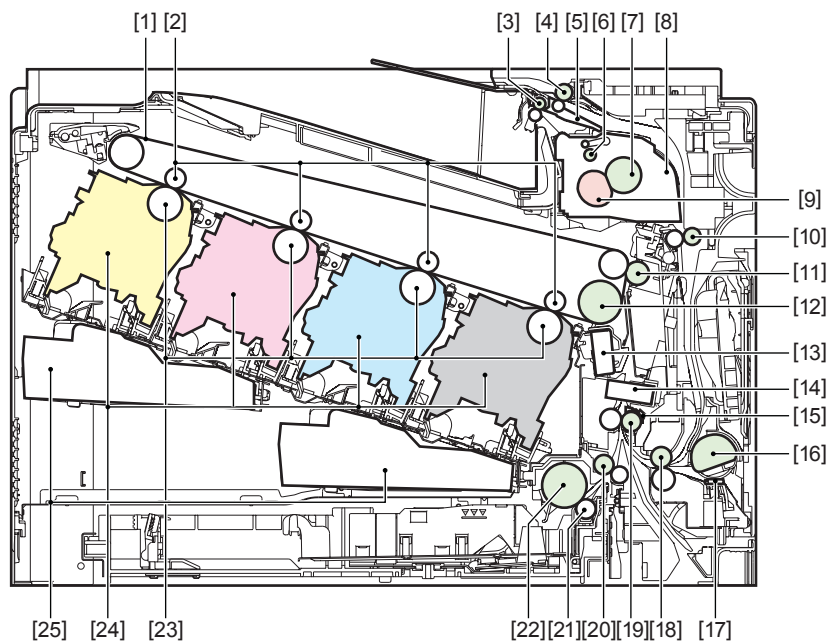

F-1-7

- | | |
|----------------------------------------|----------------------------------------|
| [1] ITB unit | [14] OHT sensor |
| [2] Primary transfer roller | [15] Registration shutter |
| [3] Delivery roller 2 | [16] Multi-purpose tray pickup roller |
| [4] Duplex reverse roller | [17] Multi-purpose tray separation pad |
| [5] Duplex flapper | [18] Duplex re-pickup roller |
| [6] Delivery roller 1 | [19] Registration roller |
| [7] Pressure roller | [20] Feed roller |
| [8] Fixing assembly | [21] Cassette separation roller |
| [9] Fixing sleeve unit | [22] Cassette pickup roller |
| [10] Duplex feed roller | [23] Photosensitive drum |
| [11] Secondary transfer outer roller | [24] Toner cartridge |
| [12] ITB drive roller | [25] Laser scanner unit |
| [13] Color displacement/density sensor | |

Operation

Control Panel

LBP7750C/LBP5460

The control panel consists of lamps and displays showing the printer condition and operation keys.

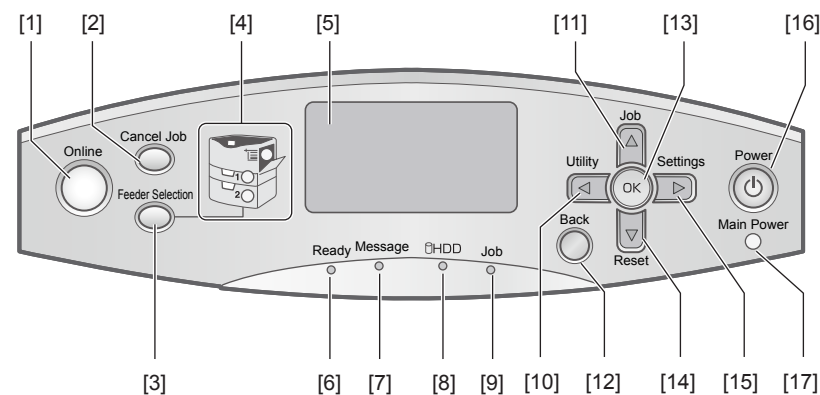

F-1-8

- | | |
|-------------------------------------|---------------------------------------------|
| [1] Online indicator / key | [10] Utility key |
| [2] Job confirmation / cancel key | [11] Job key |
| [3] Pickup selection key | [12] Return key |
| [4] Pickup origination display lamp | [13] OK key |
| [5] Control panel display | [14] Reset key |
| [6] Printable lamp | [15] Setup key |
| [7] Message lamp | [16] Control panel power switch (Sub power) |
| [8] HDD lamp | [17] Main power lamp (Green) |
| [9] Job lamp | |

Lamp

No.	Name	Condition	
[1]	Online (Green)	Lighting	The printer is in the on-line condition (Print data can be received from the computer in this condition). When the printer is placed in the sleep mode, the on-line lamp lights off even if the printer is in the on-line condition.
[4]	Pickup origination display (Green)	Lighting	The pickup assembly is selected.
		Flashing	No paper is set and printing cannot be performed. The pickup cassette is not installed. (When the multi-purpose tray is used, the lamp lights up even when no paper is set.)
[6]	Printable	Lighting	Printing can be performed.
		Flashing	Preparation for printing or calibration is performed.
[7]	Message (Orange)	Lighting	A trouble occurred and printing cannot be performed. (When the printer is placed in the sleep mode in the off-line condition, the message lamp lights up even if no trouble occurs.)
[8]	HDD (Green)	Lighting	Reading/writing is performed in the hard disk.
[9]	Job (Green)	Lighting	Data is being received. Data remains in the printer memory.
		Flashing	Data processing is being performed.
[17]	Main power (Green)	Lighting	The power is turned on.

T-1-6

Control Panel Key

No.	Name	Function	
[1]	On-line	The on-line and off-line conditions are switched. When the key lights up, the printer is placed in the on-line condition. When the key lights off, the printer is in the off-line condition.	
[2]	Job confirmation/cancel	On-line	When this key is pressed in the condition where the job lamp lights up or flashes (data processing being performed/data being received), a list of jobs is displayed. You can select a job from the list and cancel it.
		Off-line	
		Displaying the menu	Not available
[3]	Pickup selection	On-line	The pickup selection menu is displayed. The setting of whether printing is performed from the pickup cassette or the multi-purpose tray, or that of the paper size is made.
		Off-line	
		Displaying the menu	Not available
[10]	Utility	On-line	The utility menu is displayed. Internal information such as current setting of the printer, etc., is printed.
		Off-line	Not available
		Displaying the menu	The printer returns to the previous level.
[11]	Job	On-line	The job menu is displayed. Operation of jobs saved in Secure Print or Box and various list of operation history are printed.
		Off-line	Not available
		Displaying the menu	An upper item in the same level is selected. When a numeric value is selected, the value increases. When the key is kept pressed, the speed of increasing the value becomes faster for some items.
[12]	Return	On-line	Not available
		Off-line	
		Displaying the menu	The printer returns to the previous level.
[13]	OK	On-line	Not available
		Off-line	
		Displaying the menu	The selected item is executed. Or, the printer goes to the next level.

No.	Name	Function	
[14]	Reset	On-line	The reset menu is displayed. Printer reset operation, discharging of printing data, and shutdown operation are performed.
		Off-line	
	Displaying the menu	The lower item in the same level is selected. When a numeric value is selected, the value decreases. When the key is kept pressed, the speed of decreasing the value becomes faster for some items.	
[15]	Setup	On-line	The setup menu is displayed. The printing environment such as layout adjustment or enlargement/reduction can be set.
		Off-line	
	Displaying the menu	The selected item is executed. Or, the printer goes to the next level.	
[16]	Power	When "Sleep Mode" is set to other items than "Not used", the printer is placed in the sleep mode.	

T-1-7

■ LBP7780C/LBP5480

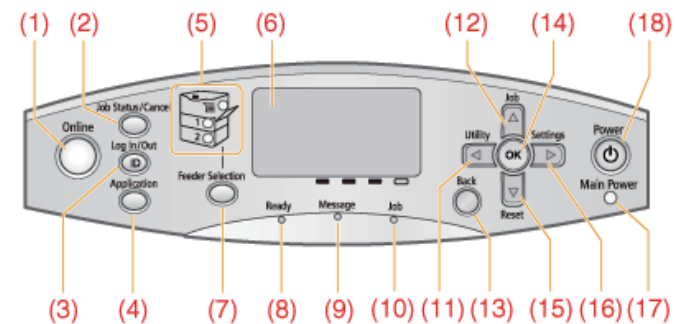

F-1-9

[1]	Online Indicator	[10]	Job Indicator
[2]	Job Status/Cancel	[11]	Utility
[3]	Log In/Out	[12]	Job
[4]	Application	[13]	Back
[5]	Paper Source indicators	[14]	OK
[6]	Control panel display	[15]	Reset
[7]	Feeder Selection	[16]	Settings
[8]	Ready Indicator	[17]	Main Power Indicator
[9]	Message Indicator	[18]	Power

LAMP

No	Name	Condition	
(1)	Online Indicator	Lighting	Online (The printer can receive print data from the computer.) If the printer enters Sleep Mode, the Online indicator is off even when the printer is online.
(5)	Paper Source indicators	Lighting	A paper source is selected.
		Blinking	Printing cannot be performed because no paper is loaded. The paper drawer is not installed. (For the multi-purpose tray, the indicator comes on even when no paper is loaded.)
(8)	Ready Indicator	Lighting	The printer is ready to print.
		Blinking	The printer is preparing to print.
(9)	Message Indicator	Lighting	A problem has occurred and printing cannot be performed. (If the printer enters Sleep Mode when it is offline, the Message indicator comes on even when no problem is occurring.)
(10)	Job Indicator	Lighting	The printer is receiving data. Data remains in the printer memory.
		Blinking	The printer is processing data.
(17)	Main Power Indicator	Lighting	The power of the printer is ON.

Control Panel key

No	Name	Function	
(1)	Online	Switches between online and offline. The printer is online when the indicator under the key is on and is offline when the indicator is off. This key is indicated as (Online) in this manual.	
(2)	Job Status/Cancel	When the printer is online	If pressed when the Job indicator is on or blinking (When data is being processed or received), displays the job list. Select a job from the list to cancel the job.
		When the printer is offline	This key is indicated as (Job Status/Cancel) in this manual.
		While the menu is displayed	Does not function.
(3)	Log In/Out	This key cannot be used. If you press this key, a beep sounds, but no function is assigned to the key.	
(4)	Application	It will transition to the Menu Screen. Whenever the key is pressed, the Printing Screen switches to USB Direct Print. If department ID management is set and you are not logged in to the printer, the log in screen before the USB Direct Print display is displayed.	
(7)	Feeder Selection	When the printer is online	Displays the [Select Feeder] menu. Specify which paper source is used to print between the paper drawer and multi-purpose tray and the paper size. This key is indicated as (Feeder Selection) in this manual.
		When the printer is offline	Does not function.
		While the menu is displayed	
(11)	Utility	When the printer is online	Displays the [Utility Menu] menu. Prints information about the printer settings including the current settings. This key is indicated as (Utility) in this manual.
		When the printer is offline	Does not function.

No	Name	Function	
(11)		While the menu is displayed	Goes back up the previous hierarchy. This key is indicated as [◀] in this manual.
(12)	Job	When the printer is online	Displays the [Job] menu. You can print various log lists. This key is indicated as (Job) in this manual.
		When the printer is offline	Does not function.
		While the menu is displayed	Selects the next upper item in the same hierarchy. When the setting value is numeric, increases the value. If you keep holding down the key, the speed of the value increasing is increased depending on the item. This key is indicated as [▲] in this manual.
(13)	Back	When the printer is online	Does not function.
		When the printer is offline	
		While the menu is displayed	Goes back up the previous hierarchy. This key is indicated as (Back) in this manual.
(14)	OK	When the printer is online	Does not function.
		When the printer is offline	
		While the menu is displayed	Executes the selected item. Otherwise, goes down the hierarchy. This key is indicated as [OK] in this manual.
(15)	Reset	When the printer is online	Displays the [Reset] menu. Performs the printer reset operation, the print data output, and the shutdown operation. This key is indicated as (Reset) in this manual.
		When the printer is offline	
		While the menu is displayed	Selects the next lower item in the same hierarchy. When the setting value is numeric, reduces the value. If you keep holding down the key, the speed of the value decreasing is increased depending on the item. This key is indicated as [▼] in this manual.

No	Name	Function	
(16)	Settings	When the printer is online	Displays the [Setup] menu. Configure the printing environment including the layout adjustment and scaling print output. This key is indicated as (Settings) in this manual.
		When the printer is offline	
		While the menu is displayed	Goes down the hierarchy. This key is indicated as [▶] in this manual.
(18)	Power	When the printer is online	If [Sleep Mode] is set to a setting other than [Off], the printer enters Sleep Mode.
		When the printer is offline	
		While the menu is displayed	This key is indicated as (Power) in this manual.

Job Menu

Setting Items

	Setting	Setting Value
Job Menu	Encrypted Print ^{*1}	-
	Secured Print ^{*1}	-
	Stored Job List ^{*1}	-
	Stored Job Print ^{*1}	-
	Job Print Log List	-
	Stored Job Print Log ^{*1}	-
	Report Print Log	-
	E-mail Print Log	-

T-1-8

- Items and setting values with "**1" may not be displayed depending on the model, presence/absence of options, or contents of other setting items.

Setup Menu

Control Menu Options (LBP7750C/LBP5460)

Setting	Setting Value
Power Save Mode	[On] [*] , [Deep Sleep], [Off], [Panel Off]
Power Save in Error	[On] [*] , [Off]
Power Save Time	
When not using a hard disk	[1 minute] [*] , [5 minutes], [10 minutes], [15 minutes], [30 minutes], [60 minutes], [180 minutes]
When using a hard disk	[5 minutes] [*] , [10 minutes], [15 minutes], [30 minutes], [60 minutes], [180 minutes]
Timer Settings	
Wake Up Timer	[Off] [*] , [On]
Wake Up Time	<ul style="list-style-type: none"> • When [AM/PM] is selected in [12/24 Hour Clock]: 00:00:00 AM/PM to 11:59:59 AM/PM • When [24 Hour] is selected in [12/24 Hour Clock]: 00:00:00 to 23:59:59
Power Save Timer	[Off] [*] , [On]
Power Save Time	<ul style="list-style-type: none"> • When [AM/PM] is selected in [12/24 Hour Clock]: 00:00:00 AM/PM to 11:59:59 AM/PM • When [24 Hour] is selected in [12/24 Hour Clock]: 00:00:00 to 23:59:59
Calibration Timer	[Off] [*] , [On]
Calibration Time	<ul style="list-style-type: none"> • When [AM/PM] is selected in [12/24 Hour Clock]: 00:00:00 AM/PM to 11:59:59 AM/PM • When [24 Hour] is selected in [12/24 Hour Clock]: 00:00:00 to 23:59:59
Warning Step	
Check Toner	[Continue Printing] [*] , [Stop Printing]
Auto Error Skip	[Off] [*] , [On]
Panel Language	[English] [*] , [Español], [Français], [Italiano], [Deutsch]
Alarm	[On] [*] , [Off]
Show Warnings	
Check Toner	[On] [*] , [Off]
Check Waste Tnr Ctn	[On] [*] , [Off]
Cassette Empty	[On] [*] , [Off]
E-mail Trans. Error	[On] [*] , [Off]

Setting	Setting Value
Date and Time	
Date Settings	01/01/2001 to 31/12/2089
12/24 Hour Clock	[AM/PM]*, [24 Hour]
Time Settings	<ul style="list-style-type: none"> When [AM/PM] is selected in [12/24 Hour Clock]: 00:00:00 AM/PM to 11:59:59 AM/PM When [24 Hour] is selected in [12/24 Hour Clock]: 00:00:00 to 23:59:59
Daylight Saving Time	[DST Settings]: [Off]*, [On] [Start Date and Time]: <Month>, <Week>, <Day>, <Time Settings> [End Date and Time]: <Month>, <Week>, <Day>, <Time Settings>
Time Zone	GMT-12 to GMT+12
Hard Disk ^{*1}	[On]*, [Off]
Interrupt Print ^{*1}	[On]*, [Off]
Securing Time ^{*1}	[1 hour]*, [2 hours], [3 hours], [6 hours], [12 hours], [24 hours]
Secured Type ^{*1}	[Image]*, [PDL] ^{*1}
RIP Once ^{*1}	[On]*, [Off]
Assure Job Log ^{*1}	[Off]*, [On]
PDL Select (PnP) ^{*1}	[UFR II]*, [PCL5C], [PCL6], [PS3] ^{*1}
Adjust Screen	
Contrast	-3 to 0 to +3
Backlight Brightness	[Level 3]*, [Off], [Level 1], [Level 2]
Animated Instruction	[On]*, [Off]
Show Toner Gauge	[On]*, [Off]

T-1-9

- Items and setting values with "**1" may not be displayed depending on the model, presence/absence of options, or contents of other setting items.
- Setting values with "*" are factory setting values.

Control Menu (LBP7780C/LBP5480)

Setting	Setting Value	
Sleep Mode	High (Deep Sleep) Mid (Printer Sleep) Low (Panel Sleep) Off	
Sleep Even if Error	[On]*, [Off]	
Sleep Migration Time	[5 minutes]*, [10 minutes], [15 minutes], [30 minutes], [60 minutes], [180 minutes]	
Timer Setting	Wake Up Timer	[Off]*, [On]
	Wake Up Time	<ul style="list-style-type: none"> When [AM/PM] is selected in [12/24 Hour Clock]: 00:00:00 AM/PM to 11:59:59 AM/PM When [24 Hour] is selected in [12/24 Hour Clock]: 00:00:00 to 23:59:59
	Auto Reset Time	[2 minutes], [3 minutes], [4 minutes], [5 minutes], [6 minutes], [7 minutes], [8 minutes], [9 minutes]
	Sleep Mode Timer	[Off]*, [On]
	Sleep Mode Time	<ul style="list-style-type: none"> When [AM/PM] is selected in [12/24 Hour Clock]: 00:00:00 AM/PM to 11:59:59 AM/PM When [24 Hour] is selected in [12/24 Hour Clock]: 00:00:00 to 23:59:59
	Calibration Timer	[Off]*, [On]
Warning Step	Calibration Time	<ul style="list-style-type: none"> When [AM/PM] is selected in [12/24 Hour Clock]: 00:00:00 AM/PM to 11:59:59 AM/PM When [24 Hour] is selected in [12/24 Hour Clock]: 00:00:00 to 23:59:59
	Toner Cart Warning	[Continue Printing]* [Stop Printing]
Auto Continue	[Off]*, [On]	
Panel Language	[English]*, [Español], [Français], [Italiano], [中文 (简体)]	
Alarm	[On]*, [Off]	
Show Warnings	Toner Cart.Warning	[On]*, [Off]
	Check Fixing Unit	[On], [Off]*
	Check ITB Unit	[On], [Off]*
	Check Waste Tnr Ctn	[On]*, [Off]
	Drawer Empty	[On]*, [Off]
	E-Mail Trans. Error	[On]*, [Off]

Setting		Setting Value
Date/Time Setting	Date	01/01/2001 to 31/12/2089
	Time (24 hour)	<ul style="list-style-type: none"> When [AM/PM] is selected in [12/24 Hour Clock]: 00:00:00 AM/PM to 11:59:59 AM/PM When [24 Hour] is selected in [12/24 Hour Clock]: 00:00:00 to 23:59:59
	Daylight Savings	[DST Settings]: [Off]*, [On] [Start Date/Time]: <Month>, <Week>, <Day>, <Time Settings> [End Date/Time]: <Month>, <Week>, <Day>, <Time Settings>
	Time Zone	GMT-12 to GMT+12
Select PDL(PnP)	UFR II UFR II XPS PCL5C PCL6 PS3 XPS(Direct)	
Mng Setting	Setting Key Lock	
Adjust Screen	Contrast	-3 to 0 ⁺ to +3
	Backlight Brightness	OFF Level 1 Level 2 Level 3
Animated Instruction	[On] ⁺ , [Off]	
Show Toner Gauge	[On] ⁺ , [Off]	
Set Comp. Notify	Off 1 second 2 seconds 3 seconds	
Scrolling Speed	Slow, Normal ⁺ , Fast	

T-1-10

- Items and setting values with "**1" may not be displayed depending on the model, presence/absence of options, or contents of other setting items.
- Setting values with "*" are factory setting values

■ Paper Source Menu Options (LBP7750C/LBP5460)

Setting		Setting Value
MP Tray Paper Size		[LTR]*, [LGL], [EXEC], [Mixed Sizes], [Custom Size], [Custom Size R], [ENV. ISOC5], [ENV. No.10], [ENV. C.G. No.8], [ENV. DL], [ENV. ISO-B5], [STMT], [FLSC], [16K], [A5], [B5], [A4]
MP Tray Priority		[Off] ⁺ , [On]
Cassette 1 Size		[LTR] ⁺ , [EXEC], [Mixed Sizes], [Custom Size], [Custom Size R], [16K], [A5], [B5],[A4]
Cassette 2 Size ^{*1}		[Auto] ⁺ , [Custom Size], [Custom Size R], [16K], [Mixed Sizes]
Standard Paper Size		[LTR]*, [LGL], [EXEC], [ENV. ISO-C5], [ENV. No.10], [ENV. C.G. No.8], [ENV. DL], [ENV. ISO-B5], [STMT], [FLSC], [16K], [A5], [B5], [A4]
Invalid Paper Tray		[Off] ⁺ , [On]
Auto Selection		
	Multi-purpose Tray	[On] ⁺ , [Off]
	Cassette 1	[On] ⁺ , [Off]
	Cassette 2 ^{*1}	[On] ⁺ , [Off]
Standard Paper Type		[Plain Paper]*, [Plain Paper L], [Heavy Paper 1], [Heavy Paper 2], [Transparencies], [Envelope], [Coated Paper 1], [Coated Paper 2], [Coated Paper 3], [Label], [Rough Paper]
MP Tray Paper Type		[Mixed Types]*, [Plain Paper], [Plain Paper L], [Heavy Paper 1], [Heavy Paper 2], [Transparencies], [Envelope], [Coated Paper 1], [Coated Paper 2], [Coated Paper 3], [Label], [Rough Paper]
Cassette 1 Type		[Mixed Types]*, [Plain Paper], [Plain Paper L], [Heavy Paper 1], [Heavy Paper 2], [Coated Paper 1], [Coated Paper 2], [Rough Paper]
Cassette 2 Type ^{*1}		[Mixed Types]*, [Plain Paper], [Plain Paper L], [Heavy Paper 1], [Heavy Paper 2], [Transparencies], [Coated Paper 1], [Coated Paper 2], [Coated Paper 3], [Label], [Rough Paper]
Manual 2-Sided		[1st Side]*, [2nd Side]
2-Sided Printing		[Off]*, [On]

T-1-11

- Items and setting values with "**1" may not be displayed depending on the model, presence/absence of options, or contents of other setting items.
- Setting values with "*" are factory setting values.

Paper Source (LBP7780C/LBP5480)

Setting	Setting Value
Paper Source	[Auto]*, [Drawer 1], [Multi-Purpose Tray]
MP Tray Paper Size	[A6], [A5], [A5R], [B5],[A4]*, [LTR], [LGL], [EXEC], [Mixed Size], [Custom Size], [Custom Size R], [Env. ISO-C5], [Env. Monarch], [Env.No.10], [Env. DL], [Index Card], [STMT], [FLSC], [16K]
MP Tray Priority	[Off], [On]
Drawer 1 Size	[A6], [A5], [A5R], [B5],[A4]*, [LTR], [LGL], [EXEC], [Mixed Size], [Custom Size R], [STMT], [16K]
Standard Paper Size	[A6], [A5], [A5R], [B5],[A4]*, [LTR], [LGL], [EXEC], [Env. ISO-C5], [Env. Monarch], [Env.No.10], [Env. DL], [Index Card], [STMT], [FLSC], [16K]
Diff Paper Tray	[Off], [On]
Auto Selection	
Multi-purpose Tray	[On], [Off]
Drawer 1	[On], [Off]
Default Paper Type	[Plain]*, [Plain L], [Plain L2], [Heavy 1], [Heavy 2], [Heavy 3], [Transparency], [Envelope], [Labels], [Rough]
MP Tray Paper Type	[Envelope], [Labels], [Rough], [Mixtypes]
Drawer 1 Type	[Plain]*, [Plain L], [Plain L2], [Heavy 1], [Heavy 2], [Rough], [Mixed Types]
Manual 2-Sided(MP)	[1st Side]*, [2nd Side]
2-Sided Printing	[Off]*, [On]

T-1-12

- Items and setting values with "*" may not be displayed depending on the model, presence/absence of options, or contents of other setting items.
- Setting values with "*" are factory setting values

Standard Network Menu Options (LBP7750C/LBP5460)

Setting	Setting Value	
TCP/IP Settings		
IP v.4 Settings	IP Mode	[Manual], [Auto]
	Protocol ^{**1}	Use DHCP: [Off], [On]
		Use BOOTP: [Off], [On]
		Use RARP: [Off], [On]
	IP Address Settings ^{**1}	IP Address: 0.0.0.0
		Subnet Mask: 0.0.0.0
		Gateway Address: 0.0.0.0
	IP Address Range	Reject Receive/Print: [Off], [On]
		Reject Address Set. ^{**1} : Reject IP address 1 to 8
		Permit Receive/Print: [Off], [On]
		Permit Address Set. ^{**1} : Permit IP address 1 to 8
		Reject Set/Browse: [Off], [On]
		Reject Address Set. ^{**1} : Reject IP address 1 to 8
DNS	Permit Set/Browse: [Off], [On]	
	Permit Address Set. ^{**1} : Permit IP address 1 to 8	
	Primary Address: 0.0.0.0 Secondary Address: 0.0.0.0	
IP v.6 Settings	IPv6: [Off], [On]	
WINS Resolution	[Off], [On]	
ARP/PING	[On], [Off]	
FTP	FTP Print	[Off], [On]
	FTP Settings	[Off], [On]
LPD Print	[On], [Off]	
RAW Print	[On], [Off]	
IPP Print	[On], [Off]	
WSD	WSD Print	[On], [Off]
	WSD Browsing ^{**1}	[On], [Off]
	Multicast Discovery	[On], [Off]
HTTP	[On], [Off]	

Setting		Setting Value
Proxy Settings ^{*1}	Proxy	[Off] [†] , [On]
	Server Address	-
	Port Number	0 to 80 [†] to 99999
	Same Domain	Do Not Use Proxy [†] , Use Proxy
	Proxy Authentication	[Off] [†] , [On]
	User Name	-
	Password	-
SNTP		[Off] [*] , [On]
Response		[On] [*] , [Off]
MAC Address Settings	Permit Receive	[Off] [†] , [On]
	Permit Address Set. ^{*1}	Permit MAC Add. 1 to Permit MAC Add. 50
NetWare Settings		[NetWare]: [Off] [*] , [On] [Frame Type]: [Auto Detect] [*] , [Ethernet II], [Ethernet 802.2], [Ethernet 802.3], [Ethernet SNAP] [Print Service]: [NDS PServer] [*] , [NPrinter], [Bindery PServer], [RPrinter]
AppleTalk		[Off] [†] , [On]
SMB		
SMB Server		[Off] [†] , [On]
SMB ^{*1}		[Off] [†] , [On]
SNMP v.1		[On] [†] , [Off]
SNMP v.3 Settings		
SNMP v.3		[Off] [†] , [On]
User Settings 1 to User Settings 5 ^{*1}		Authent. Password
		Encryption Password
Spooler ^{*1}		[Off] [†] , [On]
Start Wait Time ^{*1}		0 [†] to 300
Remote UI Settings		
Remote UI		[On] [†] , [Off]
SSL		[Off] [†] , [On] ^{*1}
Ethernet Driver ^{*1}		
Auto Detect		[On] [†] , [Off]
Communication Mode ^{*1}		[Half Duplex] [†] , [Full Duplex]
Ethernet Type ^{*1}		[10 Base-T] [†] , [100 Base-TX]

Setting	Setting Value
MAC Address ^{*1}	(Display only)
E-Mail Print Set.	
POP3 Interval	0 [†] to 90
POP3 Receive	[Off] [†] , [On]
SMTP Receive	[Off] [†] , [On]
Initialize Network	-

T-1-13

- Items and setting values with "**1" may not be displayed depending on the model, presence/absence of options, or contents of other setting items.
- Setting values with "***" are factory setting values.

Network (LBP7780C/LBP5480)

Setting		Setting Value
TCP/IP Settings		
IP v.4 Settings	IP v 4	[On] [*] , [Off]
	IP Mode	[Manual] [*] , [Auto]
	IP Address Settings ^{*1}	IP Address: 0.0.0.0
		Subnet Mask: 0.0.0.0
		Gateway Address: 0.0.0.0
	DNS	Primary Address: 0.0.0.0
		Secondary Address: 0.0.0.0
	DHCP Option	Acquire Host Name: [On] [*] , [Off]
DNS Dynamic Update: [Off] [*] , [On]		
IP v.6 Settings		IPv6: [Off] [*] , [On]
WINS Resolution		[Off] [*] , [On]
ARP/PING		[On] [*] , [Off]
FTP	FTP Print	[Off] [*] , [On]
	FTP Settings	[Off] [*] , [On]
LPD Print		[On] [*] , [Off]
RAW Print		[On] [*] , [Off]
IPP Print		[On] [*] , [Off]
WSD	WSD Print	[On] [*] , [Off]
	WSD Browsing ^{*1}	[On] [*] , [Off]
	Multicast Discovery	[On] [*] , [Off]
HTTP		[On] [*] , [Off]
Proxy Settings ^{*1}	Proxy	[Off] [*] , [On]
SNTP		[Off] [*] , [On]
Discovery Response		[On] [*] , [Off]
IPSec		[Off] [*] , [On]
Net Ware Settings		Net Ware: [Off] [*] , [On]
AppleTalk		[Off] [*] , [On]
SNMP v.1 Settings		
SNMP v.1		[On] [*] , [Off]
Dctd Community Set		Dctd Community:[off], [Read/Write], [Read Only] [*]
SNMP v.3 Settings		
SNMP v.3		[Off] [*] , [On]
Network Delay Time		0 [*] to 300

Setting	Setting Value
Remote UI Settings	
Remote UI	[On] [*] , [Off]
SSL	[Off] [*] , [On]
Ethernet Driver ^{*1}	
Auto Detect	[On] [*] , [Off]
IEEE802.1X	
[Off] [*] , [On]	
Address Filter	
[On] [*] , [Off]	
MAC Address	
(Display only)	
E-Mail Print Set	
POP3 RX Interval	0 [*] to 90
POP3 RX	[Off] [*] , [On]
SMTP RX	[Off] [*] , [On]
Init Network Set	
-	

T-1-14

- Items and setting values with "^{*1}" may not be displayed depending on the model, presence/absence of options, or contents of other setting items.
- Setting values with "^{*}" are factory setting values

Layout Menu Options (LBP7750C/LBP5460)

Setting	Setting Value
Copies	1 to 9999
Offset Y	-1.97 to 0.0 to 1.97 (in.)
Offset X	-1.97 to 0.0 to 1.97 (in.)
Binding Location	[Long Edge], [Short Edge]
Gutter	-1.97 to 0.0 to 1.97 (in.)
Alternative Method	[Off], [On]

T-1-15

- Items and setting values with "*" may not be displayed depending on the model, presence/absence of options, or contents of other setting items.
- Setting values with "*" are factory setting values.

Layout (LBP7780C/LBP5480)

Setting	Setting Value
Copies	1 to 9999
Offset Y	-1.97 to 0.0 to 1.97 (in.)
Offset X	-1.97 to 0.0 to 1.97 (in.)
Binding Location	[Long Edge], [Short Edge]
Gutter	-50 to 0.0 to 50 (in.)
Alternative Method	[Off], [On]

T-1-16

- Items and setting values with "*" may not be displayed depending on the model, presence/absence of options, or contents of other setting items.
- Setting values with "*" are factory setting values.

Quality Menu Options (LBP7750C/LBP5460)

Setting	Setting Value
Gradation Level	[High 1], [High 2]
Toner Save	[Off], [On]
Density: Cyan	-8 to 0 to +7
Density: Magenta	-8 to 0 to +7
Density: Yellow	-8 to 0 to +7
Density: Black	-8 to 0 to +7
Color Mode	[Auto], [Color], [Black and White]

Setting		Setting Value
Halftones		
B & W Halftones	Text	[Resolution], [Gradation], [Color Tone], [High Resolution], [Error Diffusion]
	Graphics	[Gradation], [Color Tone], [High Resolution], [Error Diffusion], [Resolution]
	Image	[Gradation], [Color Tone], [High Resolution], [Error Diffusion], [Resolution]
Color Halftones	Text	[Resolution], [Gradation], [Color Tone], [High Resolution], [Error Diffusion]
	Graphics	[Color Tone], [High Resolution], [Error Diffusion], [Resolution], [Gradation]
	Image	[Color Tone], [High Resolution], [Error Diffusion], [Resolution], [Gradation]
Gray Compensation		
	Text	[On], [Off]
	Graphics	[On], [Off]
	Image	[On], [Off]
CMS		
CMS Selection		[Printer], [Host]
CMS/Gamma	Text	[CMS], [Gamma]
	Graphics	[CMS], [Gamma]
	Image	[CMS], [Gamma]
RGB Source Profile	Text	[sRGB_v1.31]*, [HDTV_gamma_1.5], [HDTV_gamma_1.8], [HDTV_gamma_2.4], [Download Profile] [†]
	Graphics	[sRGB_v1.31], [HDTV_gamma_1.5], [HDTV_gamma_1.8], [HDTV_gamma_2.4], [Download Profile] [†]
	Image	[sRGB_v1.31]*, [HDTV_gamma_1.5], [HDTV_gamma_1.8], [HDTV_gamma_2.4], [Download Profile] [†]
Output Profile	Text	[Normal], [Photo]
	Graphics	[Normal], [Photo]
	Image	[Photo], [Normal]
Matching Method	Text	[Saturation], [Colorimetric], [Perceptual]
	Graphics	[Perceptual], [Saturation], [Colorimetric]
	Image	[Perceptual], [Saturation], [Colorimetric]

Setting		Setting Value
Gamma	Text	[1.4] [*] , [1.8], [2.2], [1.0]
	Graphics	[1.4] [*] , [1.8], [2.2], [1.0]
	Image	[1.4] [*] , [1.8], [2.2], [1.0]
Gradation Settings		
Gradation		[Off] [*] , [Smooth 1], [Smooth 2]
Graphics ^{*1}		[On] [*] , [Off]
Image ^{*1}		[On] [*] , [Off]
Advanced Smoothing		
Advanced Smoothing		[Smooth 1] [*] , [Smooth 2], [Off]
Graphics ^{*1}		[Off] [*] , [On]
Text ^{*1}		[On] [*] , [Off]
Toner Volume Adjust		[Normal] [*] , [Gradation [Priority]], [Text Priority]
Line Control		[Resolution [Priority] [*] , [Gradation Priority]
Quality Change		[Continue Printing] [*] , [Stop Printing]

T-1-17

- Items and setting values with "**1" may not be displayed depending on the model, presence/absence of options, or contents of other setting items.
- Setting values with "*" are factory setting values.

■ Quality (LBP7780C/LBP5480)

Setting	Setting Value
Gradation Level	[High 1] [*] , [High 2]
Toner Save	[Off] [*] , [On]
Density: C	-8 to 0 [*] to +8
Density: M	-8 to 0 [*] to +8
Density: Y	-8 to 0 [*] to +8
Density: K	-8 to 0 [*] to +7
Density: C (Fine Adj)	High [*] , Mid, Low
Density: M (Fine Adj)	High [*] , Mid, Low
Density: Y (Fine Adj)	High [*] , Mid, Low
Density: K (Fine Adj)	High [*] , Mid, Low
Color Mode	Auto(Color/Black) [*] , Color, Black

Setting		Setting Value
Halftones		
Error Diffusion		[Off] [*] , [On]
Resolution/Grad	Text	[On] [*] , [Off]
	Graphics	[On] [*] , [Off]
	Image	[On] [*] , [Off]
Gray Compensation		
Text		[On] [*] , [Off]
Graphics		[On] [*] , [Off]
Image		[On] [*] , [Off]
CMS		
CMS Selection		[Printer] [*] , [Host]
CMS/Gamma	Text	[CMS] [*] , [Gamma]
	Graphics	[CMS] [*] , [Gamma]
	Image	[CMS] [*] , [Gamma]
RGB Source Profile	Text	[sRGB_v3.0(Canon)] [*] , [Canon HDTV_gamma_1.5], [Canon HDTV_gamma_1.8], [Canon HDTV_gamma_2.4]
	Graphics	[sRGB_v3.0(Canon)] [*] , [Canon HDTV_gamma_1.5], [Canon HDTV_gamma_1.8], [Canon HDTV_gamma_2.4]
	Image	[sRGB_v3.0(Canon)] [*] , [Canon HDTV_gamma_1.5], [Canon HDTV_gamma_1.8], [Canon HDTV_gamma_2.4]
Output Profile	Text	[Normal] [*] , [Photo]
	Graphics	[Normal] [*] , [Photo]
	Image	[Photo] [*] , [Normal]
Matching Method	Text	[Saturation] [*] , [Colorimetric], [Perceptual]
	Graphics	[Perceptual] [*] , [Saturation], [Colorimetric]
	Image	[Perceptual] [*] , [Saturation], [Colorimetric]
Gamma	Text	[1.4] [*] , [1.8], [2.2], [1.0]
	Graphics	[1.4] [*] , [1.8], [2.2], [1.0]
	Image	[1.4] [*] , [1.8], [2.2], [1.0]
Gradation Settings		
Gradation		[Off] [*] , [Smooth 1], [Smooth 2]
Graphics ^{**1}		[On] [*] , [Off]
Image ^{**1}		[On] [*] , [Off]
Advanced Smoothing		

Setting		Setting Value
Advanced Smoothing		[Smooth 1] [*] , [Smooth 2], [Off]
Graphics ^{**1}		[Off] [*] , [On]
Text ^{**1}		[On] [*] , [Off]
Toner Volume Corr		[Normal] [*] , [Gradation [Priority]], [Text Priority]
Line Control		[Resolution [Priority] [*] , [Gradation Priority]
Reduce Quality		[Continue Printing] [*] , [Stop Printing]

T-1-18

- Items and setting values with "**1" may not be displayed depending on the model, presence/absence of options, or contents of other setting items.
- Setting values with "***" are factory setting values

Interface Menu Options (LBP7750C/LBP5460)

Setting		Setting Value
Interface Connection	USB	[On] [*] , [Off]
	Network	[On] [*] , [Off]
Mode Timeout		[On] [*] , [Off]
Time ^{*1}		5 to 15 [*] to 300 seconds
Extension Card ^{*1}		-
Connection Recog.		[On] [*] , [Off]
Extended RX Buffer ^{*1}		[Off] [*] , [On]

T-1-19

- Items and setting values with "**1" may not be displayed depending on the model, presence/absence of options, or contents of other setting items.
- Setting values with "*" are factory setting values.

Interface (LBP7780C/LBP5480)

Setting		Setting Value
Interface Selection	USB	[On] [*] , [Off]
	Network	[On] [*] , [Off]
	USB Storage Device	MEAP Driver: [On] [*] , [Off]
Timeout	Timeout	[On] [*] , [Off]
	Timeout Time	5 to 15 [*] to 300 seconds
Connection Recog.		[On] [*] , [Off]
Extended RX Buffer ^{*1}		[Off] [*] , [On]

T-1-20

- Items and setting values with "**1" may not be displayed depending on the model, presence/absence of options, or contents of other setting items.
- Setting values with "*" are factory setting values

User Maintenance Options (LBP7750C/LBP5460)

Setting	Setting Value
Adj. Start Position	
Offset Y (MP Tray)	-0.20 to 0.0 [*] to 0.20 (in.)
Offset X (MP Tray)	-0.09 to 0.0 [*] to 0.09 (in.)
Offset Y (Cass. 1)	-0.20 to 0.0 [*] to 0.20 (in.)
Offset X (Cass. 1)	-0.09 to 0.0 [*] to 0.09 (in.)
Offset Y (Cass. 2) ^{*1}	-0.20 to 0.0 [*] to 0.20 (in.)
Offset X (Cass. 2) ^{*1}	-0.09 to 0.0 [*] to 0.09 (in.)
Offset Y (Duplex)	-0.20 to 0.0 [*] to 0.20 (in.)
Offset X (Duplex)	-0.09 to 0.0 [*] to 0.09 (in.)
Recovery Printing	[On] [*] , [Off]
Check Paper Size	[Off] [*] , [On]
Substitute Size	[Off] [*] , [On]
Special Image Mode	[Off] [*] , [Level 1], [Level 2]
HDD Maintenance ^{*1}	
HDD Data All Erase	[Off] [*] , [On]
Quick Format ^{*1}	-
Standard Format	-
Special Print Mode	
Curl Adjustment	[Off] [*] , [On]
Update Firmware	
USB	-
Standard Network	-
1st Calibration	[After Jobs] [*] , [Immediately]
Paper Feed Method	
Multi-purpose Tray	[Speed Priority] [*] , [Print Side Priority]
Cassette 1	[Speed Priority] [*] , [Print Side Priority]
Cassette 2 ^{*1}	[Speed Priority] [*] , [Print Side Priority]
Adjust Temp.Standby	[Off] [*] , [On]

T-1-21

- Items and setting values with "**1" may not be displayed depending on the model, presence/absence of options, or contents of other setting items.
- Setting values with "*" are factory setting values.

User Maintenance (LBP7780C/LBP5480)

Setting	Setting Value
Adj. Start Position	
Offset Y (MP Tray)	-5 to 0.0 [*] to 5
Offset X (MP Tray)	-2.22 to 0.0 [*] to 2.22
Offset Y (Drawer 1)	-5 to 0.0 [*] to 5
Offset X (Drawer 1)	-2.22 to 0.0 [*] to 2.22
Offset Y (2-Sided)	-5 to 0.0 [*] to 5
Offset X (2-Sided)	-2.22 to 0.0 [*] to 2.22
Recovery Printing	[On] [*] , [Off]
Check Paper Size	[Off] [*] , [On]
Substitute Size	[Off] [*] , [On]
Special Image Mode	[Off] [*] , [Level 1], [Level 2]
Special Print Mode	
Curl Correction	[Off] [*] , [On]
Smooth Plain Paper	[Off] [*] , [On]
Update Firmware	
USB	-
Network	-
First Calibration	[Off] [*] , [After Jobs], [Immediately]
Paper Feed Method	
Multi-purpose Tray	[Speed Priority] [*] , [Print Side Priority]
Drawer 1	[Speed Priority] [*] , [Print Side Priority]
Adjust Standby Temp.	[Off] [*] , [Mode 1], [Mode 2], [Mode 3]
Show Job List	[On] [*] , [Off]
IMPORT/EXPORT	[EXPORT], [IMPORT]

T-1-22

- Items and setting values with "**1" may not be displayed depending on the model, presence/absence of options, or contents of other setting items.
- Setting values with "*" are factory setting values

Print Mode Options (LBP7750C/LBP5460)

Setting	Setting Value
Mode Selection	[Auto Selection] [*] , [PCL], [PS] ^{*1} , [PDF] ^{*1}
Auto Switch	
PCL	[On] [*] , [Off]
PS ^{*1}	[On] [*] , [Off]
PDF ^{*1}	[On] [*] , [Off]
Mode Priority	[None] [*] , [PCL], [PS] ^{*1} , [PDF] ^{*1}

T-1-23

- Items and setting values with "**1" may not be displayed depending on the model, presence/absence of options, or contents of other setting items.
- Setting values with "*" are factory setting values.

Print Mode (LBP7780C/LBP5480)

Setting	Setting Value
Mode Selection	[Auto Selection] [*] , [PCL], [PS] ^{*1} , [PDF] ^{*1} , [XPS] ^{*1}
Auto Select	
PCL	[On] [*] , [Off]
PS ^{*1}	[On] [*] , [Off]
PDF ^{*1}	[On] [*] , [Off]
XPS ^{*1}	[On] [*] , [Off]
Mode Priority	[None] [*] , [PCL], [PS] ^{*1} , [PDF] ^{*1} , [XPS] ^{*1}

T-1-24

- Items and setting values with "**1" may not be displayed depending on the model, presence/absence of options, or contents of other setting items.
- Setting values with "*" are factory setting values

UFR II (LBP7780C/LBP5480)

Setting	Setting Value
Paper Save	[On] [*] , [Off]

T-1-25

PCL (LBP7780C/LBP5480)

Setting	Setting Value
Paper Save	[On] [*] , [Off]
Orientation	Portrait [*] , Landscape
Font Number	0 [*] to 104
Pitch	0.44 to 10 [*] to 99.99
Form Lines	5 to 64 [*] to 128
Character Code	PC8, ROMAN8, ROMAN9, ISOL1, ISOL2, ISOL5, ISOL6, ISOL9, PC775, PC8DN, PC850, PC852, PC858, PC8TK, PC1004, WINL1, WINL2, WINL5, WINBALT, DESKTOP, PSTEXT, LEGAL, ISO4, ISO6, ISO11, ISO15, ISO17, ISO21, ISO60, ISO69, WIN30, MCTEXT, PC864, ARABIC8, WINARB, PC866, ISOCYR, WINCYR, PC851, GREEK8, ISOGRK, PC8GRK, WINGRK, PC862, HEBREW7, HEBREW8, ISOHEB
Custom Size	[Do Not Set] [*] , [Set]
Append CR to LF	-
Enlarge A4 Pre Width	[Off] [*] , [On]

T-1-26

- Items and setting values with "**1" may not be displayed depending on the model, presence/absence of options, or contents of other setting items.
- Setting values with "*" are factory setting values

Imaging (LBP7780C/LBP5480)

Setting	Setting Value
Image Orientation	[Auto] [*] , [Vertical], [Horizontal]
Zoom	[Off] [*] , [Auto]
Print Position	[Auto] [*] , [Center], [Top Left]
Show Warnings	[Off], [Print] [*] , [Panel],
Print E-Mail Text	[On] [*] , [Off]
Limit E-MailPrint	[Off] [*] , [On]
Enlarge Print Area	[Off] [*] , [On]
RGB Source Profile	[sRGB_v3.0(Canon)] [*] , [Canon HDTV_gamma_1.5], [Canon HDTV_gamma_1.8], [Canon HDTV_gamma_2.4]
CMYK Sim. Profile	[Euro Standard v1.00], [Japan Color(Canon)] [*] , [U.S Web Coated v1.0]
Output Profile	[Normal], [Photo] [*]

Setting	Setting Value
Matching Method	[Perceptual] [*] , [Saturation], [Colorimetric]
Halftones	[Resolution], [Gradation] [*] , [Error Diffusion],

- Items and setting values with "**1" may not be displayed depending on the model, presence/absence of options, or contents of other setting items.
- Setting values with "*" are factory setting values

XPS (LBP7780C/LBP5480)

Setting		Setting Value	
Matching Mode		[ICC Profile] [*] , [Gamma]	
ICC Profile Settings			
RGB Source Profile	Text	[sRGB_v3.0(Canon)] [*] , [Canon HDTV_gamma_1.5], [Canon HDTV_gamma_1.8], [Canon HDTV_gamma_2.4]	
	Graphics	[sRGB_v3.0(Canon)] [*] , [Canon HDTV_gamma_1.5], [Canon HDTV_gamma_1.8], [Canon HDTV_gamma_2.4]	
	Image	[sRGB_v3.0(Canon)] [*] , [Canon HDTV_gamma_1.5], [Canon HDTV_gamma_1.8], [Canon HDTV_gamma_2.4]	
	Output Profile		
	Text	[Normal] [*] , [Photo]	
	Graphics	Normal] [*] , [Photo]	
	Image	Normal], [Photo] [*]	
	Matching Method		
	Text	[Perceptual], [Saturation] [*] , [Colorimetric]	
Graphics	[Perceptual] [*] , [Saturation], [Colorimetric]		
Image	[Perceptual] [*] , [Saturation], [Colorimetric]		
Gamma Setting			
Gamma Correction	Text	[1.0], [1.4] [*] , [1.8], [2.2]	
	Graphics	[1.0], [1.4] [*] , [1.8], [2.2]	
	Image	[1.0], [1.4] [*] , [1.8], [2.2]	
Photo Color (CL Only)			
Photo Optimizer PRO		[Off] [*] , [On]	
Red-Eye Correction	Red-Eye Correction	[Off] [*] , [On]	
Face Brightener	Face Brightener	[Off] [*] , [On]	
Halftones			
Error Diffusion		[Off] [*] , [On]	
Resolution/Grad	Text	[Resolution] [*] , [Gradation]	
	Graphics	[Resolution], [Gradation] [*]	
	Image	[Resolution], [Gradation] [*]	
Gray Compensation			
Text		[On] [*] , [Off]	
Graphics		[On] [*] , [Off]	

Setting	Setting Value
Image	[On], [Off]
Advanced Smoothing	
Advanced Smoothing	[Off], [Smooth 1], [Smooth 2]
Graphics	[On], [Off]
Text	[On], [Off]
Grayscale Conversion	
Text	[sRGB], [NTSC], [Uniform RGB]
Graphics	[sRGB], [NTSC], [Uniform RGB]
Image	[sRGB], [NTSC], [Uniform RGB]

- Items and setting values with "*" may not be displayed depending on the model, presence/absence of options, or contents of other setting items.
- Setting values with "" are factory setting values

■ Imaging (LBP7780C/LBP5480)

Setting	Setting Value
Fit to Page	[Off], [On]
Enlarged Print Area	[Off], [On]
N on 1	[Off], [2 on 1], [4 on 1], [6 on 1], [8 on 1], [9 on 1], [16 on 1]
Comment Print	[Off], [Auto]
ICC Profile Settings	
RGB Source Profile	[sRGB_v3.0(Canon)]*, [Canon HDTV_gamma_1.5], [Canon HDTV_gamma_1.8], [Canon HDTV_gamma_2.4], [None]
CMYK Sim. Profile	[Euro Standard v1.00], [Japan Color(Canon)], [U.S Web Coated v1.0], [None]
Grayscale Profile	[Off], [On]
Output Profile	[PS Normal], [PS Photo], [PS TR Normal], [PS TR Photo]
Matching Method	[Perceptual], [Saturation], [Colorimetric]
RGB Pure Black Mode	[On], [Off]
CMYK Pure Black	[On], [Off]
Pure Black Text	[On], [Off]
Black Overprint	[On], [Off]
Brightness	85 to 100 to 115
Halftones	
Error Diffusion	[Off], [On]
Resolution/Grad	Text [Resolution], [Gradation] Graphics [Resolution], [Gradation] Image [Resolution], [Gradation]
CMYK Overprint	[Off], [On]
Advanced Smoothing	
Advanced Smoothing	[Off], [Smooth 1], [Smooth 2]
Graphics	[Off], [On]
Text	[On], [Off]

- Items and setting values with "*" may not be displayed depending on the model, presence/absence of options, or contents of other setting items.
- Setting values with "" are factory setting values

■ PS(LBP7780C/LBP5480)

Setting	Setting Value
Job Timeout	0 to 3600
Print PS Error	[Off], [On]
ICC Profile Settings	
RGB Source Profile	[sRGB_v3.0(Canon)]*, [Canon HDTV_gamma_1.5], [Canon HDTV_gamma_1.8], [Canon HDTV_gamma_2.4], [None]
CMYK Sim. Profile	[Euro Standard v1.00], [Japan Color(Canon)], [U.S Web Coated v1.0], [None]
Grayscale Profile	[Off], [On]
Output Profile	[PS Normal], [PS Photo], [PS TR Normal], [PS TR Photo]
Matching Method	[Perceptual], [Saturation], [Colorimetric]
RGB Pure Black Mode	[On], [Off]
CMYK Pure Black	[On], [Off]
Pure Black Text	[On], [Off]
Black Overprint	[On], [Off]
Brightness	85 to 100 to 115
Halftones	
Error Diffusion	[Off], [On]
Resolution/Grad	Text [Resolution], [Gradation] Graphics [Resolution], [Gradation] Image [Resolution], [Gradation]
CMYK Overprint	[Off], [On]
Advanced Smoothing	
Advanced Smoothing	[Off], [Smooth 1], [Smooth 2]
Graphics	[Off], [On]
Text	[On], [Off]

- Items and setting values with "*" may not be displayed depending on the model, presence/absence of options, or contents of other setting items.
- Setting values with "" are factory setting values

MEAP Setting (LBP7780C/LBP5480)

Setting	Setting Value
Select Def. Screen	
Print Screen	-
MEAP	-

- Items and setting values with "*" may not be displayed depending on the model, presence/absence of options, or contents of other setting items.
- Setting values with "-" are factory setting values

Check Counter (LBP7780C/LBP5480)

Setting	Setting Value
Check Counter	-

Initialize Menu (LBP7780C/LBP5480)

Setting	Setting Value
Initialize Menu	-

Utility Menu (LBP7750C/LBP5460)

Setting	Setting Value
Configuration Page	-
Network Status Print	-
Calibration	[Color Regis. Adjust.], [Density Control], [Density Median Cont.], [Full Calibration]
PCL Utility	[Fonts List]
PS Utility ^{*1}	[Status Print], [Fonts List]
Cleaning	[A4] [*] , [LTR]
Extension Card List ^{*1}	-
E-mail Utility	[Receive E-mails], [Receive Log List]
Printing Pos. Print	-
Page Count List	-
Serial Number	-
Consumables	[Paper Information], [Cartridge], [Remaining Toner], [Waste Toner cntnr], [Waste Toner Status]

T-1-28

- Items and setting values with "*" may not be displayed depending on the model, presence/absence of options, or contents of other setting items.
- Setting values with "-" are factory setting values.

Utility Menu (LBP7780C/5480)

Setting	Setting Value
Check Counter	-
Configuration Page	-
Network Status Print	-
IPSec Policy List	-
Calibration	[Color Mismatch Corr] [*] , [Density Control], [Density Median Cont.], [Full Calibration]
PCL Utility	-
PS Utility ^{*1}	[Configuration Page], [Fonts List]
Cleaning	[A4] [*] , [LTR]
E-mail Print Utility	[Received E-mails], [Received E-mail List]
Printing Pos. Print	-
Page Count List	-
Counter Repotr	-

Setting		Setting Value
Print MEAP Sys. Info		-
Serial Number		-
Consumables	Paper Information	[Multi Purpose Tray], [Drawer 1]
	Toner Cart. Model	[Cyan], [Magenta],[Yellow],[Black]
	Remaining Toner	[Cyan], [Magenta],[Yellow],[Black]
	Waste Toner cntnr	-
	Waste Toner Status	-

T-1-29

- Items and setting values with "**1" may not be displayed depending on the model, presence/absence of options, or contents of other setting items.
- Setting values with "*" are factory setting values

Reset Menu (LBP7750C/LBP5460)

Setting	Setting Value
Soft Reset / Hard Reset	-
Form Feed	-
Shut Down	-

T-1-30

Reset Menu (LBP7780C/LBP5480)

Setting	Setting Value
Soft Reset	-
Form Feed	-
Shut Down	-

T-1-31

Select Feeder Menu (LBP7750C/LBP5460)

Setting	Setting Value
Paper Source	[Auto] [*] , [Cassette 1], [Cassette 2] ^{*1} , [Multi-purpose Tray]
MP Tray Paper Size	[LTR] [*] , [LGL], [EXEC], [Mixed Sizes], [Custom Size], [Custom Size R], ENV. ISOC5], [ENV. No.10], [ENV. C.G. No.8], [ENV. DL], [ENV. ISO-B5], [STMT], [FLSC],]16K], [A5], [B5], [A4]
Cassette 1 Size	[LTR] [*] , [EXEC], [Mixed Sizes], [Custom Size], [Custom Size R], [16K], [A5], [B5], [A4]
Cassette 2 Size ^{*1}	[Auto] [*] , [Custom Size], [Custom Size R], [16K], [Mixed Sizes]
MP Tray Paper Type	[Mixed Types] [*] , [Plain Paper], [Plain Paper L], [Heavy Paper 1], [Heavy Paper 2], [Transparencies], [Envelope], [Coated Paper 1], [Coated Paper 2], [Coated Paper 3], [Label], [Rough Paper]
Cassette 1 Type	[Mixed Types] [*] , [Plain Paper], [Plain Paper L], [Heavy Paper 1], [Heavy Paper 2], [Coated Paper 1], [Coated Paper 2], [Rough Paper]
Cassette 2 Type ^{*1}	[Mixed Types] [*] , [Plain Paper], [Plain Paper L], [Heavy Paper 1], [Heavy Paper 2], [Transparencies], [Coated Paper 1], [Coated Paper 2], [Coated Paper 3], [Label], [Rough Paper]
2-Sided Printing	[Off] [*] , [On]

T-1-32

- Items and setting values with "**1" may not be displayed depending on the model, presence/absence of options, or contents of other setting items.
- Setting values with "*" are factory setting values.

Select Feeder (LBP7780C/5480)

Setting	Setting Value
Paper Source	[Auto], [Drawer 1] [*] , [Multi-purpose Tray]
MP Tray Paper Size	[A6], [A5], [A5R], [B5], [A4] [*] , [LTR], [LGL], [EXEC], [Mixed Sizes], [Custom Size], [Custom Size R], [Env. ISO-C5], [Env. Monarch], [Env. No.10], [ENV. DL], [Index Card], [STMT], [FLSC],]16K]
MP Tray Priority	[Off] [*] , [On]
Drawer 1 Size	[A6], [A5], [A5R], [B5], [A4] [*] , [LTR], [EXEC], [Mixed Sizes], [Custom Size], [Custom Size R],[STMT],]16K]
Standard Paper Size	[A6], [A5], [A5R], [B5], [A4] [*] , [LTR], [LGL], [EXEC], [Env. ISO-C5], [Env. Monarch], [Env. No.10], [ENV. DL], [Index Card], [STMT], [FLSC],]16K]
Diff.Paper Tray	[Off] [*] , [On]

Setting		Setting Value
Auto Selection	Multi-Purpose Tray	[On] [*] , [Off]
	Drawer 1	[On] [*] , [Off]
Default Paper Type		[Plain] [*] , [Plain L], [Plain L2], [Heavy 1], [Heavy 2], [Heavy 3], [Transparency], [Labels], [Rough]
MP Tray Paper Type		[Envelope], [Labels], [Rough], [Mixed Types] [*]
Drawer 1 Type		[Heavy 1], [Heavy 2], [Rough], [Mixed Types] [*]
Manual 2-Sided (MP)		[1st Side] [*] , [2nd Side]
2-Sided Printing		[Off] [*] , [On]

T-1-33

- Items and setting values with "**1" may not be displayed depending on the model, presence/absence of options, or contents of other setting items.
- Setting values with "*" are factory setting values

Application (LBP7780C/LBP5480)

Setting		Setting Value		
USB Print Setting				
PDF/XPS Default Set	No. of Copies	1 to 9999 (1 [*])		
	Color Mode	[Auto(Color/Black)] [*] , [Black]		
	2-Sided Printing	[Off] [*] , [On]		
	Binding Location	[Long Edge], [Short Edge]		
	Select Paper	[Auto], [Drawer 1A4] [*] , [Option Feeder A4]		
	Halftones	Error Diffusion	[Off] [*] , [On]	
		Resolution/ Gradation	Text	[Resolution] [*] , [Gradation]
			Graphics	[Resolution], [Gradation] [*]
		Image	[Resolution], [Gradation] [*]	
	JPEG/TIFF Def. Set	No. of Copies	1 to 9999 (1 [*])	
Color Mode		[Auto(Color/Black)] [*] , [Black]		
2-Sided Printing		[Off] [*] , [On]		
Binding Location		[Long Edge], [Short Edge]		
Select Paper		[Drawer 1A4] [*] , [Option Feeder A4]		
Halftones		[Error Diffusion] [*] , [Resolution], [Gradation]		
Zoom		[Off] [*] , [Auto]		
Enlarge Print Area		[Off] [*] , [On]		
Image Orientataion		[Auto] [*] , [Vertical], [Horizontal]		
Print Position		[Auto] [*] , [Center], [Top Left]		
File Sort Def. Set		Name(Ascending)		
		Name(Descending)		
		Date/Time(Ascend)		
		Date/Time(Descend)		

T-1-34

Safety Precautions

Laser Safety

Laser beam radiation sometimes causes a danger to human body. To prevent such a danger, the optical laser system used in this machine is hermetically closed by the protection housing and external cover so that a laser beam does not leak to outside. Therefore, a laser beam does not leak out of this machine as long as a user operates the machine in an ordinary manner.

CDRH Regulation

CDRH (Center for Devices and Radiological Health), which belongs to Food and Drug Administration in USA, put a regulation concerning laser products on August 2, 1976. This regulation is applied to laser products manufactured on and after August 1, 1976, and sales activities are prohibited in USA without receiving permission under the regulation. The following figure shows the label indicating that permission has been received under the CDRH regulation, and it is obliged to attach it on all products sold in USA.

CANON INC.

30-2,SHIMOMARUKO,3-CHOME,OHTA-KU,TOKYO,
146.JAPAN

MANUFACTURED :

THIS PRODUCT CONFORMS WITH DHHS RADIATION
PERFORMANCE STANDARD 21CFR CHAPTER I
SUBCHAPTER J.

Caution :

A part of the description may be different depending on the type of product model.

Toner Safety

About Toner

Toner is a nontoxic substance which consists of plastic, iron, and a small amount of pigment.

Caution :

Be sure not to throw toner into the fire. Doing so may cause an explosion.

How to Handle Adhered Toner

- When toner adhered to skin or clothes, completely remove it with dried tissue and wash with water.
- If hot water is used, toner cannot be removed because it becomes gel and penetrates into clothes permanently.
- Do not make toner come into contact with vinyl because it easily reacts with a vinyl material.

Remedy against toner spill

- When you spilled toner, be sure to sweep toner dust while paying attention not to inhale it, or wipe off it with wet cloth, etc.
- When using a vacuum cleaner, be sure to use one specially designed to suction toner dust.

How to Handle the Laser Scanner Unit

An invisible laser beam is irradiated in the laser scanner unit.

If the laser beam enters an eye, it may cause damage to the eye. So, be sure not to disassemble the laser scanner unit. No adjustment can be made to the laser scanner unit in this machine in the field.

The label shown in the following figure is attached to the bottom of the laser scanner unit.

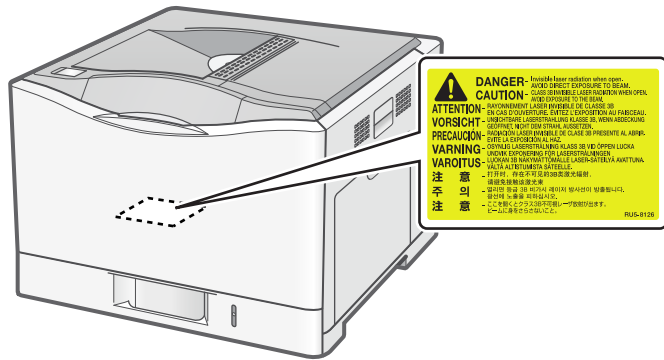

Points to Note when Replacing/Discarding a Lithium Battery

The main controller PCB in this machine contains a lithium battery as backup power supply for various data just in the case when a blackout occurs or the power plug is removed.

Caution :

If the battery is replaced with an incorrect type of battery, it may cause an explosion.

Discard a used battery according to the instruction manual.

Points to Note when Performing Disassembly/Assembly

Be sure to follow the instruction shown below when performing disassembly/assembly.

1. Be sure to unplug the power plug for safety when performing disassembly/assembly.
2. If not otherwise specified, perform assembly in the procedure opposite to that of disassembly.
3. Perform assembly using correct types of screws, etc. (length/diameter) at correct positions.
4. A washer screw is used as a screw to fix a grounding wire and varistor, etc., to secure electrical conduction. Be sure to use this screw when performing assembly.
5. In principle, do not operate the machine in the condition where parts are removed.
6. Do not remove a paint-locked screw when performing disassembly.

Handhabung des Laserteils

F-1-10

Bei Servicearbeiten am oder in der Nähe des Laserteils zuerst das Hauptgerät abschalten.

Bei Servicearbeiten, die unbedingt bei eingeschaltetem Gerät durchgeführt werden müssen, auf jeden Fall die folgenden Vorsichtsmaßnahmen beachten.

- Keine stark reflektierenden Schraubenzieher oder ähnliche Werkzeuge direkt in den Lichtpfad des Laserstrahls bringen.
- Vor Beginn der Arbeit Uhren, Ringe und ähnliche Gegenstände abnehmen. (Reflektierte Laserstrahlen könnten sonst in die Augen geraten.)

Abdeckungen, die möglicherweise Laserstrahlen reflektieren, haben in der auf dem Bild gezeigten Position einen Aufkleber. Bei Servicearbeiten auf der Innenseite von Abdeckungen mit Aufkleber ist besondere Vorsicht erforderlich.

F-1-11

2

Technical Reference

- Basic Configuration
- Operation Sequence
- Laser Exposure System
- Image Formation System
- Fixing System
- Pickup Feeding System
- Controller System
- MEAP
- Embedded RDS

Basic Configuration

Functional Configuration

The function of this machine is broadly classified into the following five blocks.

- Controller system
- Laser exposure system
- Image formation system
- Fixing system
- Pickup feeding system

The following figure shows the block category of the function.

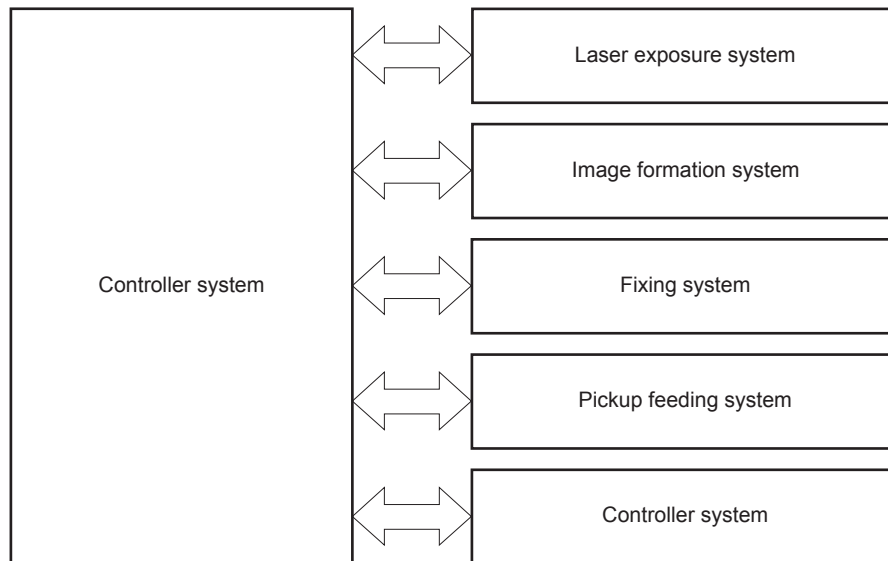

F-2-1

Operation Sequence

Overview

Operation sequence is controlled by the DC controller contained in the controller system. The following shows operation in each interval from when the power of this machine is turned on to when printing is completed and each motor stops.

Interval		Operation
WAIT (Wait)	An interval from when the power switch is turned on, the door is closed, or sleep mode is cancelled to when the printer is ready to perform printing	Start up this machine so that printing can be performed. <ul style="list-style-type: none"> • Heat up the fixing sleeve in the fixing assembly. • Detect the presence of each cartridge and unit. • Move the ITB and developing assembly to the home position. • Perform ITB cleaning and secondary transfer outer roller cleaning
STBY (Standby)	An interval from when WAIT or last rotation finishes to when the print instruction command is entered or the power switch is turned off	Maintain this machine so that printing can be performed. <ul style="list-style-type: none"> • Make the machine move to the sleep status by the sleep instruction command. • Start control by the calibration execution command.
INTR (Initial rotation)	An interval from when the print instruction command is entered to when pickup is performed	Make preparation to perform printing. <ul style="list-style-type: none"> • Operate the high-voltage power supply. • Operate the laser scanner unit. • Start up the fixing assembly.
PRNT (Print)	An interval from when initial rotation finishes to when fixing of the last paper finishes	Execute printing. <ul style="list-style-type: none"> • Form an image on the photosensitive drum. • Transfer toner into paper. • Fix toner on paper.
LSTR (Last rotation)	An interval from when printing finishes to when each motor stops	Deliver the last paper. <ul style="list-style-type: none"> • Stop the high-voltage power supply. • Stop the laser scanner unit. When the print command is entered, the machine moves to the initial rotation state after last rotation finishes.

T-2-1

Laser Exposure System

Overview

The laser exposure system forms a latent image on the photosensitive drum according to the video signal sent from the main controller.

The laser scanner unit consists of the laser unit and the scanner motor unit. Each unit is controlled by the signal entered from the DC controller.

Two laser scanner units are used in this machine. One is a unit for Y/M, and the other is for C/Bk, which are common units.

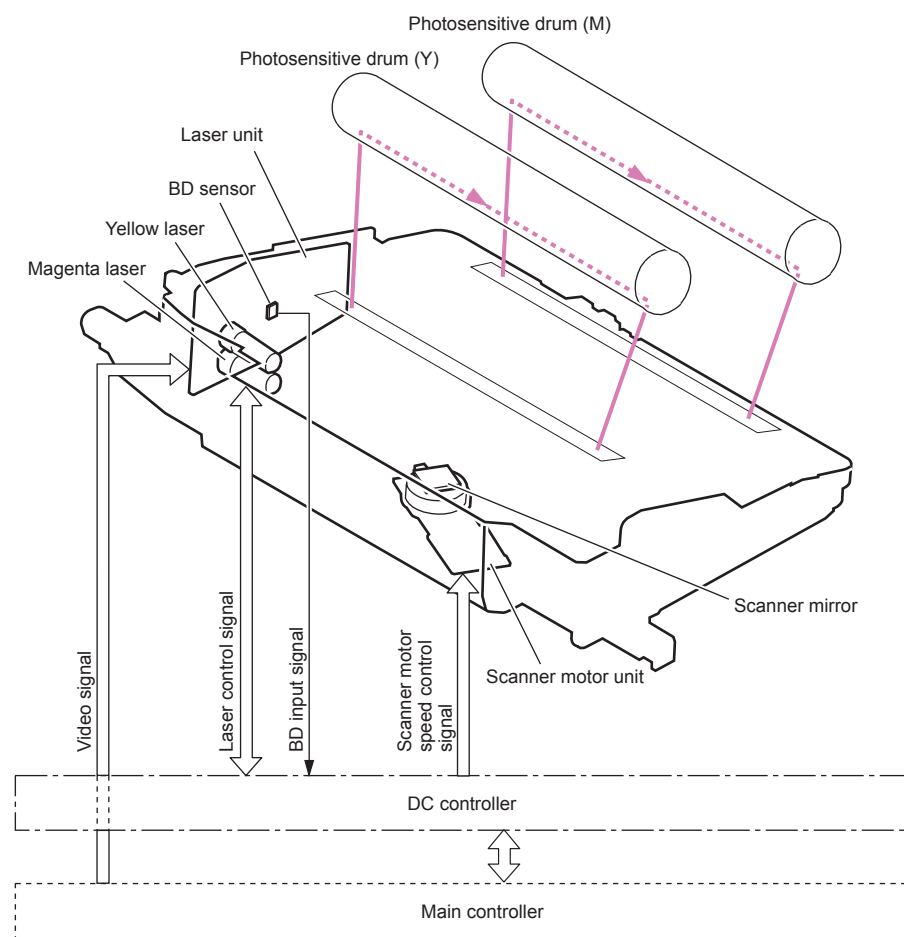

F-2-2

One laser scanner unit consists of the laser drive unit, which controls the laser unit, and the scanner motor unit, which controls the scanner motor. One scanner motor and scanner mirror reflect laser beams for two colors.

These parts are contained in the laser scanner unit and controlled by the DC controller.

The DC controller irradiates each laser beam according to the video signal received from the main controller. The laser beam falls on the scanner mirror rotating at constant speed. The laser beam reflected from the scanner mirror is irradiated on the photosensitive drum.

Detecting a Failure in the Optical Assembly

When the laser scanner is placed in the following condition, the DC controller judges that a failure occurred in the laser scanner unit and reports it to the main controller.

- **Laser failure**
When the laser is turned on for a specified time at startup of the laser scanner unit, either of the two laser beams does not reach the specified laser intensity.
- **Scanner motor startup failure**
Even when a specified time elapses after startup of the laser scanner unit, the number of rotations of the scanner motor does not reach a specified number of times.
- **Scanner motor rotation failure**
When a specified BD interval cannot be detected during printing, it is judged that a BD error occurred. When the BD interval cannot recover from the fault even after a specified time elapsed after it was judged that a BD error occurred, it is considered that a scanner motor rotation failure occurred.

Safety

The laser scanner unit of this machine does not have a mechanical laser shutter.

To secure safety, two interlock switches for +5VC are mounted. When the front door or right door is opened, the interlock switch works and blocks power distribution to the laser scanner unit.

Image Formation System

Overview

The image formation system forms a toner image on paper.

The system consists of the following components.

- Four cartridges
- ITB unit
- Fixing assembly
- Laser scanner unit

The DC controller controls the laser scanner unit and high-voltage power supply PCB(upper/lower), forms a toner image on the photosensitive drum based on a video signal, and transfers/fixes the image on paper via the ITB unit.

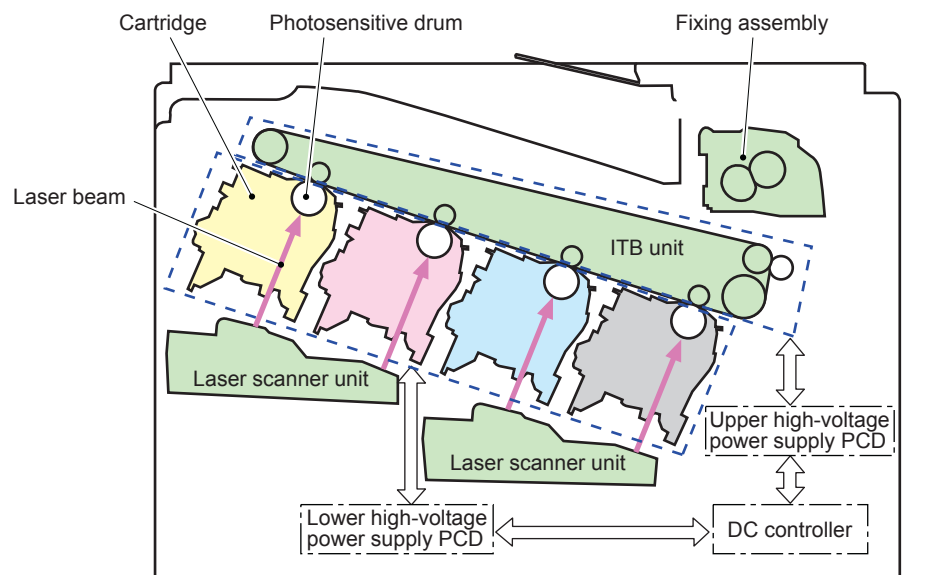

F-2-3

Image Formation Process

Overview

The image formation process of this machine is broadly classified into six blocks and ten steps.

1. Static latent image formation block
 - Step 1: Pre-exposure
 - Step 2: Primary charging
 - Step 3: Laser beam exposure
2. Development block
 - Step 4: Development
3. Transfer block
 - Step 5: Primary transfer
 - Step 6: Secondary transfer
 - Step 7: Separation
4. Fixing block
 - Step 8: Fixing
5. ITB cleaning block
 - Step 9: ITB cleaning
6. Photosensitive drum cleaning block
 - Step 10: Photosensitive drum cleaning

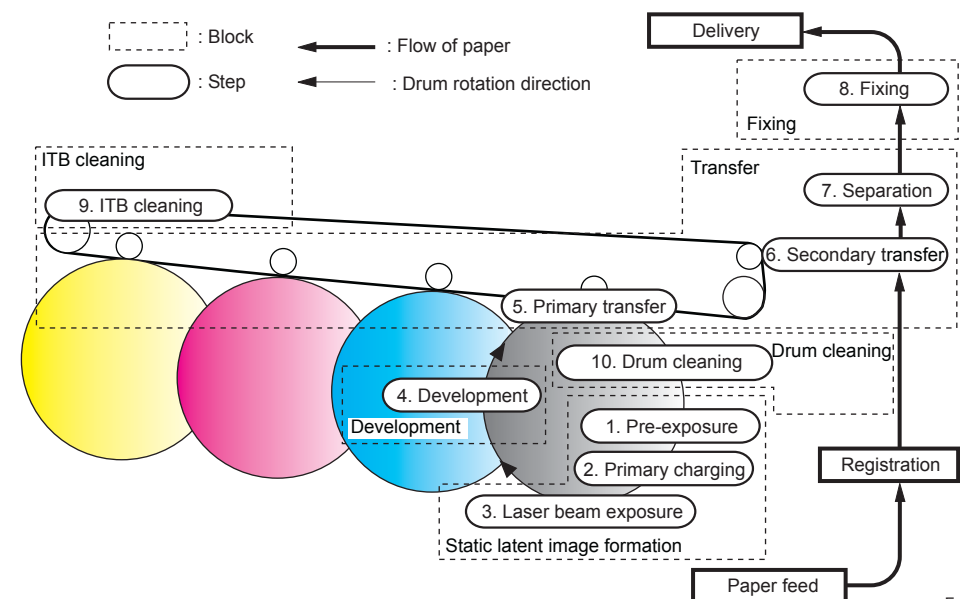

F-2-4

Static Latent Image Formation Block

This block consists of three steps. A static latent image is formed on the photosensitive drum.

Step 1: Pre-exposure

As preparation for primary charging, the light received from the pre-exposure LED is irradiated on the surface of the photosensitive drum. This step eliminates residual charges on the surface of the photosensitive drum.

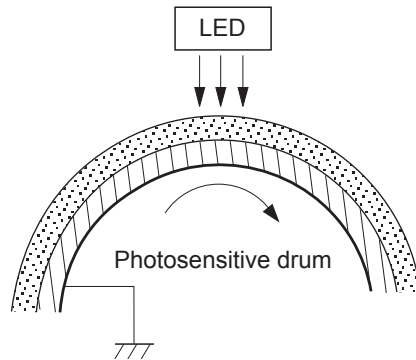

F-2-5

Step 2: Primary Charging

As preparation for latent image formation, the surface of the photosensitive drum is charged with a negative uniform potential.

Primary charging is performed with the charging method in which the primary charging roller directly applies charges to the photosensitive drum.

To keep a uniform potential on the surface of the photosensitive drum, a negative DC bias is applied to the primary charging roller.

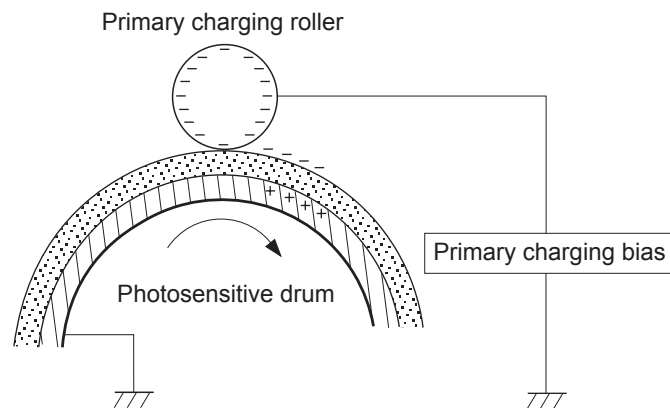

F-2-6

Step 3: Laser Beam Exposure

A static latent image is formed on the photosensitive drum by a laser beam.

When a laser beam scans on the negative-charged photosensitive drum, charges are neutralized (a negative potential is removed) and the scanned area becomes a static latent image.

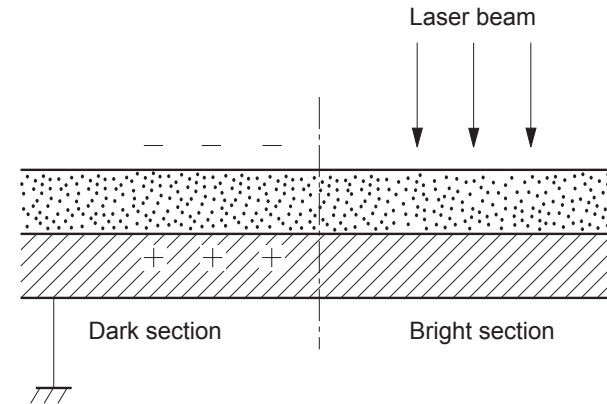

F-2-7

Development Block

In this block, toner is applied on the static latent image on the surface of the photosensitive drum and visualized.

Step 4: Development

Toner adheres to the static latent image on the surface of the photosensitive drum.

The toner is charged with a negative potential by friction on the surface of the developing roller and developing blade.

When the negative-charged toner comes into contact with the photosensitive drum, it adheres to the static latent image caused by a potential difference and becomes a visible image.

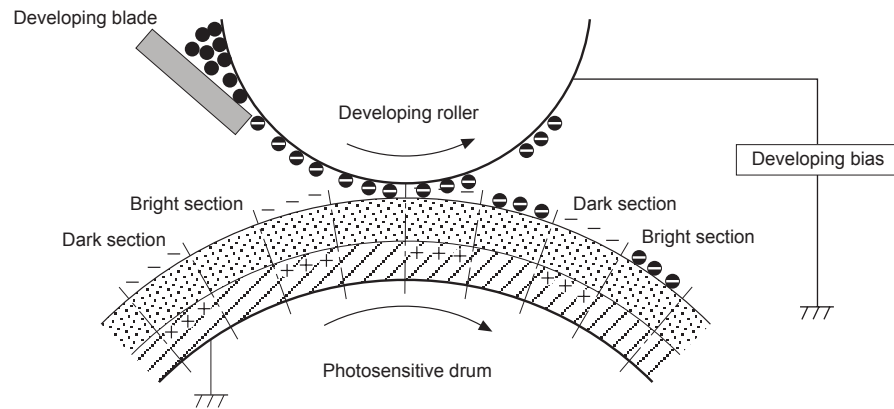

F-2-8

Transfer Block

This block consists of three steps. In this block, the toner image on the surface of the photosensitive drum is transferred onto paper via the ITB.

Step 5: Primary Transfer

The toner on the photosensitive drum is transferred onto the ITB.

A positive DC bias is applied to the primary transfer roller to charge the ITB positively. This step transfers the negative-charged toner on the surface of the photosensitive drum onto the ITB.

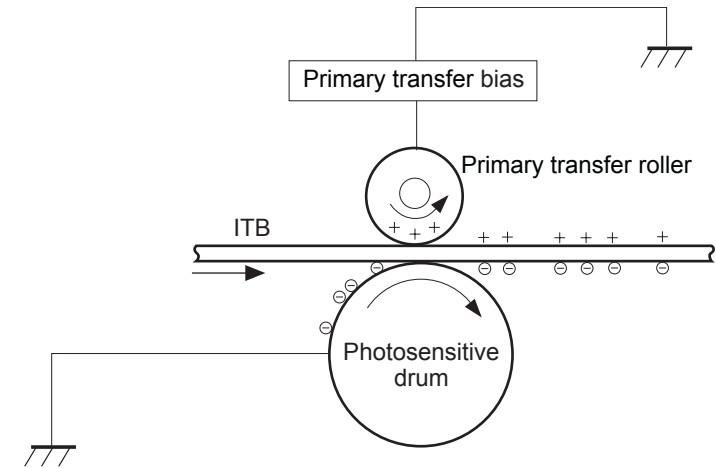

F-2-9

● Step 6: Secondary Transfer

The toner on the ITB is transferred onto paper.

A positive DC bias is applied to the secondary transfer outer roller to charge the paper positively. This step transfers the negative-charged toner on the ITB onto the paper.

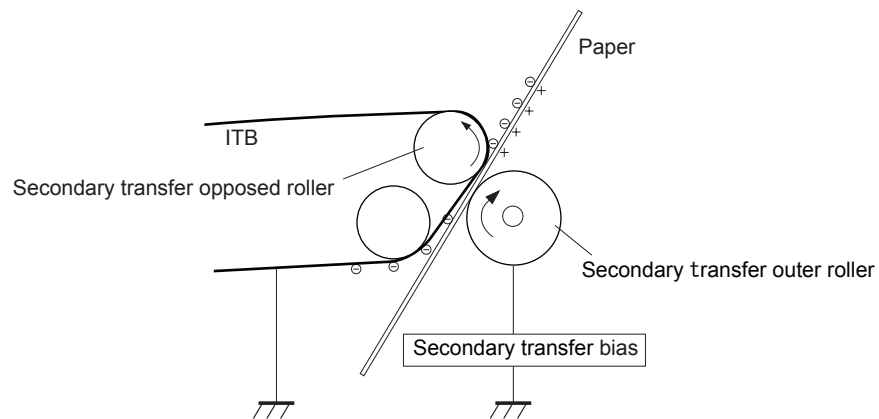

F-2-10

● Step 7: Separation

Elasticity of the paper separates the paper from the ITB (curvature separation). To secure the paper feed system and obtain stable image quality, a static eliminator is provided after the paper is transferred so that the electric charge on the backside of the paper attenuates.

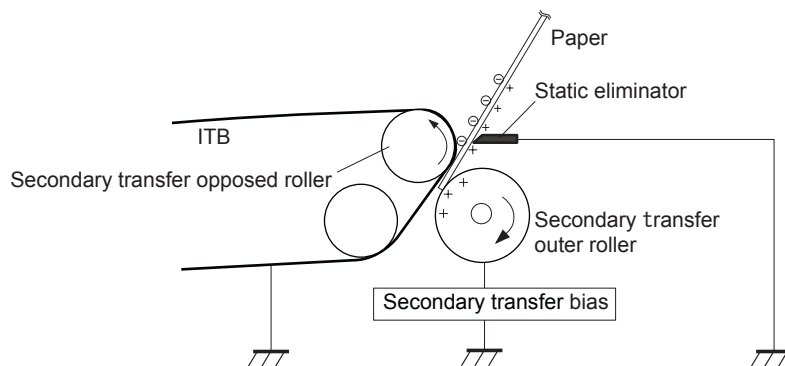

F-2-11

■ Fixing Block

In this block, a toner image is fixed to paper.

● Step 8: Fixing

The on-demand fixing method is used in this fixing assembly.

When pressure and heat are applied to the paper and toner on it, the toner is melt blended with mixed color onto the paper to form a permanent image.

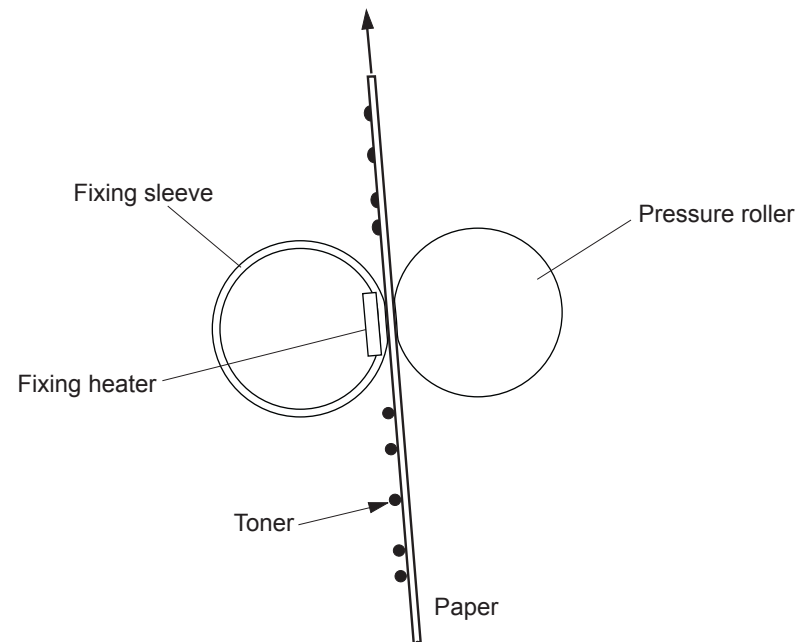

F-2-12

ITB Cleaning Block

In this block, cleaning is performed to remove waste toner on the surface of the ITB.

Step 9: ITB Cleaning

The waste toner on the surface of the ITB is removed by the cleaning blade and collected into the waste toner container by the waste toner feed screw. By this operation, cleaning is performed to the surface of the ITB.

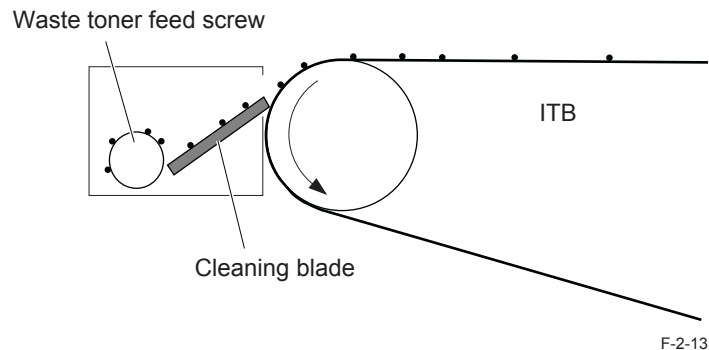

Photosensitive Drum Cleaning Block

In this block, cleaning is performed to remove waste toner on the photosensitive drum.

Step 10: Photosensitive Drum Cleaning

The waste toner on the photosensitive drum is removed by the cleaning blade and collected into the waste toner container. By this operation, cleaning is performed to the surface of the photosensitive drum.

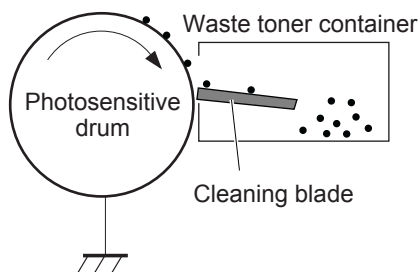

Controls

High-voltage Power Supply Control

Overview

High-voltage power supply control is performed to apply various biases to the following components.

- Primary charging roller, Developing roller: Rollers installed inside of each cartridge
- Primary transfer roller, secondary transfer outer roller

These high-voltage biases are generated when the DC controller controls high-voltage power supply.

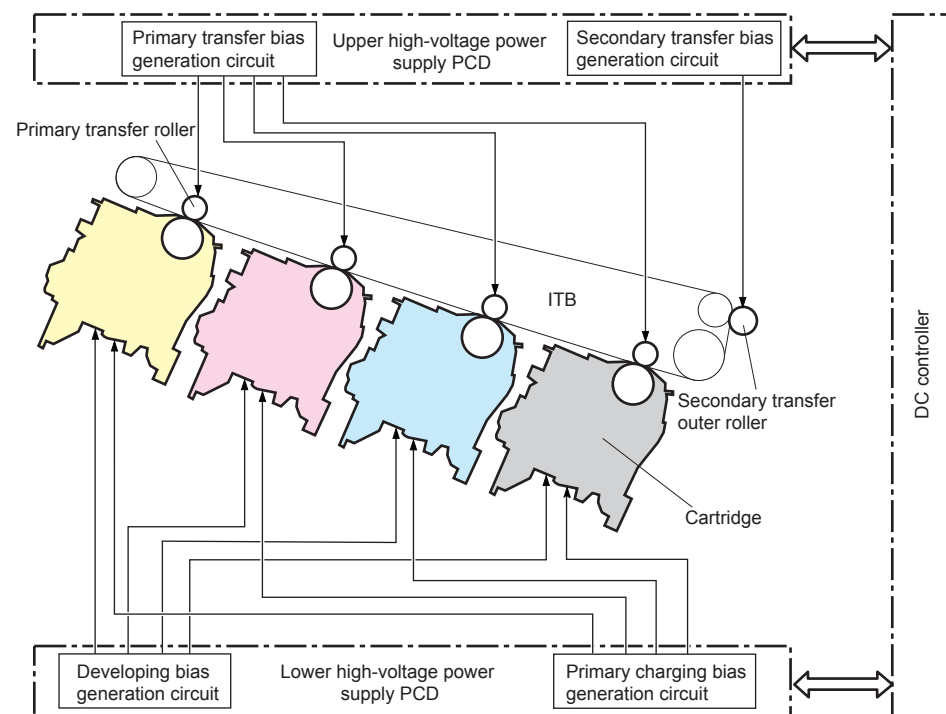

● Generation of a Primary Charging Bias

It is a negative DC bias output to charge the surface of the photosensitive drum with a uniform negative potential as preparation for image formation. It is generated for each color (Y, M, C, Bk) by the primary charging bias generation circuit in lower high-voltage power supply PCD.

● Generation of a Developing Bias

It is a negative DC bias output to make toner adhere to the static latent image formed on the photosensitive drum.

It is generated for each color (Y, M, C, Bk) by the developing bias generation circuit in lower high-voltage power supply PCD.

● Generation of a Primary Transfer Bias

It is a positive DC bias output to transfer toner on the photosensitive drum to the ITB.

It is generated for each color (Y, M, C, Bk) by the primary transfer bias generation circuit in upper high-voltage power supply PCD.

● Generation of a Secondary Transfer Bias

It is a DC bias output to transfer toner on the ITB to the paper.

Both positive (for transfer) and negative (for cleaning) DC biases are generated by the secondary transfer bias generation circuit in upper high-voltage power supply PCD.

■ Calibration

● Overview

Calibration is performed to correct color displacement and density change in an image caused by environmental changes and individual differences among host machines to print a proper image.

The following two controls are performed by calibration.

- Image color displacement volume measurement control
- Image stabilization control

● Image Color Displacement Volume Measurement Control

Overview

This control is performed to correct the volume of color displacement which occurs caused by individual differences among laser scanner units and cartridge units.

The color displacement volume is corrected for the following items by this control.

- Writing position in the main scanning direction
- Magnification in the main scanning direction
- Writing position in the sub scanning direction

The DC controller reads the measurement pattern drawn on the ITB by the color displacement/density sensor and measures the volume of color displacement in the image.

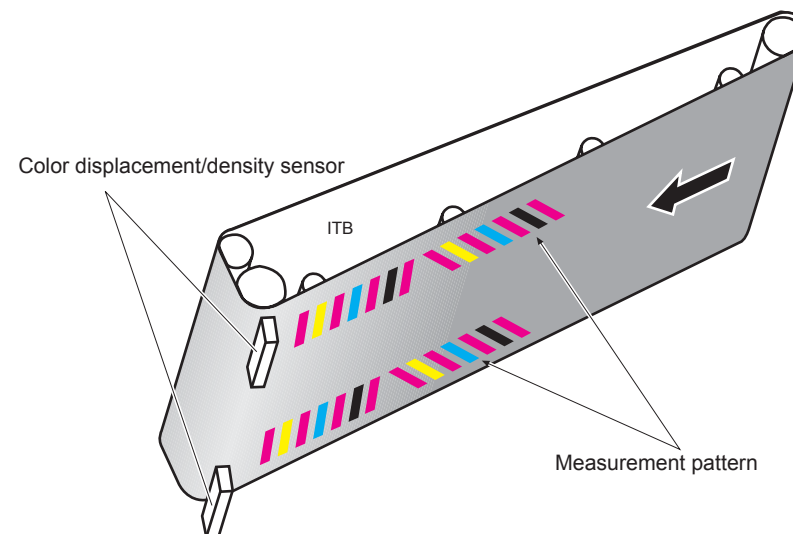

F-2-16

Image color displacement measurement control is performed in the following conditions.

- After the cartridge is replaced
- When the temperature of the sub thermistor is less than 50 degree C at the time when the machine recovered from the sleep status after printing of a specified number of sheets was completed
- When an execution instruction is received from the main controller

If the data obtained by the color displacement/density sensor is out of a specified range when the presence of the cartridge is detected or image color displacement volume measurement control starts, the DC controller judges that a failure occurred in the color displacement/density sensor and reports it to the main controller.

● Image Stabilization Control

Overview

This control is performed to minimize density changes in an image caused by environmental changes or changes in characteristics of the photosensitive drum and toner.

Three controls are performed; environmental correction control, image density correction control (D-max), and image gradation correction control (D-half).

Environmental Correction Control

This control is performed to correct each high-voltage bias to obtain an optimum image according to environmental changes.

The DC controller judges the environment where the printer is currently installed based on the temperature/humidity data received from the environment sensor, and corrects each bias to secure an optimum image.

This control is performed in the following conditions.

- When the power is turned on
- When the cartridge is replaced
- When a significant change was made in the environment

When an error occurred in communication with the environment sensor, the DC controller judges that a failure occurred in the sensor and reports it to the main controller.

Image Density Correction Control (D-max)

This control is performed to stabilize density changes in an image caused by changes in characteristics of the photosensitive drum and toner.

The DC controller corrects each high-voltage bias to obtain appropriate density in the following conditions.

- When the temperature of the sub thermistor is less than a specified temperature at power-on

- When a specified time elapses after printing was completed
- After the cartridge is replaced
- When a specified number of sheets is printed after the cartridge was replaced
- After printing of a specified number of sheets is completed
- When the machine recovers from the sleep status (When a specified time elapses after the machine entered the sleep mode)
- When an execution request was made by the main controller
- When a significant change was made in the environment

Image Gradation Correction Control (D-half)

This control is performed to correct gradation by the main controller.

The DC controller measures a halftone pattern according to the instruction received from the main controller. The main controller corrects gradation based on the measurement result.

This control is performed in the following conditions.

- After D-max is completed
- When an execution request was made by the main controller

If the data obtained by the color displacement/density sensor is out of a specified range when the power is turned on or image color displacement volume control starts, the DC controller judges that a failure occurred in the sensor and reports it to the main controller.

Cartridge

Overview

The cartridge forms a visible image on the photosensitive drum with toner.

Four types of cartridges are installed; yellow, magenta, cyan, and black. All of them have the same structure.

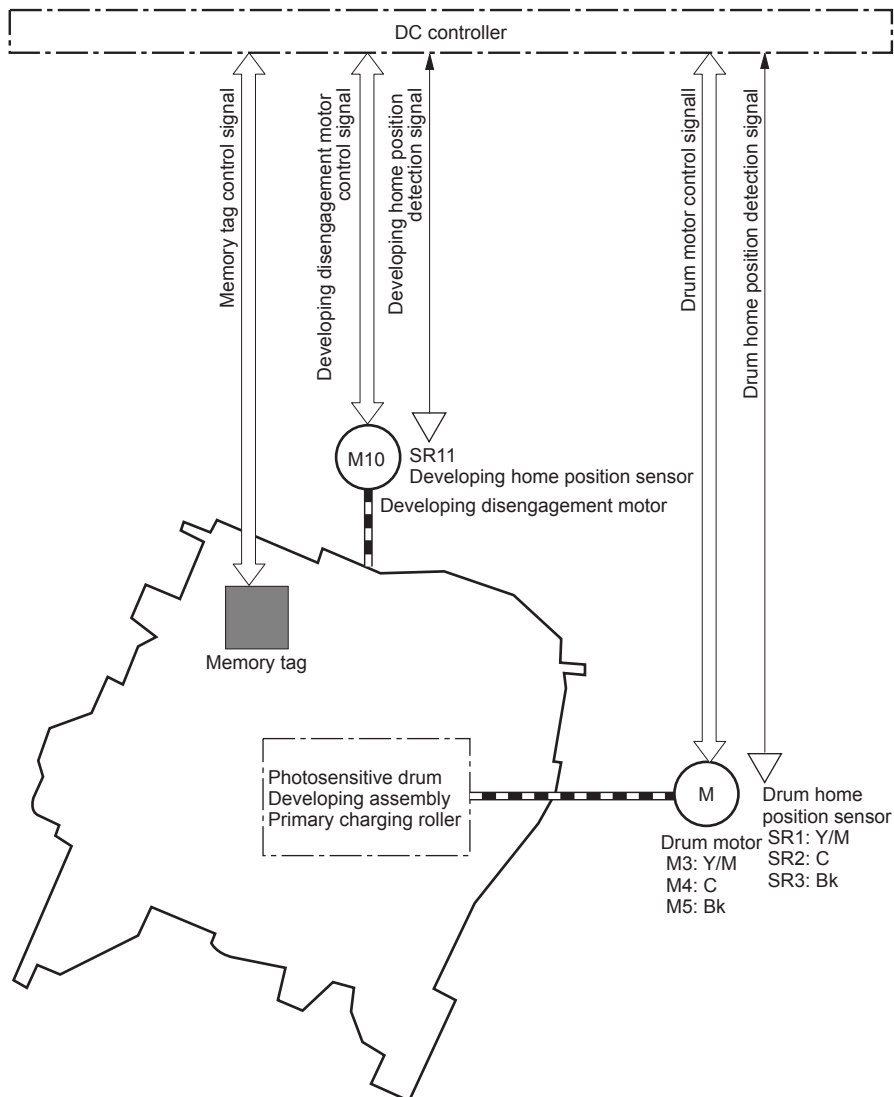

F-2-17

The inside of the cartridge consists of the following components.

- Photosensitive drum
- Developing assembly
- Primary charging roller

The DC controller rotates the drum motor, and drives the photosensitive drum, developing assembly, and primary charging roller.

Memory Tag

A memory tag is a nonvolatile memory.

This machine enables to detect/memorize the use condition of the cartridge, etc., by reading/writing the data stored in the memory tag.

When a failure occurred during reading/writing from the memory tag, the DC controller judges that a memory tag error occurred and reports it to the main controller.

Cartridge Presence Detection

The presence of the cartridge is detected.

It is detected by the color displacement/density sensor.

Timing: power on or a wait period after closing the door.

Method: the color displacement/density sensor detects the toner pattern for detection on ITB.

When the pattern is detected, DC controller judge cartridge existence and reports it to the main controller.

Toner Level Detection

The toner level in the cartridge is detected.

It is detected by the optical detection method.

DC controller detects two toner levels and reports it to the main controller.

- Prepare Toner
- Change Toner

Cartridge Life Detection

Whether the cartridge reached its life or not is detected.

It is detected based on the operation time of the drum and developing unit inside of the cartridge.

When the cartridge reached its life, "Check toner cartridge" is displayed, and machine stops operation. The machine can be used after pressing online key, but image quality is not guaranteed.

Developing Assembly Engagement/Disengagement Control

This control is performed to engage/disengage the necessary developing assembly with/from the photosensitive drum according to the specified print mode (full color/monochrome). This control enables to engage the developing assembly with the photosensitive drum only when needed so that deterioration of the photosensitive drum is prevented to secure the maximum life.

<All developing assemblies are engaged with the photosensitive drums>

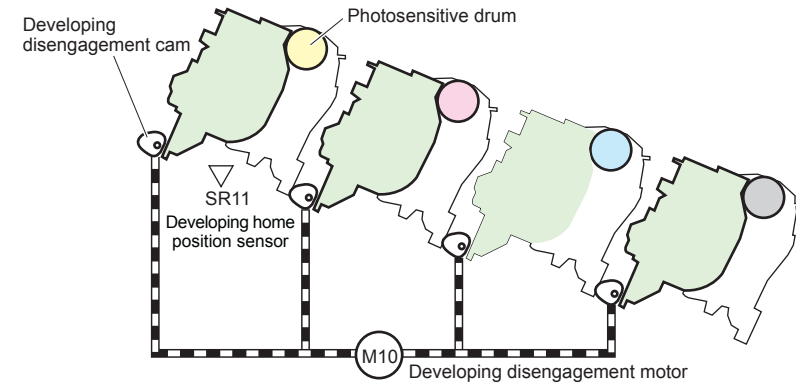

<When only the Bk developing assembly is engaged with the photosensitive drum:>

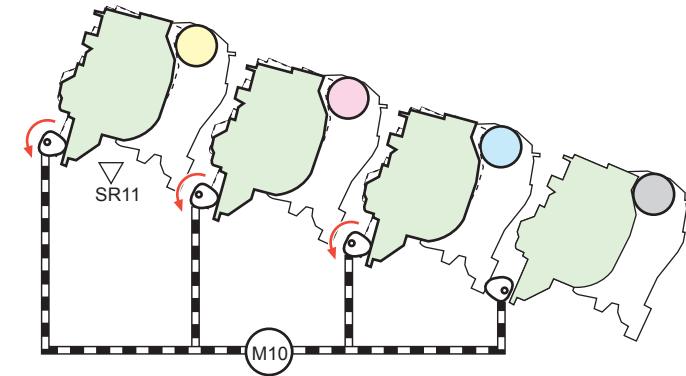

<When all developing assemblies are disengaged from the photosensitive drums>

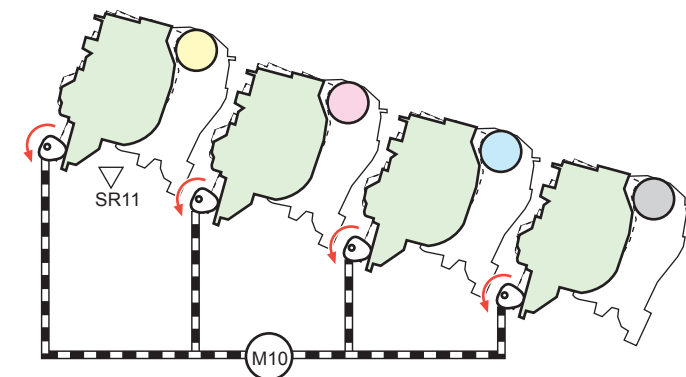

F-2-18

DC controller rotates the developing engagement motor and changes the direction of the engagement/disengagement cam to engage/disengage the developing assembly with/from the photosensitive drum.

The DC controller controls the condition of the developing assembly (engagement or disengagement) based on the volume of rotation of the developing disengagement motor after the output of the developing home position sensor was detected.

During power is off, standby or printing is completed, the developing assembly is disengaged from the photosensitive drum. All developing assemblies are engaged with the photosensitive drums at full-color printing mode (including mixing the monochrome and color printing job), and only the Bk developing assembly is engaged with the photosensitive drum at monochrome printing mode.

When a specified developing home position sensor signal condition cannot be detected during the engagement/disengagement operation of the developing assembly, the DC controller judges that a failure occurred in the developing disengagement motor and reports it to the main controller.

ITB Unit

Overview

The ITB unit primarily transfers the toner image on the photosensitive drum onto the ITB. The inside of the ITB unit consists of the following components.

- ITB
- ITB drive roller
- ITB slave roller
- Primary transfer roller
- ITB cleaner

The ITB drive roller is driven by the drum motor 3 (M5) and rotates the ITB.

The primary transfer roller rotates, driven by the ITB.

The ITB cleaner cleans the surface of the ITB.

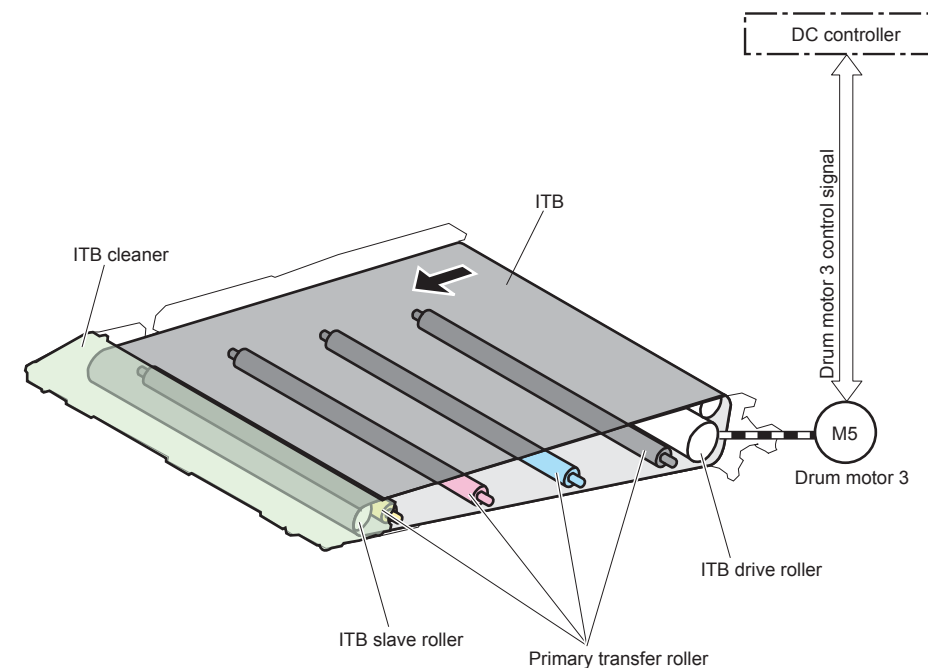

F-2-19

Primary Transfer Roller Engagement/Disengagement Control

This control is performed to engage the ITB with the necessary photosensitive drum according to printing operation. The operation is switched among three conditions according to printing operation.

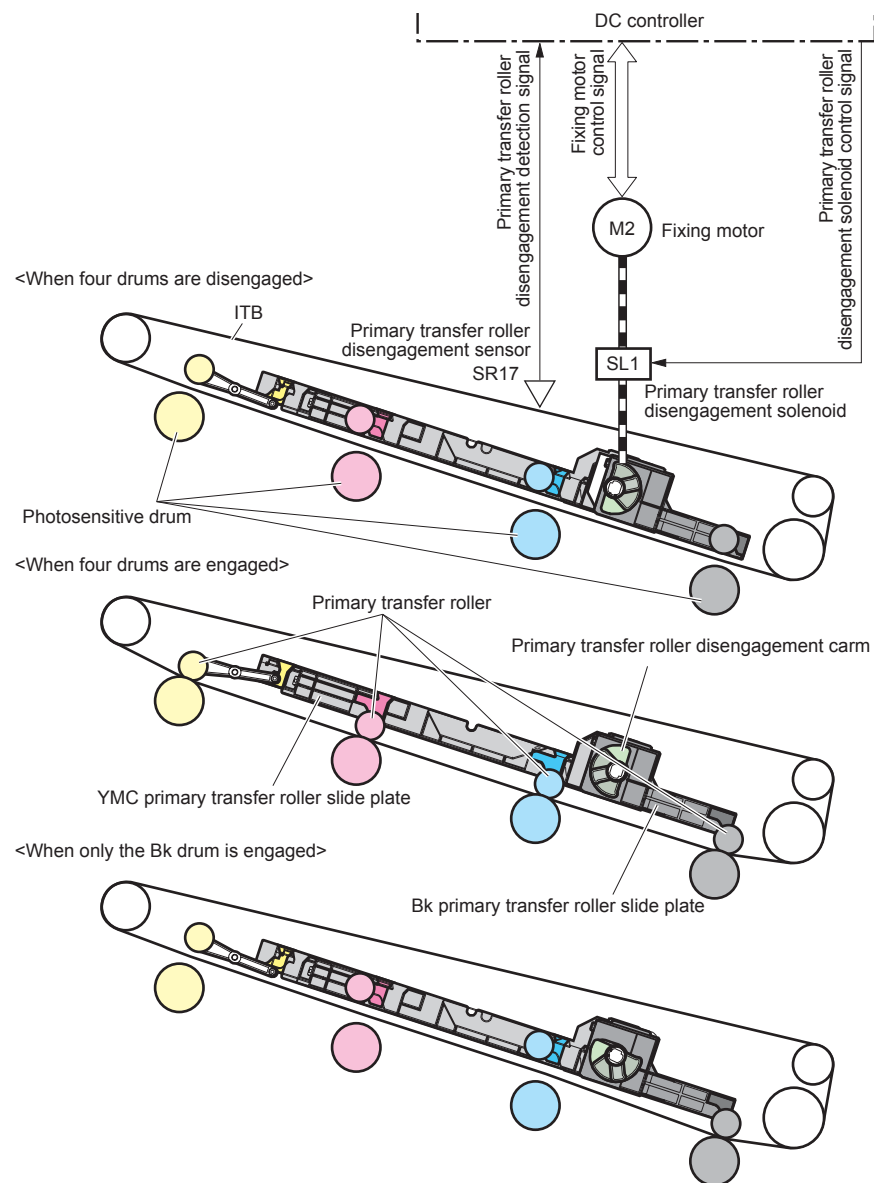

F-2-20

Engagement/disengagement operation of the primary transfer roller is explained below.

The drive force of the fixing motor is sent to the primary transfer roller disengagement cam by the primary transfer roller disengagement solenoid and rotates the cam. The operation of the cam slides the YMC or Bk primary transfer roller slide plate horizontally, and moves the primary transfer roller vertically. When the primary transfer roller moves vertically, the ITB is engaged with or disengaged from the photosensitive drum.

The DC controller moves the primary transfer roller to the home position (the condition where all primary transfer rollers are disengaged) by rotating the fixing motor and turning on the primary transfer roller disengagement solenoid when the power is turned on. When the primary transfer roller disengagement solenoid is turned on for a specified number of times in this condition, the primary transfer roller moves vertically, and the ITB is engaged with or disengaged from the photosensitive drum.

The operation is switched among the following three conditions according to printing operation.

1. All drums are disengaged.

This is a condition at power off or standby. The ITB is disengaged from all photosensitive drums. This condition is a home position of the primary transfer roller.

2. All drums are engaged.

This is a condition at full-color printing (including mixing the monochrome and color printing job). The ITB is engaged with all photosensitive drums.

3. Only the Bk ITB is engaged.

This is a condition at monochrome printing. The ITB is engaged with the Bk photosensitive drum only.

When a specified level of output cannot be obtained from the primary transfer roller disengagement sensor even when the primary transfer roller disengagement solenoid is turned on in order to perform engagement/disengagement operation of the primary transfer roller, the DC controller judges that a failure occurred in the primary transfer disengagement mechanism and reports it to the main controller.

ITB Cleaning Mechanism

Overview

The ITB cleaner cleans the surface of the ITB.

Waste toner on the surface of the ITB is removed by the cleaning blade mounted inside of the cleaner. The waste toner is transported to the waste toner feed unit by the waste toner feed screw mounted inside of the cleaner. The waste toner feed screw is driven by the drum motor 3 (M5).

The waste toner transported to the waste toner feed unit is transported to the waste toner container by the waste toner feed screw. This screw is driven by the waste toner feed motor (M12).

DC controller detects full status of waste toner container in two levels and reports it to the main controller.

- Full alarm: Detection by the waste toner full sensor
- Full: Detection by the counter : about 2100 pages (A4/LTR size) after full alarm is displayed

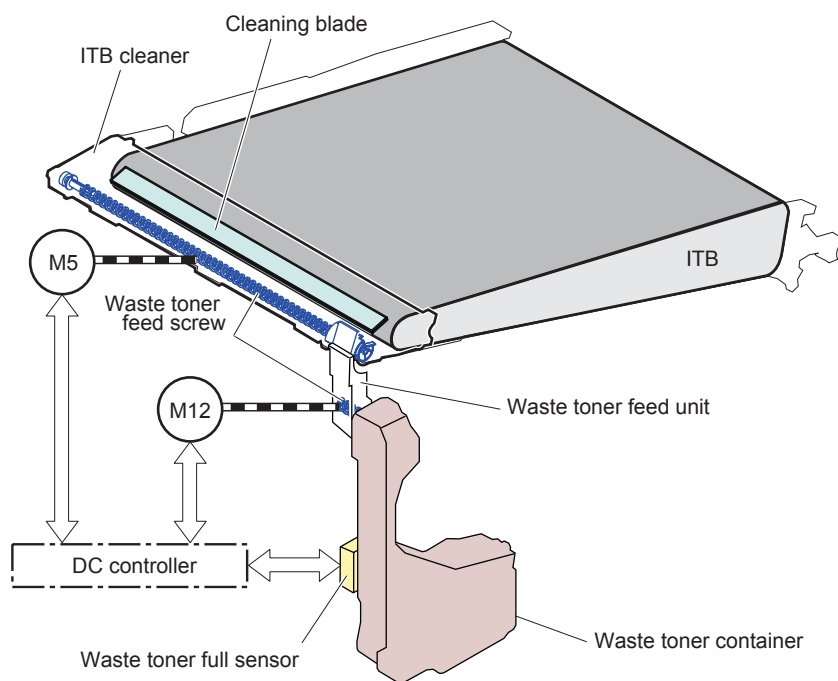

F-2-21

Fixing System

Overview

Fixing control is performed to control the temperature of the fixing assembly. The on-demand fixing method is used in the fixing assembly of this machine.

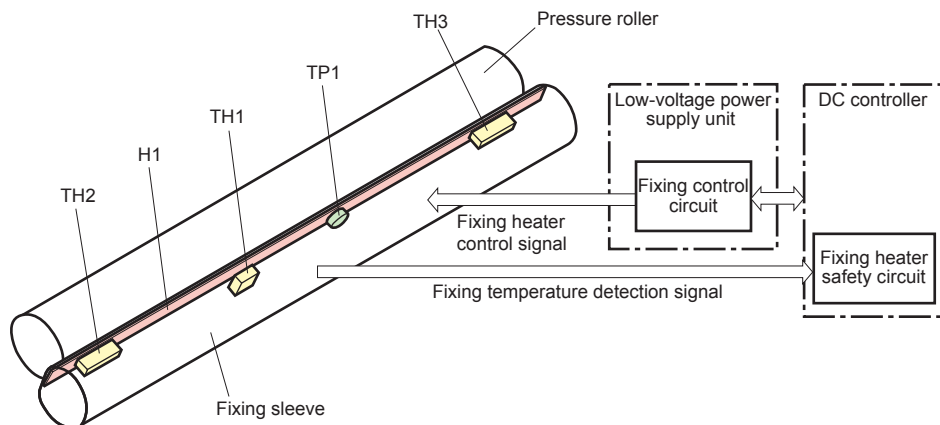

F-2-22

- Fixing heater
Fixing heater (H1): Heats the fixing sleeve
- Thermistor
Main thermistor (TH1): Detects the temperature of the center of the fixing sleeve (Contact type)
Sub thermistor 1 (TH2): Detects the temperature of the edge of the fixing heater (Contact type)
Sub thermistor 2 (TH3): Detects the temperature of the edge of the fixing heater (Contact type)
- Thermo switch
Thermo switch (TP1): For fixing heater (Contact type)

The temperature of the fixing assembly configured with the above-mentioned components is controlled by the fixing control circuit and the fixing heater safety circuit based on an instruction of the DC controller.

Various Controls

Speed Control with Small Size Paper (Throughput Down Control)

This control is the control to prevent the temperature at the edge of Fixing Heater from overheating at continuous printing on the paper with width smaller than A4 size. At continuous printing, if the paper width is shorter than 210mm (A4 size), this control decreases the throughput depending on the number of print by enlarging the pickup interval.

(LBP7750C/LBP5460)

Paper type	Paper size	Print speed(ppm)	
		Cassette pickup/ option cassette pickup	Multi-purpose tray pickup
Plain paper / Plain paper L (60 to 105 g/m ²)	A4	30 (->5.1->3.0)	26.9 (->5.0->3.0)
	A5	31 (->26->21->10->8->5->3.1)	28 (->23->19->10->8->5->3.0)
	B5	31 (->26->21->10->8->5->3.1)	28 (->23->19->10->8->5->3.0)
Heavy paper 1 (100 to 120 g/m ²)	A4	15 (->5.0->3.0)	15 (->5.1->3.0)
	A5	15.8 (->13->10->8->5->4->3.1)	15.7 (->13->10->8->5->4->3.0)
	B5	15.8 (->13->10->8->5->4->3.1)	15.7 (->13->10->8->5->4->3.0)
Heavy paper 2 (115 to 176 g/m ²)	A4	-	9.5 (->5.0->3.0)
	A5	-	10.0 (->8->6->5->4->3.0)
	B5	-	10.0 (->8->6->5->4->3.0)
Postcard		-	10.0 (->8->6->5->4->3.0)

T-2-2

(LBP7780C/LBP5480)

Paper type	Paper size	Print speed(ppm)	
		Cassette pickup/ option cassette pickup	Multi-purpose tray pickup
Plain paper / Plain paper L (60 to 105 g/m ²)	A4	32 (->5.1->3.0)	27 (->5.0->3.0)
	A5	31 (->26->21->10->8->5->3.1)	28 (->23->19->10->8->5->3.0)
	B5	31 (->26->21->10->8->5->3.1)	28 (->23->19->10->8->5->3.0)
Heavy paper 1 (100 to 120 g/m ²)	A4	15 (->5.0->3.0)	15 (->5.1->3.0)
	A5	15.8 (->13->10->8->5->4->3.1)	15.7 (->13->10->8->5->4->3.0)
	B5	15.8 (->13->10->8->5->4->3.1)	15.7 (->13->10->8->5->4->3.0)

Paper type	Paper size	Print speed(ppm)	
		Cassette pickup/ option cassette pickup	Multi-purpose tray pickup
Heavy paper 2 (115 to 176 g/m ²)	A4	-	9.5 (->5.0->3.0)
	A5	-	10.0 (->8->6->5->4->3.0)
	B5	-	10.0 (->8->6->5->4->3.0)
Postcard		-	10.0 (->8->6->5->4->3.0)

T-2-3

Note1: Excluding the pickup retry time.

Note2: This indicates the throughput at clod start in room temperature of 20 deg C (in case that the Fixing Roller edge overheat does not occur.).

MEMO :

- Since the speed is decided depending on the temperature, it may be decreased by skipping 2 or 3 levels unlike one-by-one method.
- Depending on the condition at job start (elapsed time from the previous job or temperature of Fixing Assembly), it may be decreased from the beginning.

Fixing Temperature Control

Overview

Fixing temperature control is performed to keep the temperature of the surface of the fixing sleeve to be the target temperature.

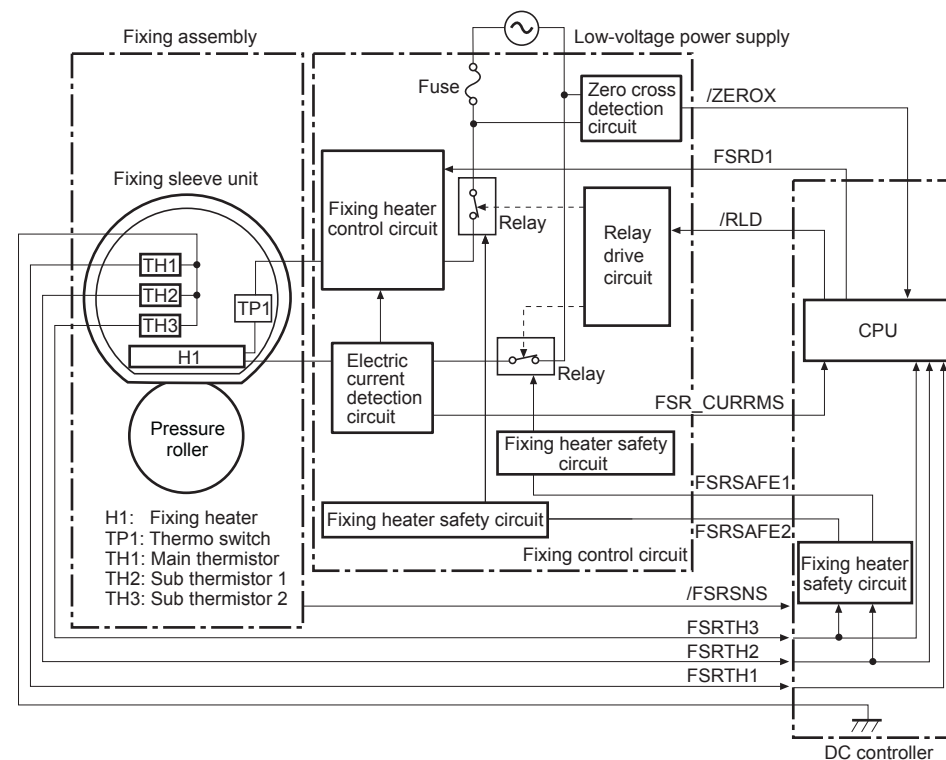

The DC controller detects the temperature of the fixing sleeve in the main thermistor (TH1) at the center, and controls the fixing heater by the fixing heater drive signal (FSRD1) so that the target temperature is kept.

The DC controller also judges the presence of the fixing assembly based on the level of the /FSRSNS signal.

Fixing Target Temperature

Speed	Paper type	Setting on driver	Target temperature (deg C)
1/1 speed	Thin paper (60 to 74 g/m ²)	Plain paper L	172
	Plain paper (70 to 105 g/m ²)	Plain paper	185
1/2 speed	Heavy paper (100 to 120 g/m ²)	Heavy paper 1	165

Speed	Paper type	Setting on driver	Target temperature (deg C)
1/3 speed	Heavy paper (115 to 176 g/m ²)	Heavy paper 2	157

T-2-4

■ Pressure Roller Pressure Release Control

This control is performed to prevent deformation of the fixing sleeve and pressure roller and improve jam removal performance by releasing pressure of the fixing roller at other time than when printing is performed and when the machine is placed in the standby status. When the fixing motor (M2) rotates in reverse, it drives and rotates the fixing pressure release cam. The pressure roller applies or release pressure according to the shape of the cam. The DC controller rotates the fixing motor (M2) in reverse, and controls the pressure application and release condition of the pressure roller based on the signal condition of the fixing pressure release sensor (SR7).

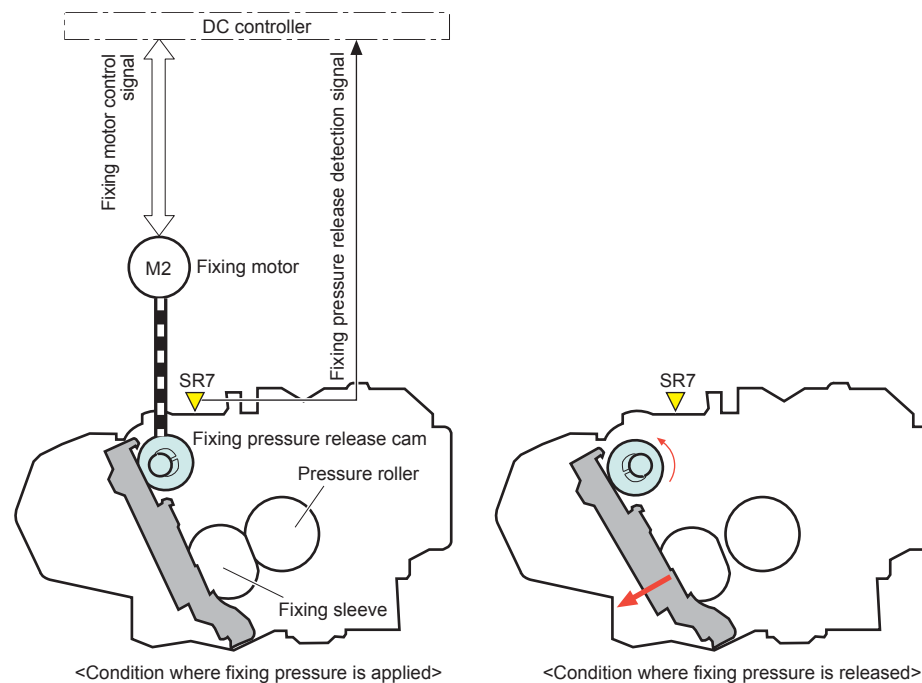

Pressure of the pressure roller is released in the following conditions.

F-2-24

- When the power is turned off
- When the machine enters the sleep status
- When a jam is detected
- When a failure occurs in other mechanism than the pressure release mechanism

The DC controller rotates the fixing motor (M2), and, when no change is made in the condition of the fixing pressure release sensor (SR7) even when a specified time elapses, it judges that a failure occurred in the pressure roller pressure release mechanism and reports it to the main controller.

■ Protection Function

● Overview

This function blocks power distribution to the heater by detecting an abnormal temperature increase in the fixing assembly.

This machine has the four types of protection function listed below to prevent an abnormal temperature increase in the fixing sleeve and pressure roller.

- DC controller
- Fixing heater safety circuit
- Electric current detection circuit
- Thermo switch

The details are explained below.

<DC controller>

The DC controller monitors the temperature of the thermistors (TH2, TH3) mounted at both edges of the fixing heater and that of the main thermistor (TH1) mounted at the center of the fixing sleeve. When the following conditions are detected, the DC controller detects an abnormal high temperature in the fixing heater, stops output of the fixing heater drive signal (FSRD1), turns off the relay, and blocks power distribution to the fixing heater.

Protection function is executed by the DC controller in the following conditions.

TH1: Higher than 230 degree C

TH2: Higher than 285 degree C

TH3: Higher than 285 degree C

<Fixing heater safety circuit>

The fixing heater safety circuits monitors the temperature of the thermistors (TH2, TH3) mounted at both edges of the fixing heater. When the following conditions are detected, the circuit detects an abnormal high temperature in the fixing heater, turns off the relay, and blocks power distribution to the fixing heater.

Protection function is executed by the fixing heater safety circuit in the following conditions.

TH2: Higher than 290 degree C

TH3: Higher than 290 degree C

<Electric current detection circuit>

When the electric current flowing in the fixing heater control circuit exceeds a specified level, the electric current detection circuit stops the fixing heater control circuit and blocks power distribution to the fixing heater.

<Thermo switch>

When the temperature of the fixing heater increased abnormally and the temperature of the thermo switch reached the following condition, the contact point of the thermo switch becomes opened and power distribution to the fixing heater is blocked.

The contact point of the thermo switch becomes opened in the following condition (Note):

TP1: Higher than 270 degree C

Note: The thermo switch is a contact type and mounted in the condition where it is floated over the heater with a floating subpart. Therefore, the thermo switch operates when the floating subpart is melted by heat and the switch comes into contact with the heater. In this condition, the temperature of the surface of the fixing sleeve is approximately 320 degree C.

■ Failure Detection

● Overview

When the following conditions are detected, the DC controller judges that a failure occurred in the fixing assembly, stops output of the fixing heater drive signal (FSRD), turns off the relay, and blocks power distribution to the fixing heater. At the same time, it reports the failure condition to the main controller.

<Abnormal high temperature detection>

When the following conditions are detected, the DC controller judges that an abnormal high temperature occurred regardless of the fixing heater drive condition.

- When the temperature of higher than 230 degree C was detected in the main thermistor (TH1) for a specified time
- When the temperature of higher than 285 degree C was detected in the sub thermistor 1 (TH2) for a specified time
- When the temperature of higher than 285 degree C was detected in the sub thermistor 2 (TH3) for a specified time

<Abnormal low temperature detection>

When the following conditions are detected after each thermistor reached a specified temperature after the power was turned on, the DC controller judges that an abnormal low temperature occurred regardless of the fixing heater drive condition.

- When the temperature of lower than 120 degree C was detected in the main thermistor (TH1) for a specified time
- When the temperature of lower than 100 degree C was detected in the sub thermistor 1 (TH2) for a specified time
- When the temperature of lower than 100 degree C was detected in the sub thermistor 2 (TH3) for a specified time

<Abnormal temperature increase detection>

When the following conditions are detected in each thermistor, the DC controller judges that an abnormal temperature increase occurred.

- When the temperature of the main thermistor (TH1) does not increase by more than 2 degree C within a specified time after the fixing motor was turned on
- When a temperature increase by more than a specified temperature is not detected in each thermistor even when a specified time elapsed after the fixing heater was turned on

<Thermistor open detection>

When the following conditions are detected in each thermistor, the DC controller judges that the thermistor is opened.

- When the temperature of lower than 12 degree C was detected in the main thermistor (TH1) for a specified time after the fixing motor was turned on
- When the temperature of lower than 4 degree C was detected in the sub thermistor 1 (TH2) for a specified time
- When the temperature of lower than 4 degree C was detected in the sub thermistor 2 (TH3) for a specified time

<Drive circuit failure detection>

If a frequency out of a specified level is detected at the time of detection of power frequency when the power is turned on and the machine is placed in the standby status, or if an electric current out of a specified level is detected by the electric current detection circuit, the DC controller judges that a failure occurred in the drive circuit.

<Pressure roller pressure release mechanism failure detection>

See "Pressure Roller Pressure Release Control"(page 2-19). for details.

Pickup Feeding System

Overview

The pickup feeding system feeds and transports paper. The schematic diagram of the sensors is shown below.

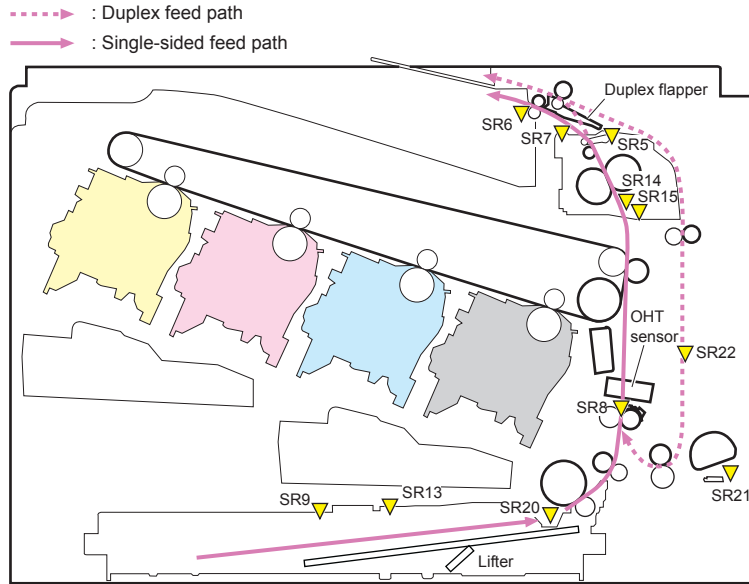

F-2-25

Name	Signal name	Signal name
Fixing delivery sensor	SR5	Fixing delivery detection signal
Delivery tray full level sensor	SR6	Delivery tray full level detection signal
Fixing pressure release sensor	SR7	Fixing pressure release detection signal
TOP sensor	SR8	TOP signal
Cassette media stack surface sensor	SR9	Cassette paper surface detection signal
Cassette presence sensor	SR13	Cassette presence detection signal
Loop sensor 1	SR14	Loop level 1 detection signal
Loop sensor 2	SR15	Loop level 2 detection signal
Cassette media presence sensor	SR20	Cassette media presence detection signal
Multi-purpose tray media presence sensor	SR21	Multi-purpose tray media presence detection signal
Duplex re-pickup sensor	SR22	Duplex re-pickup signal

T-2-5

The schematic diagram of the motors, solenoids, and clutches is shown below.

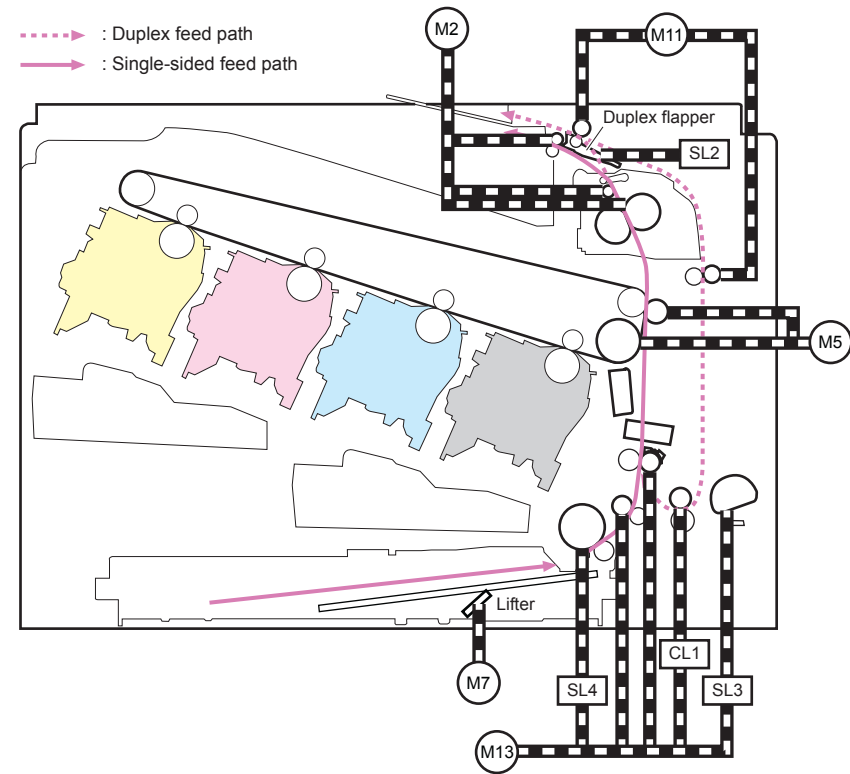

F-2-26

Name	Signal name	Signal name
Fixing motor	M2	Fixing motor control signal
Drum motor 3	M5	Drum motor 3 control signal
Lifter motor	M7	Lifter motor control signal
Duplex reverse motor	M11	Duplex reverse motor control signal
Pickup motor	M13	Pickup motor control signal
Duplex re-pickup clutch	CL1	Duplex re-pickup clutch control signal
Duplex reverse solenoid	SL2	Duplex reverse solenoid control signal
Multi-purpose tray pickup solenoid	SL3	Multi-purpose tray pickup solenoid control signal
Cassette pickup solenoid	SL4	Cassette pickup solenoid control signal

T-2-6

The pickup feeding system is broadly classified into three blocks.

1. Pickup feeding assembly: From each pickup inlet to the fixing assembly inlet
2. Fixing/delivery assembly: From the fixing assembly to the delivery inlet
3. Duplex assembly: From the duplex reverse assembly to the duplex re-pickup assembly

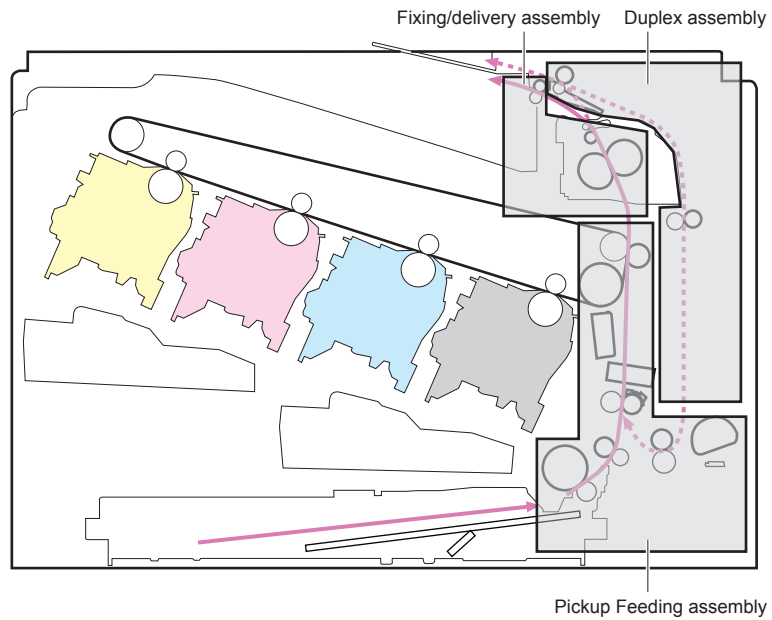

F-2-27

Pickup Feeding Assembly

Overview

The pickup feeding assembly feeds the paper in the cassette or multi-purpose tray into the machine one by one, and transports it to the fixing assembly.

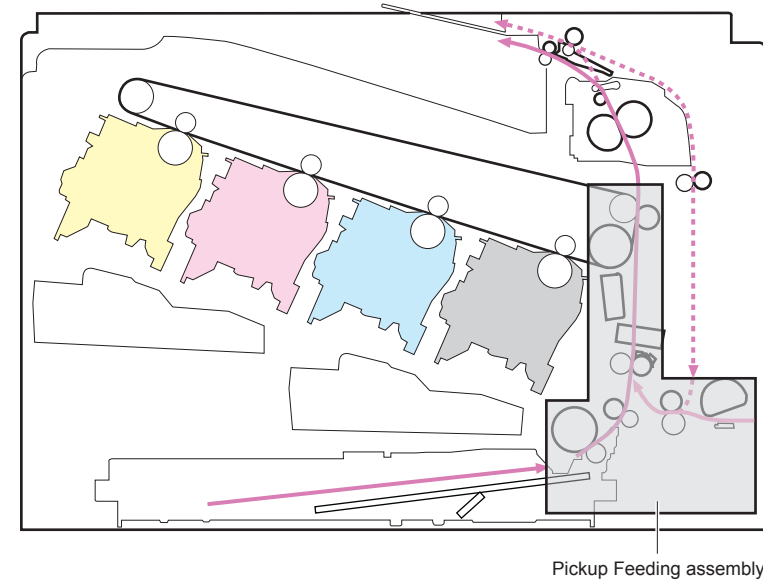

F-2-28

Cassette Pickup

Cassette pickup is performed to feed the paper in the cassette to inside of the machine one by one.

The pickup operation performed by cassette pickup is explained below.

- 1) After the power of the printer is turned on or the cassette is inserted, the lifting plate is lifted up to the position where pickup can be performed, driven by the power of the lifting plate spring and lifting operation.
- 2) When a printing instruction is received from the main controller, the DC controller drives the pickup motor (M13) and drives the cassette pickup solenoid (SL4) at a specified timing. This operation rotates the paper feed roller and picks up the paper in the cassette.
- 3) The double-fed paper is removed by the cassette separation roller, and each sheet is transported into the machine.

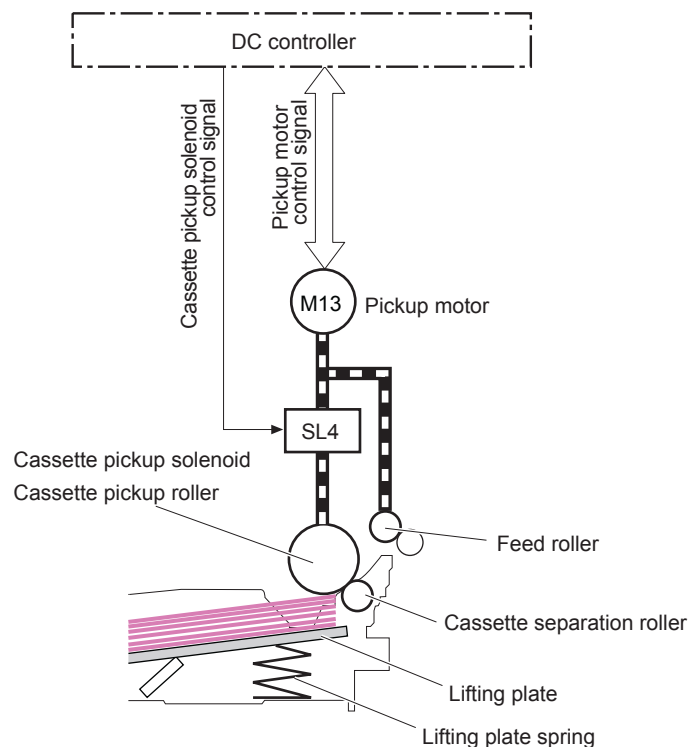

F-2-29

MEMO :

In this machine, lifting operation lifts up the lifting plate to the position where pickup can be performed, and the lifting plate spring is also secondarily used according to the size or stack volume of the paper.

Cassette Presence Detection

Cassette presence detection is performed by the cassette presence sensor.

The cassette presence detection flag is detected by the cassette presence sensor mounted in the lifter drive unit.

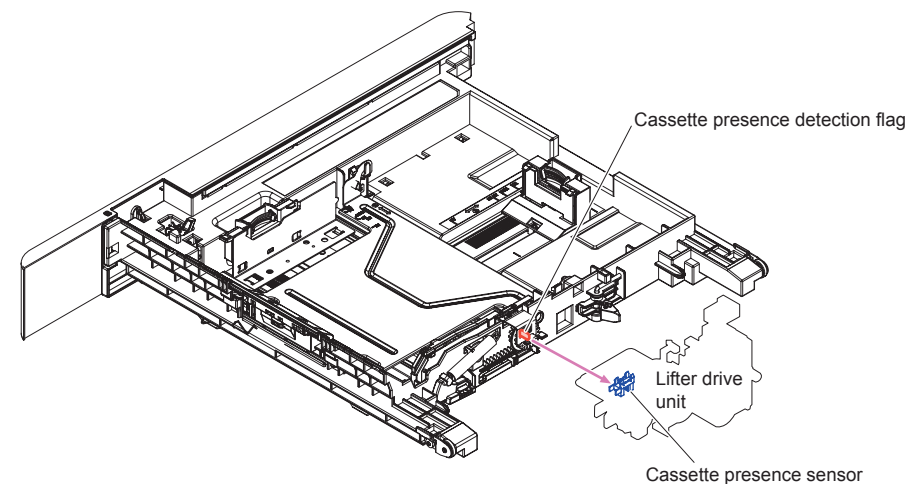

F-2-30

■ Lifting Operation

Lifting operation is classified into the lift-up operation, which lifts up the paper surface to the position where pickup can be performed, and the lift-down operation, which lifts down the lifting plate when non-pickup operation is performed.

The lift-up and lift-down operation is explained below.

● List-up Operation

The DC controller rotates the lifter motor (M7), and moves the lifter rack until it is detected by the cassette media stack surface sensor (SR9). This operation lifts up the lifter and moves the lifting plate to the position where pickup can be performed.

The lift-up operation is performed while the condition of the cassette media stack surface sensor (SR9) is monitored when the power is turned on, the cassette is inserted, or printing is being performed.

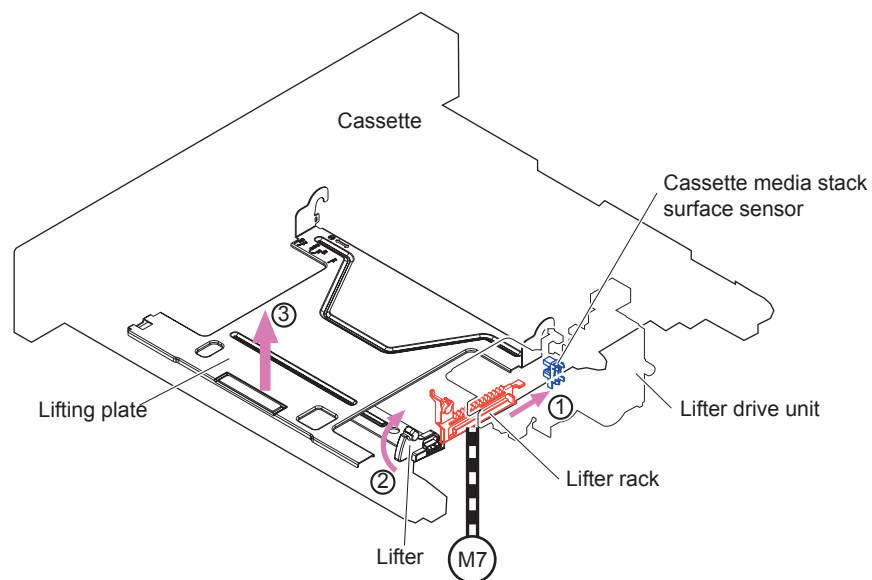

F-2-31

When the paper surface cannot be detected by the cassette media stack surface sensor even when a certain time elapsed after the lift-up operation started, the DC controller judges that a failure occurred in the lift-up mechanism and reports it to the main controller.

● Lift-down Operation

When the lifting plate is placed at the position where pickup can be performed, the paper is pressed to the cassette pickup roller. If the paper is left in the condition for a long time, the paper becomes deformed, causing a failure in pickup operation. Therefore, at other time than when printing is performed, the lifting plate is lifted down so that the paper is disengaged from the cassette pickup roller.

When a print job is not entered even when a specified time elapsed, the DC controller rotates the lifter motor (M7) in reverse and moves the lifter rack to the position where the paper is not detected by the cassette media stack surface sensor (SR9).

■ Cassette Paper Presence Detection

Cassette paper presence is detected by the cassette media presence sensor (SR20).

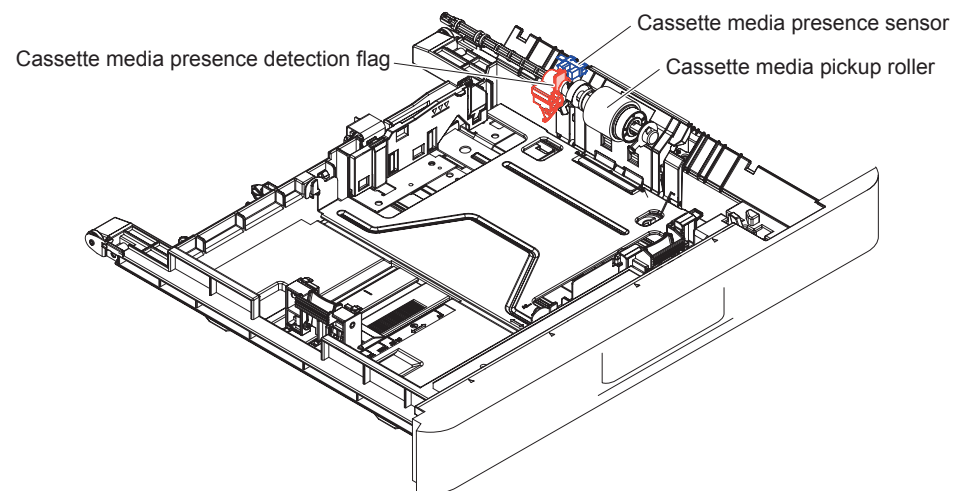

F-2-32

Cassette Double Feeding Prevention Mechanism

In this machine, the separation roller method is used as a mechanism to prevent double feeding when paper is picked up from the cassette.

The separation roller method used in this machine prevents double feeding of paper, using the cassette media separation roller, which does not have drive function. The cassette media separation roller rotates, driven by the cassette media pickup roller.

At Normal Condition

The cassette media separation roller performs slave operation, driven by the cassette media pickup roller via paper. This operation rotates the cassette media separation roller in the feeding direction.

When Double Feeding Occurred

Since the existence of multiple sheets weakens friction between sheets, the drive power of the cassette media pickup roller sent to the cassette media separation roller becomes very weak. The power to control rotation is applied to the cassette media separation roller in this machine, and it is not rotated by the weak drive power sent from the cassette media pickup roller when double feeding occurs. Because of this operation, the separation roller does not rotate, and double-fed paper is not picked up.

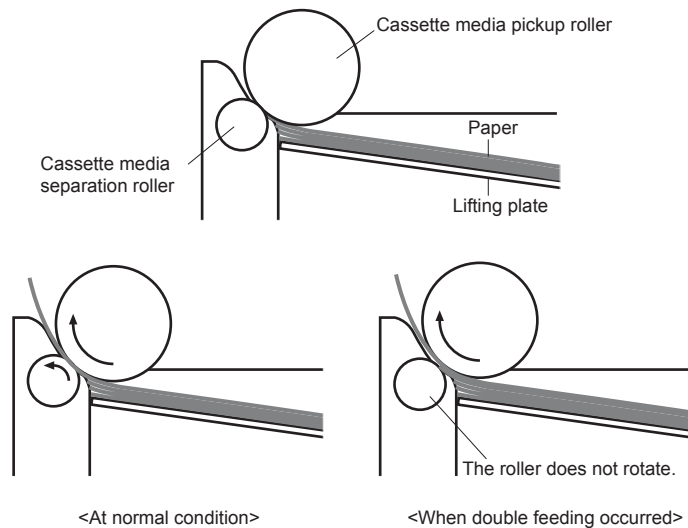

F-2-33

Multi-purpose Tray Pickup

Multi-purpose tray pickup is performed to feed the paper on the multi-purpose tray into the machine one by one.

The multi-purpose tray pickup operation is explained below.

- 1) When a printing instruction command is entered from the main controller, the DC controller rotates the pickup motor (M13) in reverse.
- 2) When the DC controller turns on the multi-purpose tray pickup solenoid (SL3), the multi-purpose tray paper pickup roller rotates and feeds paper.
- 3) The paper is transported into the machine after double-fed paper is removed by the multi-purpose tray media separation pad. Note that the presence of paper is detected by the multi-purpose tray media presence sensor (SL21), and printing is not performed when paper is absent.

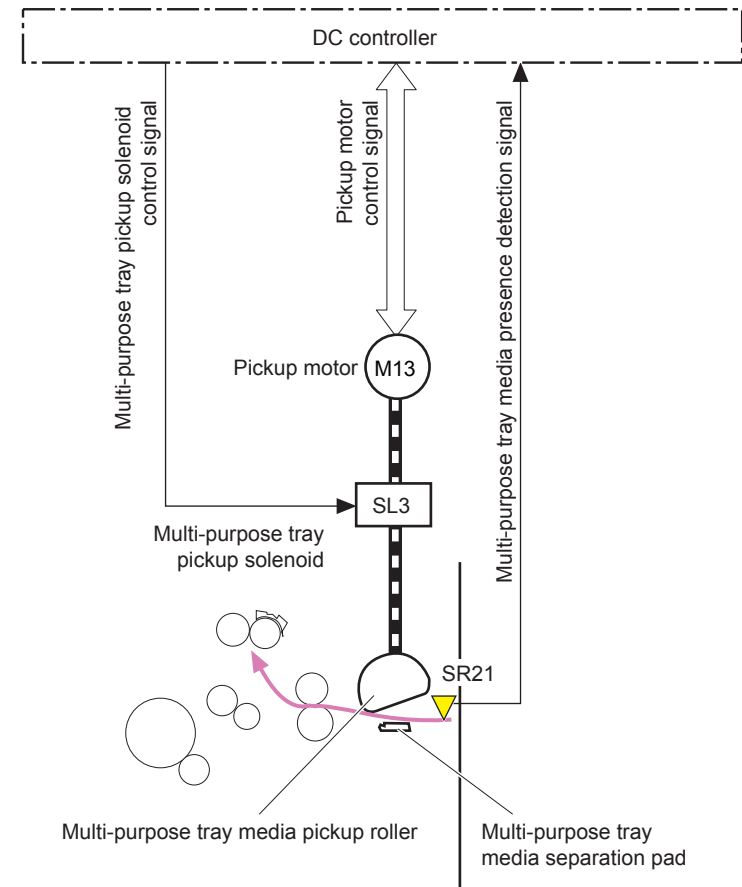

F-2-34

Paper Feed

The paper fed from the cassette or multi-purpose tray is transported to the fixing/delivery assembly.

The DC controller drives the pickup motor (M13) and drum motor 3 (M5), rotates the registration roller, secondary transfer outer roller, and ITB unit to feed the paper.

The paper feed operation is explained below.

- 1) Skew of the paper fed from the cassette or multi-purpose tray is corrected by the registration shutter.
- 2) The DC controller detects the leading edge of the paper by the TOP sensor (SR8), and controls the speed of the pickup motor (M13) to fix the paper position to the leading edge of the toner image on the ITB unit.
- 3) The DC controller detects whether the paper is OHT or not by the OHT sensor.
- 4) Toner is transferred onto the paper from the ITB unit, and the paper is fed to the fixing/feed assembly.

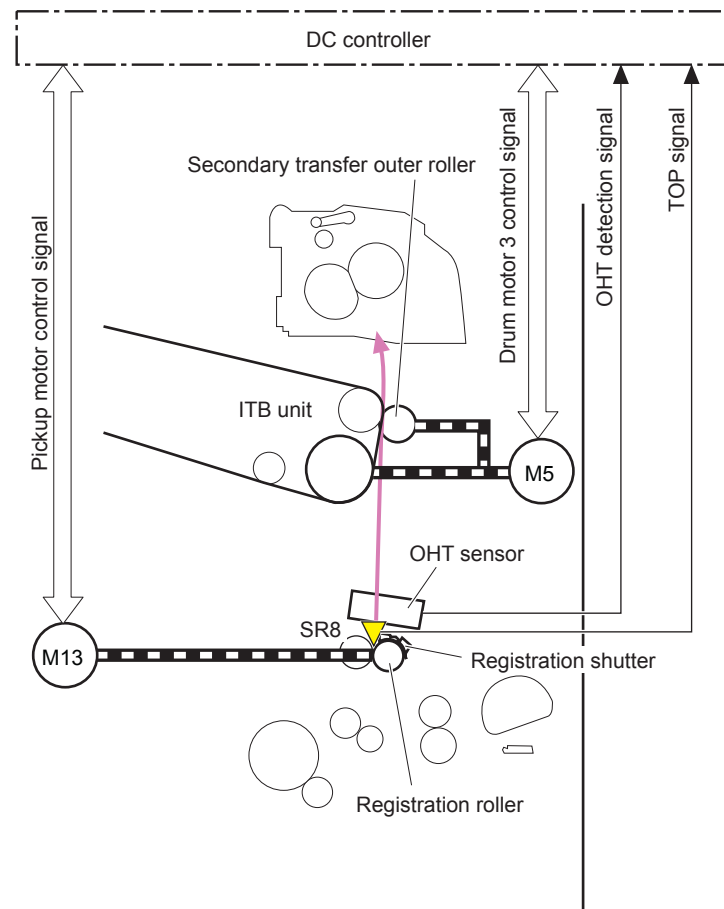

F-2-35

■ Skew Correction Mechanism

In this mechanism, paper skew can be corrected without decreasing throughput.

The operation in the skew correction mechanism is explained below.

- 1) The pickup operation starts, paper is fed, and the leading edge of the paper comes into contact with the registration shutter so that skew of the paper is removed.
- 2) The feed roller keeps pressing the paper in the condition where the paper comes into contact with the registration shutter, and the paper becomes bent.
- 3) When the paper becomes bent, "elasticity" power of the paper lifts up the registration shutter, and the paper passes through the registration shutter. This operation corrects skew in the paper.

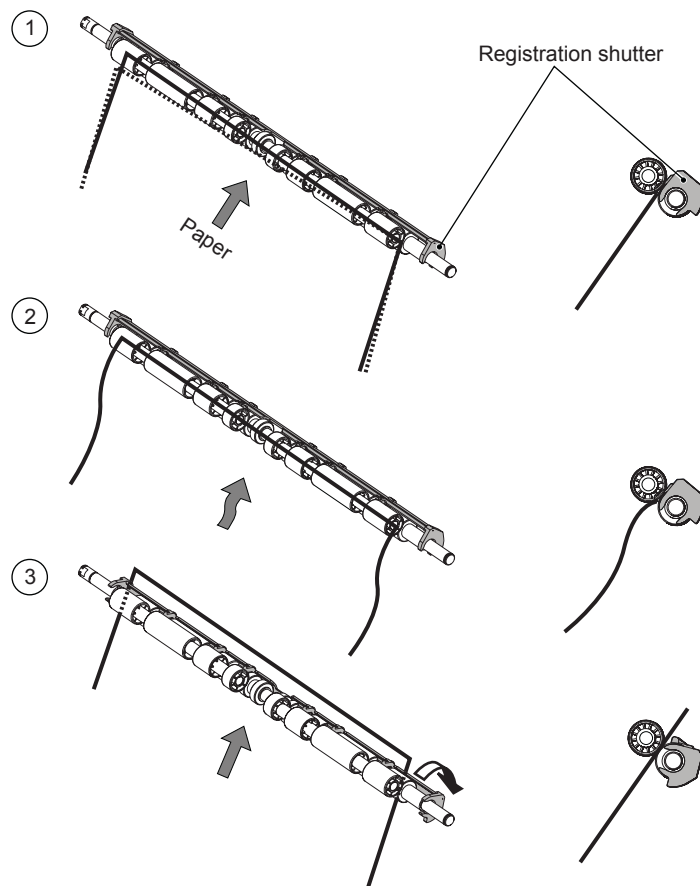

F-2-36

■ OHT Detection Mechanism

Since the printing condition is changed in this machine depending on whether the paper is OHT or not, whether the paper currently transported is OHT or not is detected.

The OHT sensor is a transparent sensor in which an LED is used.

The DC controller reads the paper by the OHT sensor while the paper is transported, and judges whether the paper is OHT or not.

When the paper specified by the main controller is different from the one detected by the OHT sensor, the DC controller judges that a media mismatch error occurred and reports it to the main controller.

The DC controller turns on or off the LED in the OHT sensor when the machine is placed in the wait status or initial rotation status, and, when the obtained light intensity is out of a specified level, it judges that a failure occurred in the OHT sensor and reports it to the main controller.

Fixing/Delivery Assembly

Overview

The fixing/delivery assembly consists of the fixing assembly, which fixes toner on the paper, and the delivery unit, which transports the fixed paper to the delivery tray.

The following controls are performed by the fixing/delivery assembly.

- Control to correct the paper loop volume
- Control to release pressure of the pressure roller

The delivery tray has the delivery tray full level sensor (SR6), which detects the stacking condition of the paper. When this sensor is turned on over a specified time, the DC controller judges that the delivery tray is full and reports it to the main controller.

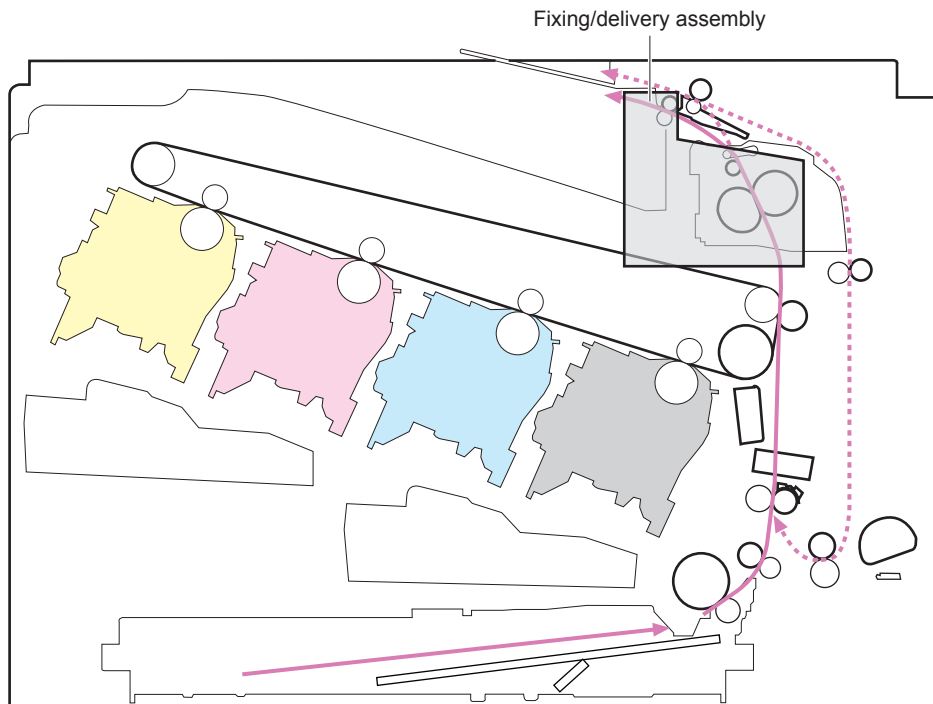

F-2-37

Loop Control

This control is performed to stabilize feeding of paper in front of the fixing assembly.

When the feeding speed of the pressure roller is slower than that of the secondary transfer outer roller, the paper is bent more significantly, and an image failure and paper wrinkle occur. On the other hand, when the feeding speed of the pressure roller is faster than that of the secondary transfer outer roller, the bend in the paper is removed and the paper is pulled out by the pressure roller, which causes a failure of magnification in the sub scanning direction. To prevent this symptom, the loop sensor 1 (SR14) and loop sensor 2 (SR15) are mounted in front of the fixing assembly, and the signal output from the sensors controls the speed of the fixing motor (M2) to keep a proper level of bend in the paper.

The loop sensor 1 is used when thin paper is fed, and the loop sensor 2 is used when thick paper is fed. The sensor flag of the loop sensor 1 has narrow shielding width to support thin paper, and that of the loop sensor 2 has wide shielding width to support thick paper. The DC controller decreases the rotation speed of the fixing motor (M2) when the loop sensor is turned off, and increases the speed when the sensor is turned on.

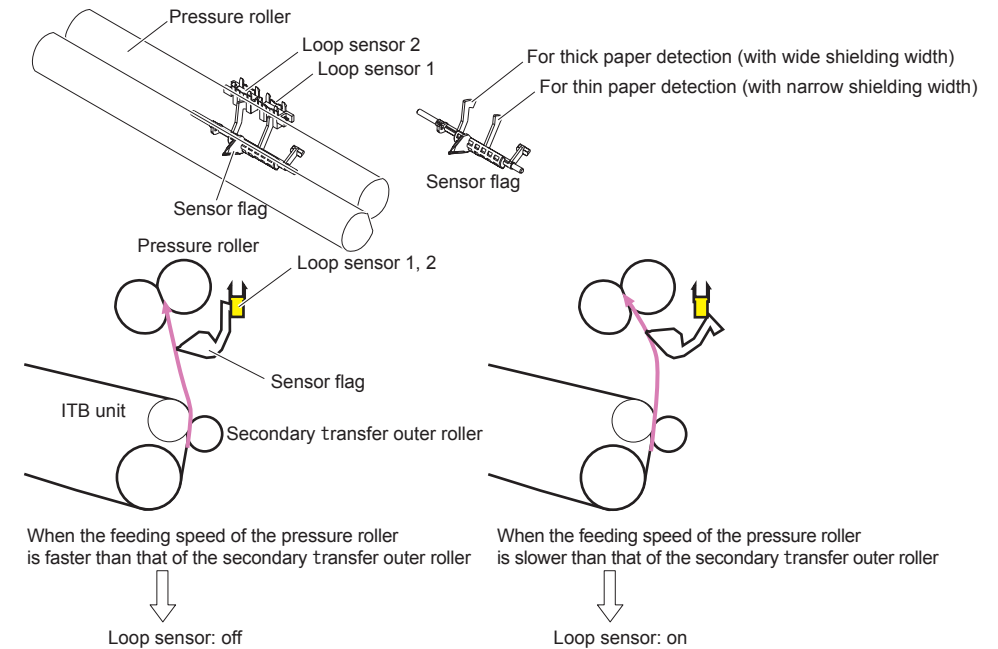

F-2-38

Duplex Assembly

Overview

The duplex reverse assembly is placed at the upper side, and the duplex feed assembly is placed at the right side of the host machine, which reverse/feed paper.

The operation sequence of the duplex unit is controlled by the DC controller. The DC controller drives each load (motors, solenoids, and clutches) according to the control performed by the duplex reverse assembly and feed assembly.

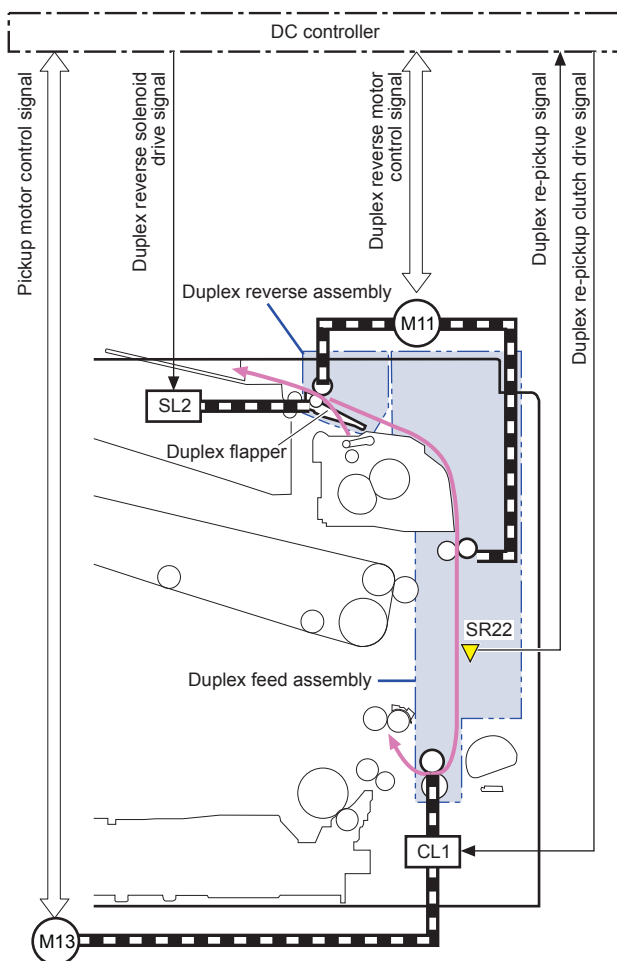

F-2-39

Duplex Reverse/Duplex Feed Control

This control is performed to execute duplex printing by reversing the paper of which the first side printing is completed and feeding it into the printer again.

The reverse operation is performed by control of the duplex reverse motor (M11) and duplex reverse solenoid (SL2) executed by the DC controller.

The duplex feed operation is performed by control of the duplex reverse motor (M11), pickup motor (M13), and duplex re-pickup clutch (CL1) executed by the DC controller.

The duplex feed control sequence is explained below.

- 1) The DC controller turns on the duplex reverse solenoid (SL2) at a specified timing after the first side is printed. This operation moves the duplex flapper to feed the paper to the reverse assembly.
- 2) The DC controller rotates the duplex reverse motor (M11) in reverse at a specified timing after the paper is fed to the reverse assembly. This operation feeds the paper to the duplex feed assembly.
- 3) The DC controller turns off the duplex re-pickup clutch (CL1) and stops the paper at a specified timing after the leading edge of the paper is detected by the duplex re-pickup sensor (SR22). After the specified timing, the DC controller turns on the duplex re-pickup clutch (CL1) and re-picks up the paper.
- 4) The paper is transported to the delivery tray after the back side is printed.

Duplex Pickup Operation

The following two types of duplex printing operation are performed according to the paper size.

- 1) One sheet standby: Duplex printing is performed one by one.
Pickup from multi-purpose tray, legal size from paper feeder
- 2) Two sheets standby: Duplex printing is performed by placing two sheets in standby in the machine. (Up to A4-size is supported.)
Pickup from cassettes in main body, 210.0 mm to 297.0 mm length paper from paper feeder

In the following case, one sheet standby operation is adopted.

- 2 sheets duplex print job
- after changing cassette during job

Duplex printing specification can be made based on an instruction from the main controller.

Jam Detection

Overview

The following paper sensors are provided to detect the presence of paper and whether the paper is correctly fed or not.

- Fixing delivery sensor (SR5)
- TOP sensor (SR8)
- Loop sensor 1 (SR14)
- Loop sensor 2 (SR15)
- Duplex re-pickup sensor (SR22)



F-2-40

Judgment of jam occurrence is made based on whether the paper is placed in the sensor at the timing memorized by the DC controller or not.

When the DC controller judges that a jam occurred, printing operation stops, and the jam occurrence is reported to the main controller. The following types of jams are detected.

Pickup Delay Jam

When Picked Up From The Cassette

The leading edge of the paper cannot be detected by the TOP sensor (SR8) within a specified time after the cassette pickup solenoid (SL4) is turned on.

When Picked Up From The Multi-purpose Tray

The leading edge of the paper cannot be detected by the TOP sensor (SR8) within a specified time after the multi-purpose tray pickup solenoid (SL3) is turned on.

Pickup Stationary Jam

The trailing edge of the paper cannot be detected by the TOP sensor (SR8) even when a specified time elapses after the leading edge of the paper was detected by the TOP sensor (SR8).

Fixing Delivery Delay Jam

The leading edge of the paper cannot be detected by the fixing delivery sensor (SR5) even when a specified time elapses after the leading edge of the paper was detected by the TOP sensor (SR8).

Fixing Delivery Stationary Jam

The trailing edge of the paper cannot be detected by the fixing delivery sensor (SR5) even when a specified time elapses after the leading edge of the paper was detected by the fixing delivery sensor (SR5).

Wrapping Jam

The absence of paper is detected at a timing earlier than that when the trailing edge of the paper is detected by the fixing delivery sensor (SR5) after a specified time when the leading edge of the paper was detected by the fixing delivery sensor (SR5).

■ Residual Paper Jam

The presence of the paper is detected by the following sensors when the machine is turned on or the door is closed.

- Fixing delivery sensor (SR5)
- TOP sensor (SR8)
- Loop sensor 1 (SR14)
- Loop sensor 2 (SR15)

■ Door Open Jam

Opening of the door is detected during paper feed.

● Duplex Re-pickup Assembly Jam 1

The leading edge of the paper cannot be detected by the duplex re-pickup sensor (SR22) even when a specified time elapses after reverse operation of the paper started in the reverse assembly.

● Duplex Re-pickup Assembly Jam 2

The leading edge of the paper cannot be detected by the TOP sensor even when a specified time elapses after re-pickup was performed.

● Automatic Delivery

This function is performed to automatically deliver the deliverable paper remaining in the machine at the initial sequence after the power is turned on or the door is closed.

When the DC controller judges that the paper which can be automatically delivered remains in the machine, it requests automatic delivery to the main controller and stops the printer operation. After that, when it is instructed by the main controller to perform automatic delivery, the DC controller drives the feed system and delivers the paper remaining in the machine to outside of the machine.

Controller System

Overview

The controller system controls all blocks following instructions received from the main controller. The controller system consists of the following components.

- DC controller
- High-voltage power supply PCB(upper/lower)
- Low-voltage power supply
- ALL night power supply(LBP7780C/LBP5480 only)

LBP7750C/LBP5460

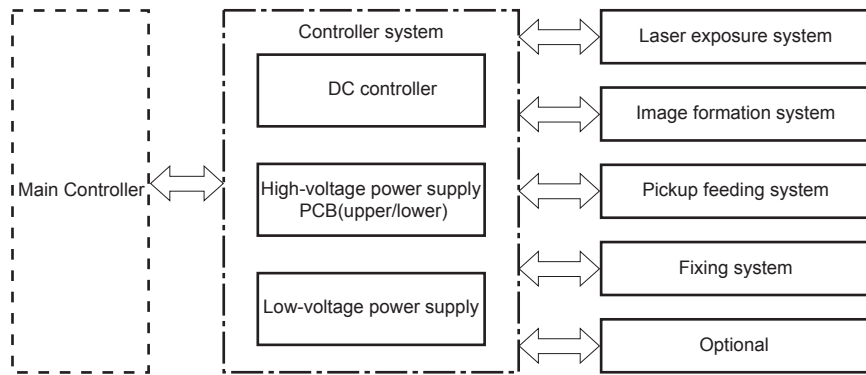

F-2-41

LBP7780C/LBP5480

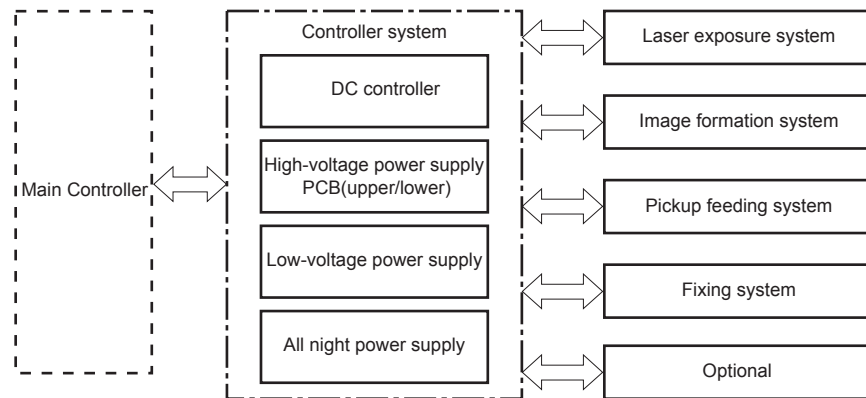

F-2-42

DC Controller PCB

Overview

The DC controller controls the operation sequence in this machine.

LBP7750C/LBP5460

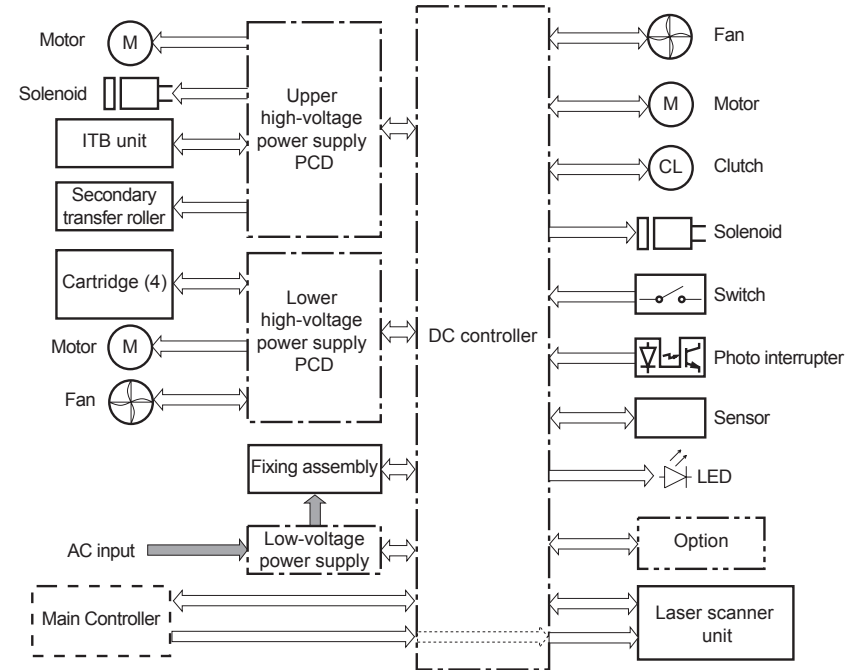

F-2-43

LBP7780C/LBP5480

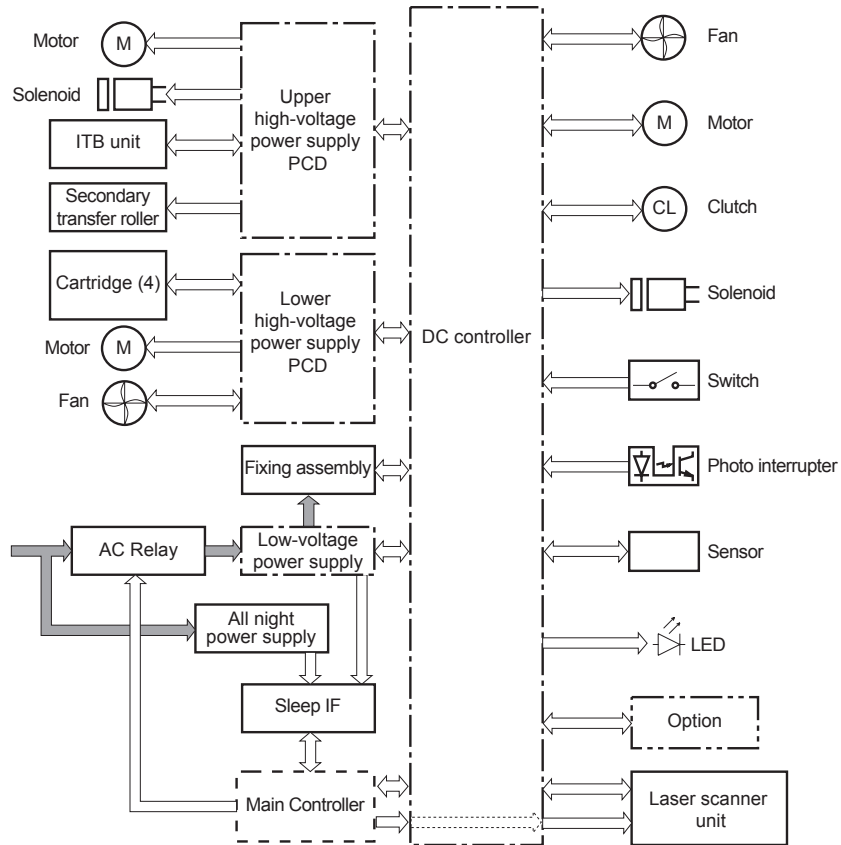

F-2-44

Electrical parts	Electrical symbol	Name	Remarks	
Fan	FM1	Power supply fan		
	FM2	Cartridge fan		
	FM3	Delivery fan		
	FM4	Controller box		
Motor	M2	Fixing motor		
	M3	Drum motor 1		
	M4	Drum motor 2		
	M5	Drum motor 3		
	M7	Lifter motor		
	M8	C/Bk scanner motor		
	M9	Y/M scanner motor		
	M10	Developing disengagement sensor		
	M11	Duplex reverse motor		
	M12	Waste toner feed motor		
	M13	Pickup motor		
	Clutch	CL1	Duplex re-pickup clutch	
	Solenoid	SL1	Primary transfer roller disengagement solenoid	
SL2		Duplex reverse solenoid		
SL3		Multi-purpose tray pickup solenoid		
SL4		Cassette pickup solenoid		
Switch	SW1,SW2	5V interlock switch		
	SW3	24V interlock switch		
	SW4	Power supply switch	LBP7750C LBP5460	
	SW21	Power supply switch	LBP7780C LBP5480	
	-	Test print switch		
LED	LED1 to 4	Front side pre-exposure		
	LED5 to 8	Rear side pre-exposure		

Electrical parts	Electrical symbol	Name	Remarks
Photo interrupter	SR1	Drum home position sensor 1	
	SR2	Drum home position sensor 2	
	SR3	Drum home position sensor 3	
	SR5	Fixing delivery sensor	
	SR6	Delivery tray full level sensor	
	SR7	Fixing pressure release sensor	
	SR8	TOP sensor	
	SR9	Cassette media stack surface sensor	
	SR11	Developing home position sensor	
	SR13	Cassette presence sensor	
	SR14	Loop sensor 1	
	SR15	Loop sensor 2	
	SR17	Primary transfer roller disengagement sensor	
	SR20	Cassette media presence sensor	
	SR21	Multi-purpose tray media presence sensor	
	SR22	Duplex re-pickup sensor	
Sensor	-	OHT sensor (in)	
	-	OHT sensor (out)	
	-	Color displacement/density sensor (front)	
	-	Color displacement/density sensor (rear)	
	-	Environment sensor (temperature/humidity)	
	-	Y toner level sensor	
	-	M toner level sensor	
	-	C toner level sensor	
-	Bk toner level sensor		
-	Waste toner full level sensor		

T-2-7

■ Motor/Fan Control

● Overview

This machine uses 11 motors for paper feed and image formation. It also has four fan motors to prevent a temperature increase in the machine.

● Specifications of Fans

Name		Cooling area	Type	Speed
Power supply fan	FM1	Around the power supply assembly	Air inlet	Full speed / Half speed
Cartridge fan	FM2	Around the cartridge	Air inlet	Full speed / Half speed
Delivery fan	FM3	Around the delivery assembly	Air inlet	Full speed / Half speed
Controller fan	FM4	Controller box	Air inlet	

T-2-8

● Specifications of Motors

Name		Cooling area	Type	Speed
Fixing motor	M2	Pressure roller, Delivery roller, Fixing pressure, Pressure release, Primary transfer roller engagement/disengagement	DC	Provided
Drum motor 1	M3	Photosensitive drum (Y/M), Developing assembly (Y), Primary charging roller (Y/M)	DC	Provided
Drum motor 2	M4	Photosensitive drum (C), Developing assembly (M/C), Primary charging roller (C)	DC	Provided
Drum motor 3	M5	Photosensitive drum (Bk), Developing assembly (Bk), Primary charging roller (Bk), ITB drive roller, Secondary transfer outer roller	DC	Provided
Lifter motor	M7	Lifter of the cassette	DC	Provided
C/Bk scanner motor	M8	Scanner mirror of the C/Bk laser scanner	DC	Provided
Y/M scanner motor	M9	Scanner mirror of the Y/M laser scanner	DC	Provided
Developing disengagement motor	M10	Engagement/disengagement of the developing assembly	SP	Not provided
Duplex reverse motor	M11	Duplex reverse roller, Duplex feed roller	SP	Not provided
Waste toner feed motor	M12	Waste toner feed screw	DC	Provided
Pickup motor	M13	Multi-purpose tray and cassette pickup roller, Feed roller, Registration roller, Re-pickup roller	SP	Not provided

Note: DC; DC motor, SP; Stepping motor.

T-2-9

Failure Detection

Motor Failure Detection

Fixing motor, Drum motor 1 - 3, Scanner motor (Y/M, C/Bk):

When the following conditions are detected, the DC controller judges that a failure occurred in the motor and reports it to the main controller.

- Motor startup failure
The motor speed does not reach a specified level when a specified time elapses after the motor started up.
- Motor rotation failure
The motor speed is out of a specified level continuously over a specified time after the motor speed once reached the specified level.

Lifter motor:

When the cassette media stack surface sensor is not turned on within a specified time after the lifter motor started up, the DC controller judges that a failure occurred in the lift-up mechanism and reports it to the main controller.

Waste toner feed motor:

When an electric current exceeding a certain level flew into the waste toner feed motor, the DC controller judges that a failure occurred in the waste toner feed motor and reports it to the main controller.

Fan Motor Failure Detection

When the fan is locked continuously for a specified time after it started up, the DC controller judges that a failure occurred in the fan and reports it to the main controller.

Low-voltage Power Supply

Overview

The low-voltage power supply converts the AC voltage input from the power supply receptacle into a DC power supply, and supplies it to each load.

LBP7750C/LBP5460

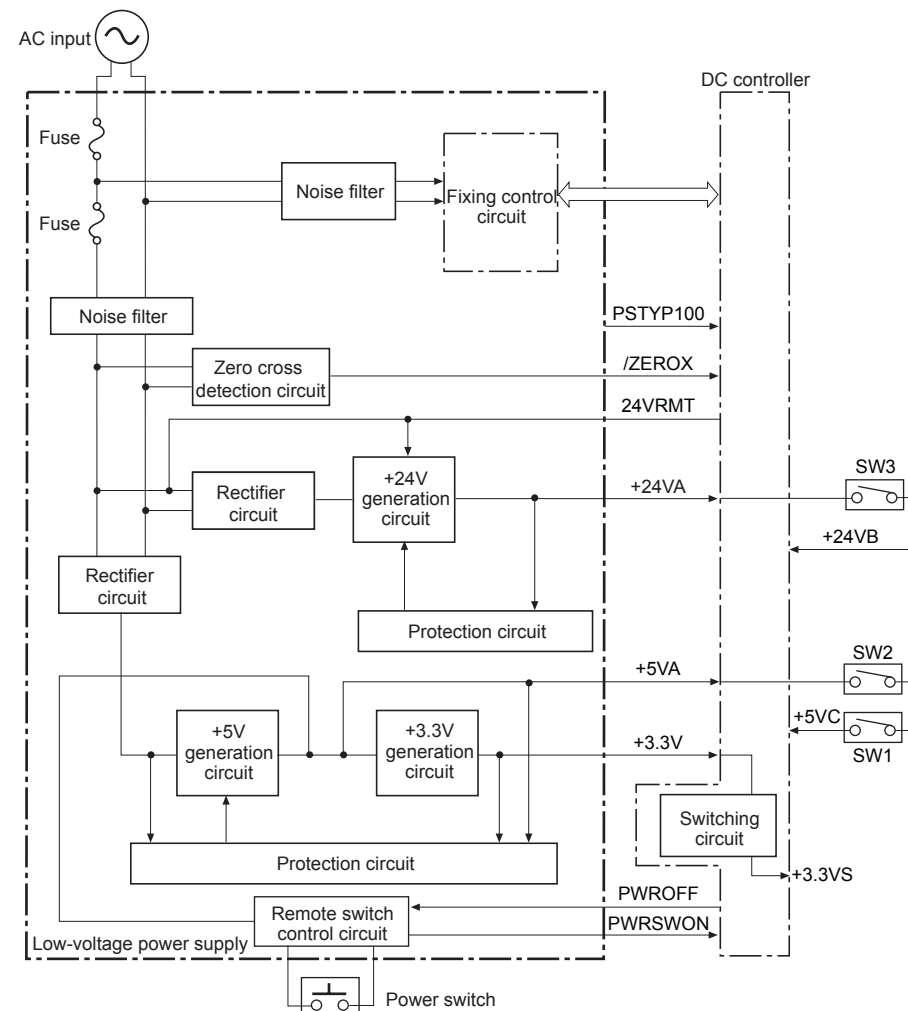

F-2-45

LBP7780C/LBP5480

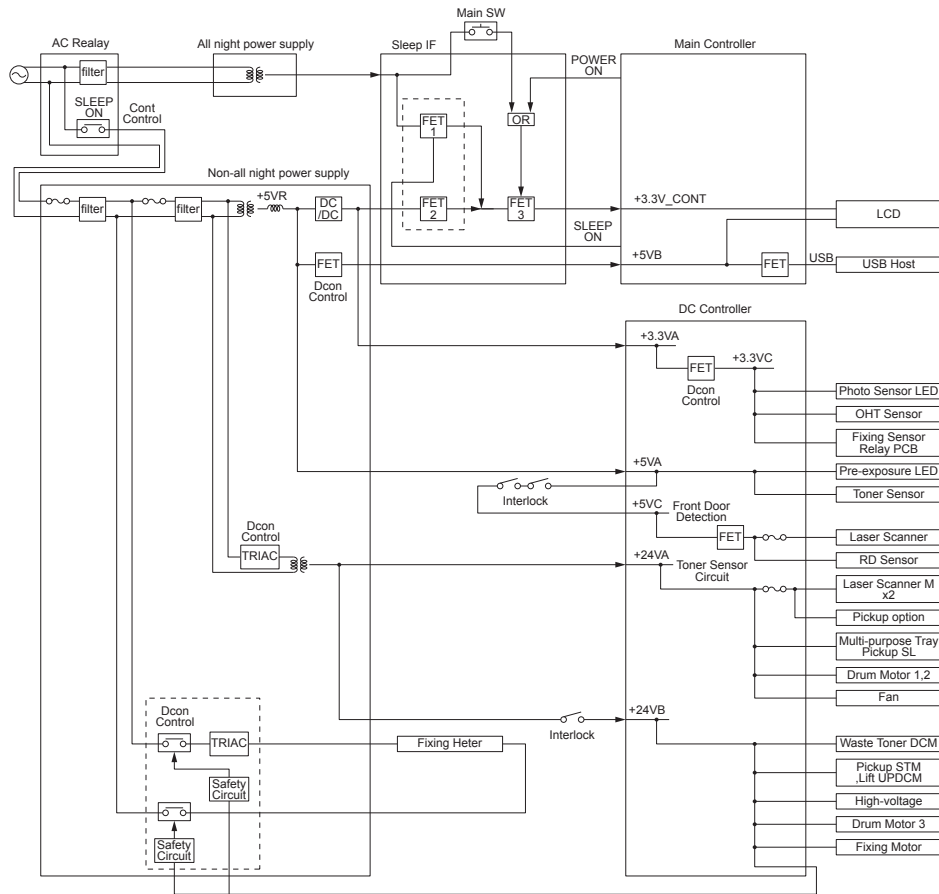

F-2-46

The low-voltage power supply converts the supplied AC power into +24V, +5V, and +3.3V DC power supply, which is needed in the printer host machine.

The +24V DC power supply consists of +24VA, which is supplied by the low-voltage power supply on a constant basis, and +24VB, of which power supply stops when the front door or right door is opened. The +5V DC power supply consists of +5VA, which is supplied by the low-voltage power supply on a constant basis, and +5VC, of which power supply stops when the front door or right door is opened. The +3.3V DC power supply consists of +3.3V, which is supplied by the low-voltage power supply on a constant basis, and +3.3VS, of which power supply stops when the machine enters the sleep status.

■ Protection Function

The low-voltage power supply provides the over-current protection function and the over-voltage protection function, which prevent a failure in the power supply circuit by automatically blocking the output voltage when an excessive electric current flows or an abnormal voltage occurs due to a trouble.

When a DC voltage is not output from the low-voltage power supply, there is a possibility that the protection function has been working. In this case, be sure to turn off the power switch, unplug the power cord from the inlet, remove the trouble in the load, insert the power cord, and then turn on the power switch again.

Power supply fuses are provided immediately after the inlet and in the low-voltage power supply circuit as other protection function.

When an excessive electric current flows into the AC line, the power supply fuse blows and power distribution is blocked.

■ Safety

The function to stop 24VB and 5VC power supply is provided to secure the safety of users and service engineers.

The 24VB power supply, which is provided to the fixing assembly, high-voltage power supply circuit, and motors, stops after the interlock switch is turned off in the following condition.

The 5VC power supply, which is provided to the laser, also stops after the interlock switch is turned off in the following condition.

- When the front door or right door is opened

■ Power Supply Voltage Detection Function

This function detects the voltage of the power supply connected with the printer.

The DC controller detects whether the voltage of the power supply is 100V or 200V based on the output condition of the power supply voltage detection signal (PSTY100), and performs fixing control according to the detection result.

■ Sleep Mode

The sleep mode is provided to save power consumption in the printer. When the machine enters the sleep mode, the DC controller turns off the 24V power supply signal (24VRMT), and stops the +24VA power supply from the 24V generation circuit and +3.3VS power supply from the 3V generation circuit.

(LBP7780C/LBP5480)

Sleep mode is a function to save power consumption of the printer, and the following three types of sleep mode are available.

1. Sleep mode 1: The back light of the Control Panel is turned OFF.
2. Sleep mode 2: The 24V power supply signal (24VRMT) is turned OFF, and +24V power supply from the 24V generation circuit and +3.3V power supply to some of the circuits in the DC Controller are stopped.
3. Sleep mode 3: AC power supply to the main power is stopped, and power is supplied only from the all-night power supply to the controller PCB.

■ Low-voltage Power Supply Failure

When the +24 power is not output from the low-voltage power supply, the DC controller judges that a failure occurred in the low-voltage power supply and reports it to the main controller.

MEAP

Introduction

References by purpose

This chapter describes information for maintenance related to MEAP.

The following table lists references (item names and pages) by purpose.

Purpose	Reference
To install a MEAP application.	Installing an MEAP Application
To start or stop a MEAP application.	Procedure to start and stop a MEAP application
To uninstall a MEAP application.	Procedure to uninstall the MEAP application
To change the method to log in to SMS.	Procedure to manage System Application
To change the password for logging in to SMS.	Changing SMS Login Password
To change the method to log in to the device.	Procedure Changing Login Services
To install a login service for the device.	Procedure Installing Login Services
To check the device's resource information.	Resource Information
To check the device's platform information.	System Information
To check the device's system application information.	MEAP Application Information
To check the contents of the license file.	Check License
To delete the MEAP application's setting information.	MEAP Application Setting Information Management
To download the MEAP application's log information.	MEAP Application Log Management
To check information for using SMS	Preparation for Using SMS
To check the version of MEAP Specifications supported by the device.	MEAP Specifications

T-2-10

About MEAP

Overview

MEAP (Multifunctional Embedded Application Platform) is an application platform (execution platform) that allows the user to execute an application written in the Java language on a Java virtual machine installed on the device.

In this chapter, a device with MEAP is called a device supporting MEAP, and an application which runs on MEAP is called a MEAP application.

MEAP applications are installed on a MEAP device to provide various functions to the device.

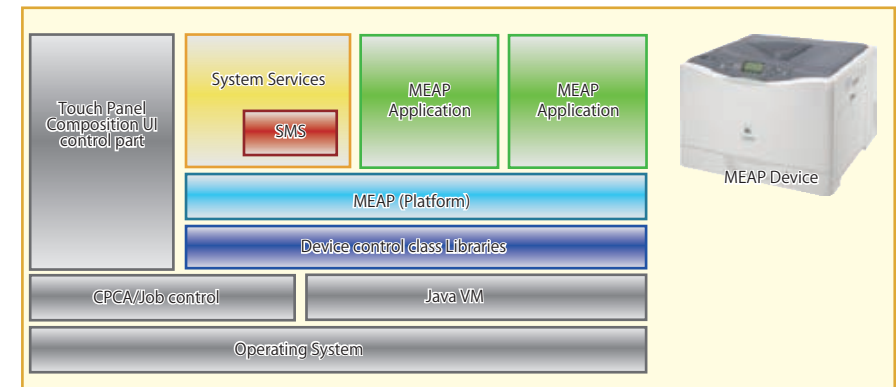

F-2-47

About SMS

Overview

MEAP has SMS (Service Management Service) as a service for managing login services and MEAP applications.

SMS is a servlet-type service which is used via a PC's browser.



F-2-48

Example of the SMS screen

Service Management Service

Device Serial Number: AAAA000000

MEAP Application Management

Application Name	Installed on	Status	License
SampleApp_A	4.4.0 03/08 2012	Installed	Installed
SampleApp_B	4.4.0 03/08 2012	Installed	Installed
SampleApp_C	4.4.0 03/08 2012	Installed	Installed

Resource Information

Resource Name	Amount Used	Remaining	Percent Used
Storage	12505 KB	20263 KB	38%
Memory	1050 KB	19430 KB	5%
Threads	5	123	4%
Sockets	0	128	0%
File Descriptors	4	124	3%

Copyright CANON INC. 2012 All Rights Reserved

F-2-49

About the MEAP Application Management Screen

This screen is used to perform basic management of MEAP applications. Its main functions are listed below.

- Start and stop a MEAP application.
- Uninstall a MEAP application.
- Disable or delete a license file.
- Check the MEAP application information.
- Check the resource information.

Example of the MEAP application management screen

Service Management Service

MEAP Application Management

Application Name	Installed on	Status	License
SampleApp_A	4.4.0 03/08 2012	Installed	Installed
SampleApp_B	4.4.0 03/08 2012	Installed	Installed
SampleApp_C	4.4.0 03/08 2012	Installed	Installed

Resource Information

Resource Name	Amount Used	Remaining	Percent Used
Storage	12505 KB	20263 KB	38%
Memory	1050 KB	19430 KB	5%
Threads	5	123	4%
Sockets	0	128	0%
File Descriptors	4	124	3%

Copyright CANON INC. 2012 All Rights Reserved

F-2-50

For details of this function, see "MEAP Application Management" in this chapter.

About the MEAP Application Installation Screen

It is used to install a MEAP application and license. Its main functions are listed below.

- Install a MEAP application and license file.

Example of the MEAP application installation screen

Service Management Service

Install MEAP Application/License

Application File Path:

License File Path:

F-2-51

For details of this function, see "Installing an MEAP Application" in this chapter.

About System Management

It is used to perform MEAP management other than management of MEAP applications and installation of MEAP applications. Its main functions are listed below.

- Enhanced System Application Management
- System Application Management
- System Information
- MEAP Application Information
- Check License
- Change Password (Change SMS login password)
- MEAP Application Setting Information Management
- MEAP Application Log Management

Example of the system management screen

The screenshot displays the Service Management Service interface. The top bar shows the device ID 'LBP7780C / LBP7780C /' and options for 'To Remote UI' and 'Log Out from SMS'. The main content area is divided into two sections: 'MEAP Application Management' and 'Resource Information'.

MEAP Application Management

Application Name	Version	Installed on	Status	Start	Uninstall	License
SampleApp_A	4.4.0	03/08 2012	Installed	Start	Uninstall	Installed
SampleApp_B	4.4.0	03/08 2012	Installed	Start	Uninstall	Installed
SampleApp_C	4.4.0	03/08 2012	Installed	Start	Uninstall	Installed

Resource Information

Resource Name	Amount Used	Remaining	Percent Used
Storage	12505 KB	20263 KB	38%
Memory	1050 KB	19430 KB	5%
Threads	5	123	4%
Sockets	0	128	0%
File Descriptors	4	124	3%

The interface also includes a sidebar menu with options like 'System Management', 'MEAP Application Management', and 'Resource Information'. The 'System Management' section is highlighted with an orange box in the screenshot.

F-2-52

Preparation for Using SMS

To use SMS, you need to set up network settings for the PC, browser, and devices that are used to access SMS.

Preparation of PC for Accessing SMS

Checking of operation environment

The PC and browser used to access SMS require the following system environment.

Operating System	Supported browser
Windows XP Professional	Microsoft Internet Explorer 6 SP1 or later
Windows Vista SP2	Windows Internet Explorer 8
Windows 7	Windows Internet Explorer 8
Mac OS X 10.3	Safari 1.3.2
Mac OS X 10.4	Safari 2.0.4
Mac OS X 10.5	Safari 3.1.2
Mac OS X 10.6	Safari 4.0.3

T-2-11

PC and browser settings

The PC and browser used to access SMS must meet the following conditions.

- Session cookie is enabled.
- Java Script is enabled.

Device Settings

Network configuration (Activate Network Settings)

To support a MEAP-enabled iR device via network (SMS, etc.), set up the network setting on the touch panel of the iR device (this setting is [ON] by default).

1) Press [Setup] button, select [Network] > [Control Menu] > [HTTP] and select [On].

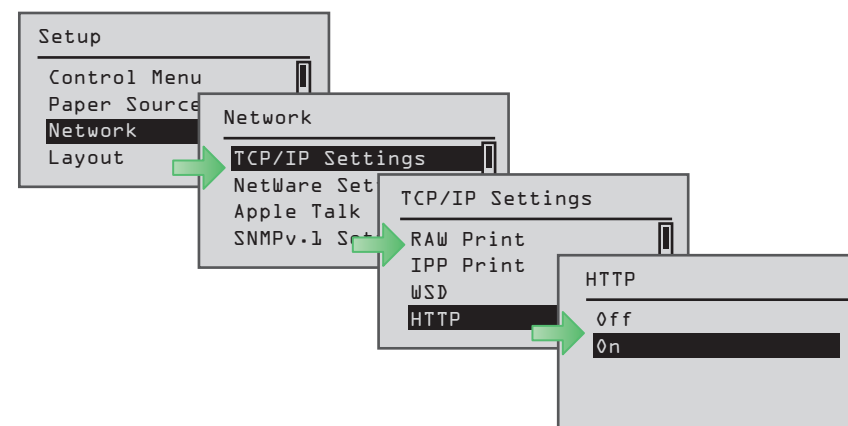

F-2-53

2) Select [On], and then press [OK] on the Control Panel.

3) Restart the machine.

CAUTION:

- The setting [Use HTTP] is not actually enabled/disabled until you have restarted the device.
- You cannot make a connection through a proxy server. If a proxy server is in use, enter the IP address of the MEAP device in the Exceptions field for the browser. Open Internet Options dialog of Internet Explorer and select Connections tab, LAN Settings button, Use a proxy server option, and Advanced button of Proxy server group. Proxy Settings dialog will open. The Exceptions field is in the dialog. As network settings vary among environments, consult the network administrator.
- If Cookie and JavaScript are not enabled in the Web browser, you will not be able to use SMS.

● Key Pair and Server Certificate when Using Encrypted SSL Communication

To use SMS via SSL connection, it is required to specify a key pair and server certificate as the key to be used.

Since a key (default key) that can be used for encrypted SSL communication is installed as standard on the device, advance setting of the key pair and server certificate is not required. In order to use an encryption key other than the default key, follow the procedure "Generating a key pair" shown below to make settings for the key pair and server certificate necessary for encrypted SSL communication.

Note:

- The states of the SSL encryption key and the server certificate can be changed back to the states at the time of shipment by executing CA-KEY clear in service mode level 2 ([COPIER] > [Function] > [CLEAR] > [CA-KEY]). Please note that the encryption keys created by the user and the server certificates added by the user are deleted when CA-KEY clear is executed.
- For detailed procedures of the Default Key setting, refer to [e-Manual > Security].
- As for SMS, by setting a Default Key, encrypted SSL communication is always executed regardless of the following setting: [Settings/Registration] > [Management Settings] (Settings/Registration) > [MEAP Settings] > [SSL Settings]: ON/OFF.

Generating a key pair

1) From a PC on the same network as the device, use a web browser to access the remote UI's portal page. Then, select [Settings/Registration] from the menu on the right side of the screen.

URL to access: `http://<device's IP address>:8000/`

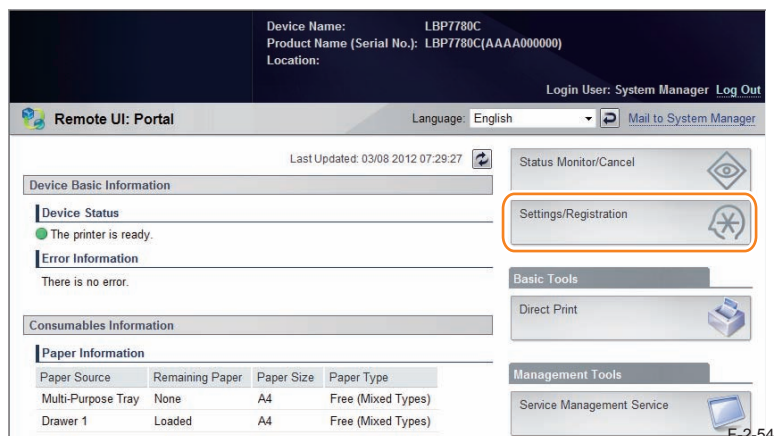

F-2-54

2) Click [Management Settings] > [Security] > [Key and Certificate Settings].

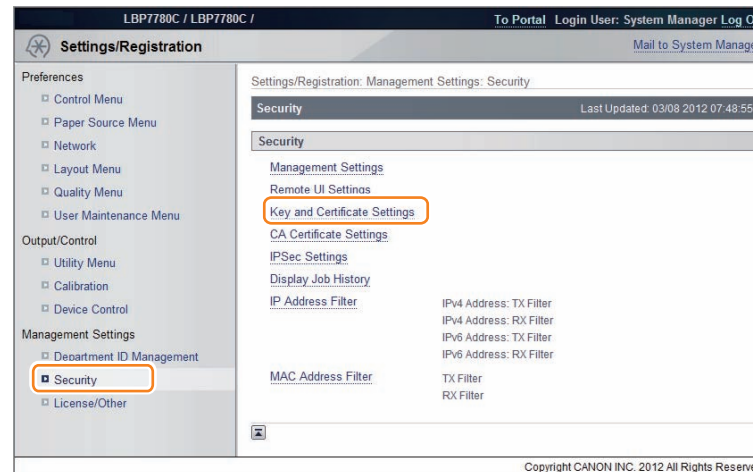

F-2-55

3) Click [Generate Key...] button.

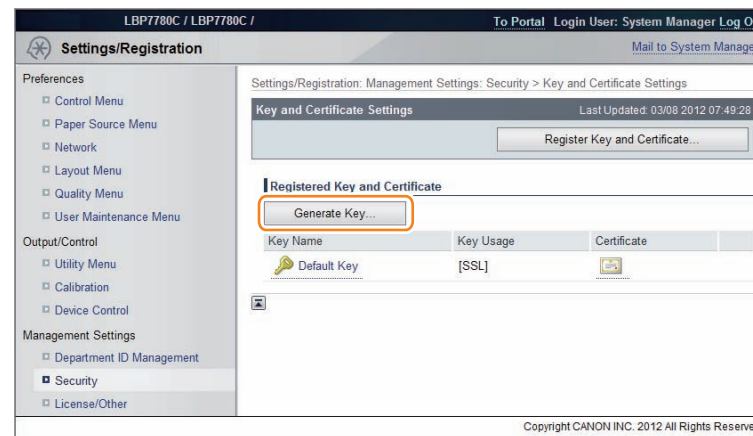

F-2-56

4) Enter the necessary information, and then click the [OK] button.

F-2-57

Input example

Item name	Type	Content	Entry
Key Settings			
Key Name	Compulsory	An arbitrary character string	Default Key
Signature Algorithm	Compulsory	Selected from:SHA1/SHA256/SHA384/SHA512	RSA
Key Algorithm	Compulsory	Selected from:512/1024/2048/4096	512
Certificate Settings			
Validity Start Date	Compulsory	Date	15/5/2011
Validity End Date	Compulsory	Date	15/5/2036
Country/Region	Compulsory	Country or region name	US
State	Arbitrary	State name	-
City	Arbitrary	City name	-
Organization	Arbitrary	Organization name	-
Organization Unit	Arbitrary	Organization unit	-
Common Name	Arbitrary	Common Name*	-

T-2-12

Note:

When the IP address of the device has been entered in the [Common Name] entry field, if you install a server certificate to the browser (see "Installing a server certificate (reference information)"), the message "Certificate Error" that usually appears when access is made from Internet Explorer 7 or later will not be displayed.

5) Check to see that the generated key appears in [Registered Key and Certificate].

F-2-58

Default Key Settings

1) Click [Preferences] > [Network] > [TCP/IP Settings].

F-2-59

2) Click [Key and Certificate...] button.

F-2-60

3) Select the generated key, and then click the [Default Key Settings] button.

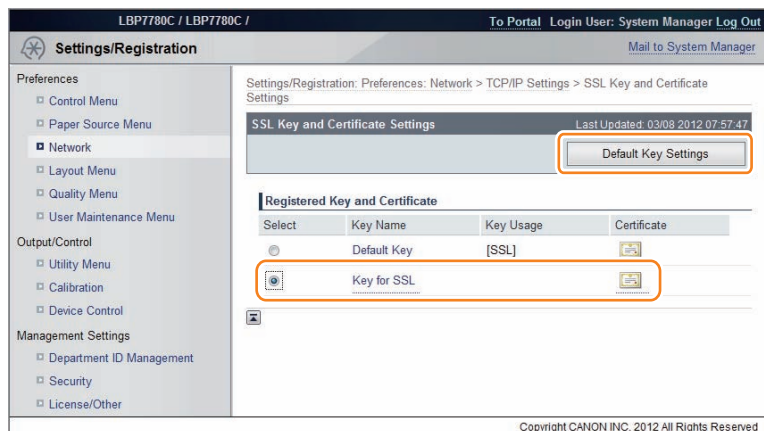

F-2-61

4) Check that [SSL] is displayed in the [Key Usage] entry field.

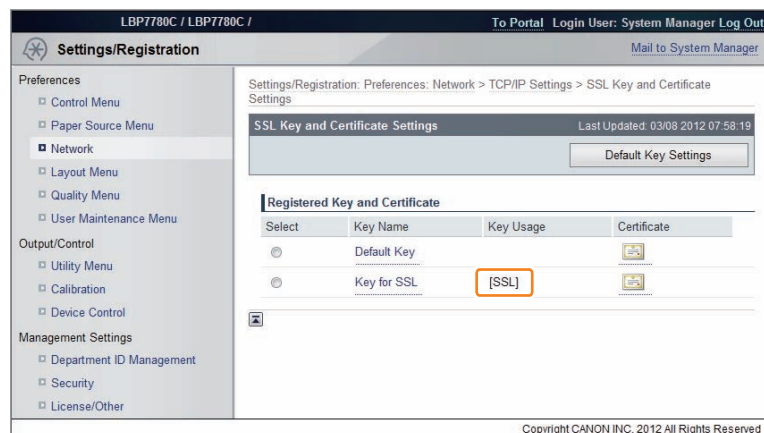

F-2-62

5) Log out from the remote UI, and then restart the device.

Installing a server certificate (reference information)

On Internet Explorer 7 (IE) or later, if [Default Key] installed as standard on the device is used, "Certificate Error" appears during access due to "Internet Explorer Enhanced Security Configuration".

Error display example



F-2-63

To disable display of "Certificate Error", use the following procedure (for IE8) to set the key generated in "Key Pair and Server Certificate when Using Encrypted SSL Communication" (i.e. the key with the IP address of the device specified as the shared name) as an SSL key.

1) Access SMS from the browser, and then click "Certificate Error" in the URL entry field.



F-2-64

2) Click [View certificates].

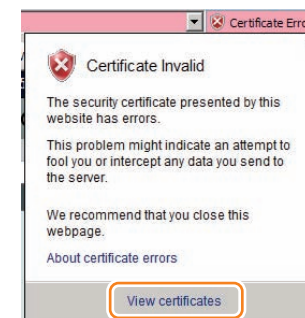

F-2-65

3) Click the [Install Certificate...] button on the [General] tab.

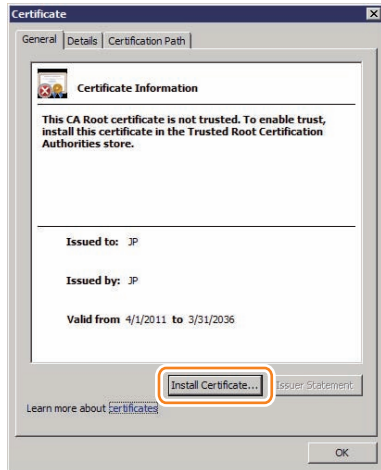

F-2-66

4) [Certificate Import Wizard] will appear. Click the [Next] button.



F-2-67

5) In [Certificate Store], select the [Place all certificates in the following store] option, and then click the [Browse] button.

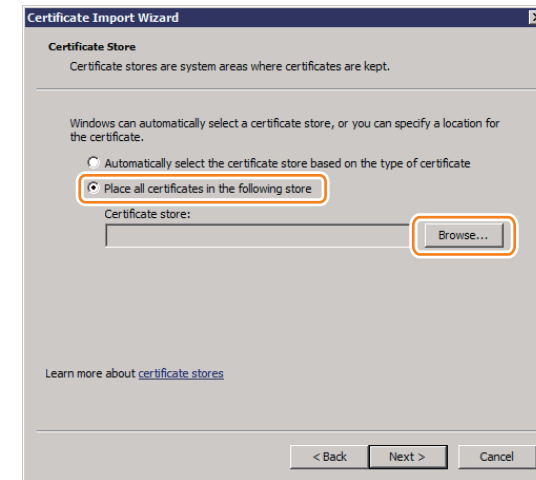

F-2-68

6) In [Select Certificate Store], select [Trusted Root Certification Authorities], and then click the [OK] button.

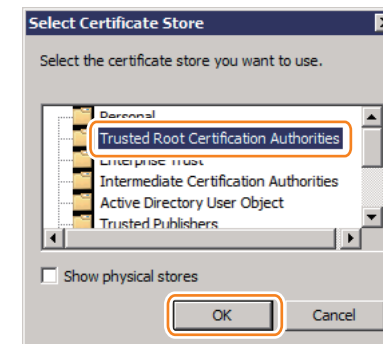

F-2-69

7) You will return to the [Certificate Store] dialog. Check that "Trusted Root Certification Authorities" appears in [Certificate], and then click the [Next] button.

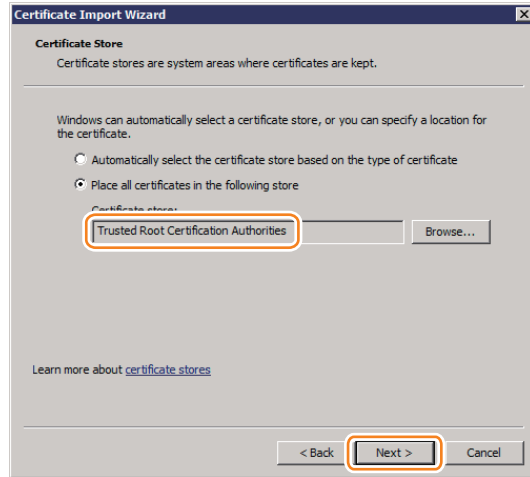

F-2-70

8) [Completing the Certificate Import Wizard] will appear. Click the [Finish] button.

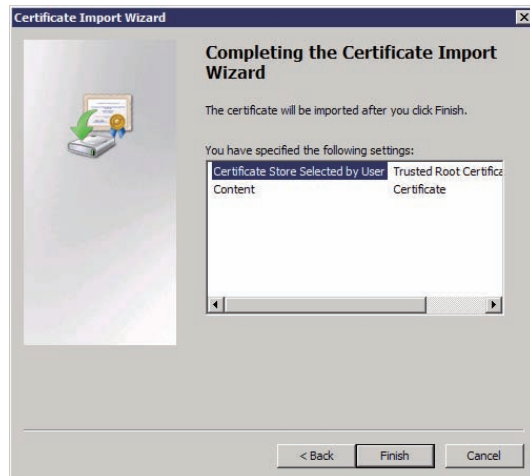

F-2-71

9) If the [Security Warning] appears, click the [Yes] button. (It does not appear when installing the same certificate again.)

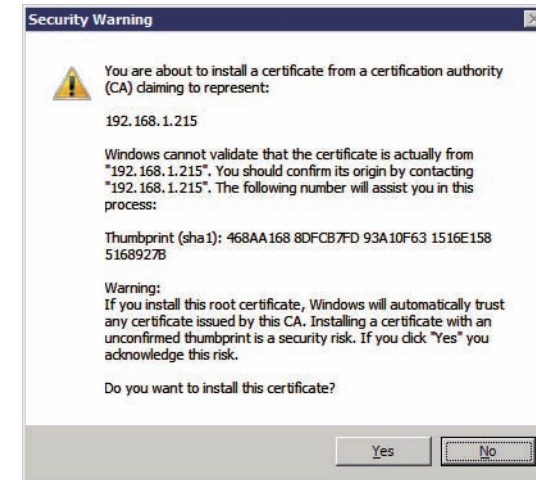

F-2-72

10) A message will appear to indicate that import has been completed successfully. Click the [OK] button.



F-2-73

Network Port Settings

The default port of the HTTP server used for MEAP and MEAP applications to provide the servlet function is 8000, and the HTTPS server's default port is 8443. In the case that these ports have already used by the customer who is to introduce this application, the MEAP application cannot use the HTTP (or HTTPS) server(s).

By changing the following ports to use, however, the MEAP application can be used as well as the existing system.

The procedure for setting the HTTP/HTTPS server port is shown below.

- 1) Start service mode. From the [Setup] menu, select [SERVICE MODE] > [FUNCTION GR.] > [MEAP].

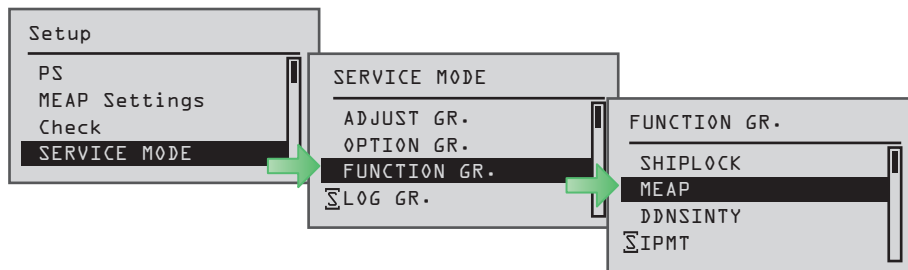

F-2-74

- 2) To set up the HTTP server port, select [MEAP-PN]. To set up the HTTPS server port, select [MEAP-SSL]. When the port number setting screen appears, specify a port number. Use the Up and Down keys to specify the setting.

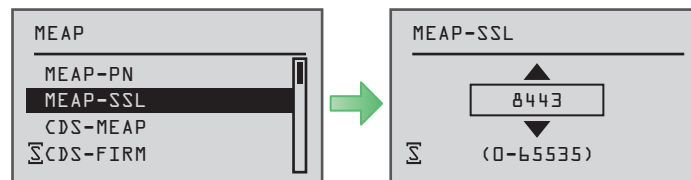

F-2-75

Note:

A port number can be any integer from 0 to 65535. To avoid port numbers that are frequently used, do not use any integer from 0 to 1023.

Server	Setting value	Default value / Value after RAM clear
HTTP Server	1024 to 65535	8000
HTTPS Server	1024 to 65535	8443

T-2-13

Note:

If PS Print Server Unit is connected, do not specify port 8080. If port 8080 is specified, the RUI of the device where the MEAP authentication application is running cannot be displayed. (Port 8080 is reserved to allow the PS Print Server Unit to redirect to the iR device.)

- 3) Restart the device if the port number is set.

How to Check the Serial Number

When performing MEAP device support, the serial number of the device is necessary in some cases.

Examples of where the serial number is necessary

- When initializing SMS login password (obtaining a switch license)
- When obtaining a MEAP application license from LMS
- When obtaining a transfer license of MEAP application
- When obtaining a special license for reinstalling MEAP application

If a problem occurs in the MEAP device and you want to contact the support department of the sales company, you need to provide the serial number. Perform the following procedure to get the serial number.

Checking from the PC browser

The serial number of the device is displayed on the SMS login screen, SMS screen, and remote UI portal screen.

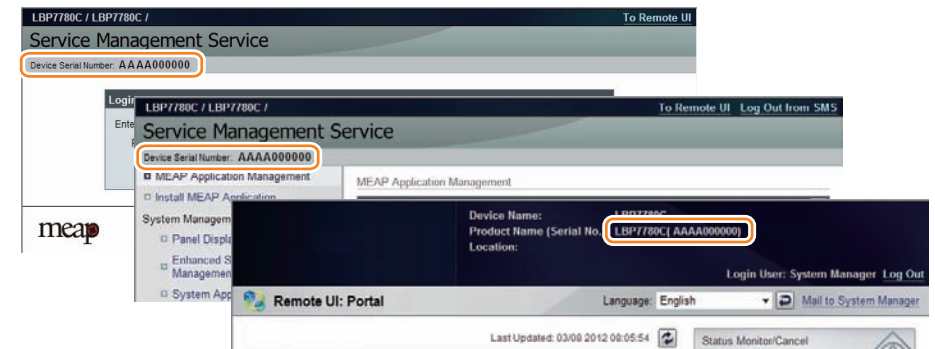

F-2-76

● Checking from the device's Control Panel

From [Utility Menu], select [Serial Number].

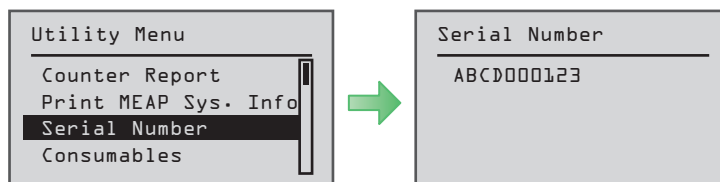

F-2-77

Note:

While MFPs of iR and iR-ADV series have 8-digit serial numbers, this machine (SFP) has a 10-digit serial number.

● Login to SMS

■ Procedure to Log in

Use the following procedure to log in to SMS.

1) From a browser of a PC on the same network as the device, enter the following URL to access SMS.

URL: `https://<MEAP Device IP address>:8443/sms/`

Ex.) `https://172.16.188.240:8443/sms/`

Note:

To encrypt the password information input when logging in, SSL of the login screen was made effective. However, even if you access SMS using a URL that has not been encrypted with SSL (non-SSL), you will be redirected to a SSL encrypted URL (SSL enabled).

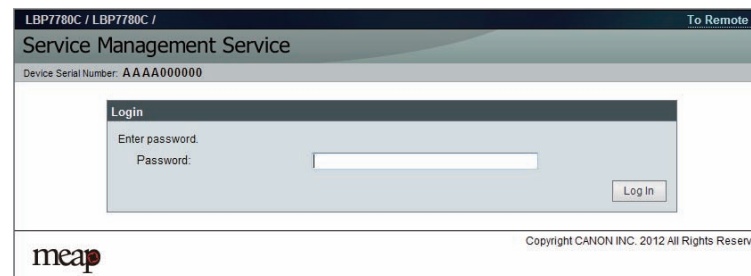

F-2-78

2) Enter the SMS login password in the password entry field, and then click the [Log In] button.

Note:

- The default password is "MeapSmsLogin." (The password is case-sensitive.)
- When you want to change the display original language, change in the box in the right of the screen. This setting is not affect by the setting of the language of the device.

Note:

SMS Access can be gained also from Remote UI.

Access Remote UI and click on SMS shortcut shown on the lower right of the screen to gain access to SMS.

Device Name: LBP7780C
Product Name (Serial No.): LBP7780C(AAAA000000)
Location:

Login User: System Manager Log Out

Remote UI: Portal Language: English Mail to System Manager

Last Updated: 03/08/2012 07:29:27

Device Basic Information

Device Status
The printer is ready.
Error Information
There is no error.

Consumables Information

Paper Information

Paper Source	Remaining Paper	Paper Size	Paper Type
Multi-Purpose Tray	None	A4	Free (Mixed Types)
Drawer 1	Loaded	A4	Free (Mixed Types)

Remaining Toner

Item Name	Remaining Toner
Cyan Toner	16-100%
Magenta Toner	16-100%
Yellow Toner	16-100%
Black Toner	16-100%

Waste Toner Container Status
OK

Message Board
Message from System Manager:

Support Link
Support Link: <http://www.canon.com>

Copyright CANON INC. 2012 All Rights Reserved

F-2-79

● When SMS Cannot Be Accessed

If you forgot the password (SMS login password initialization)

After changing the default SMS login password, if you forgot the new password and cannot log in to SMS, you can use a switch license for password initialization to change the password back to the default value "MeapSmsLogin".

Note that there is no special password for service.

1) Obtain a switch license file for password initialization.

Contact the person in charge of support at the sales company, give the device's serial number, and have a switch license file for password initialization issued.

2) Load the switch license file.

With nothing entered, click the [Log in] button to display the area for specifying a switch license file for password initialization.

LBP7780C / LBP7780C / To Remote UI

Service Management Service

Device Serial Number: AAAA000000

• Password is incorrect. Enter correct password.

Login

Enter password.
Password: Error

Initialize Password

Select a switch license file to use in initialization.

Switch License File Path:

* Specify a file with an '.sw2' extension.

meap Copyright CANON INC. 2012 All Rights Reserved

F-2-80

3) Specify the switch license file.

Click the [Browse] button and specify the switch license file.

4) Initialize the login password.

Click the [Initialize] button to display an initialization confirmation page, and click the [OK] button.

Note:

- The default password is "MeapSmsLogin." (The password is case-sensitive.)
- If you click the [Cancel] button on the initialization confirmation page, password initialization is not performed and the login page appears.

● If login is not possible due to exclusive control

Because SMS uses exclusive control, if there is another user already logged in to the SMS of the same device, then you cannot log in.

Exclusive control message example

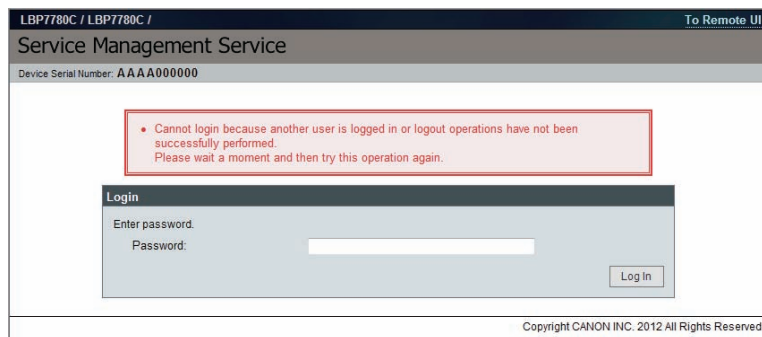

F-2-81

If you cannot log in due to exclusive control, you need to ask the other user to log out before you can try again.

Note:

If you close the browser without logging out, the session remains active. In this case, you cannot log in again.
If this problem occurs, you can wait for 5 minutes so that the session is disconnected.
Or, you can restart the device to force the session to disconnect.

● If [Key and Certificate Settings] is not set

If [Key and Certificate Settings] is not set correctly, you cannot access the URL for SMS (<https://<device's IP address>:8443/sms/>). In this case, you can use the following procedure to solve the problem.

- 1) Go to <http://<device's IP address>:8000/sms/>, and check to see that "HTTP 500 Internal Server Error" appears.
- 2) If the message is displayed, see the procedure described in "Key Pair and Server Certificate when Using Encrypted SSL Communication" in this manual to deal with the problem.

Note:

As for SMS, by setting the key to be used, encrypted SSL communication is always executed regardless of the following setting: (Settings/Registration) > [Management Settings] > [License/Other] > [MEAP Settings] > [Use SSL] > ON/OFF.

● How to deal with a message "Certificate Error" appearing during access

If "Certificate Error" appears when you access SMS from a browser, refer to the procedure described in "Installing a server certificate (reference information)" in this manual to deal with the problem.

Installing an MEAP Application

Outline

From the MEAP application installation screen, you can install the MEAP application as well as the license file.

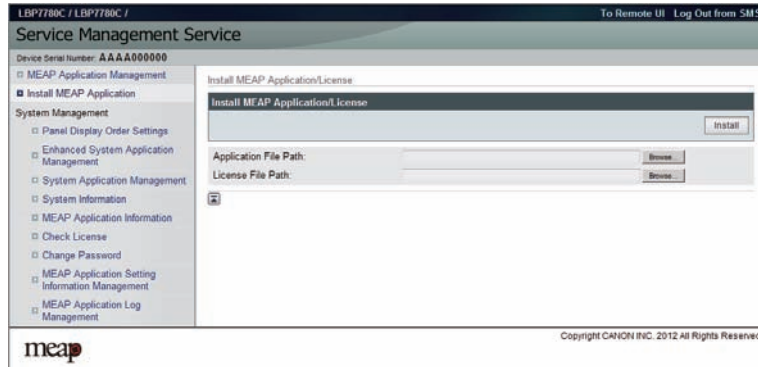

F-2-82

Before installing the MEAP application, be sure to check the following items.

Device compatibility with the MEAP application

To find out whether the device is compatible with the MEAP application, check the devices supported by the MEAP application. Depending on the application, the device's firmware may require version upgrade.

Resources availability (remaining amount)

The necessary resources (free storage space and free memory available) must be secured for an MEAP application to run; otherwise, you cannot install the MEAP application.

To check the resource information, see "Device's resources," on p. 2-55. in this manual.

Procedure to install applications

- 1) Long on to SMS.
- 2) Click [Install MEAP Application] on the menu.

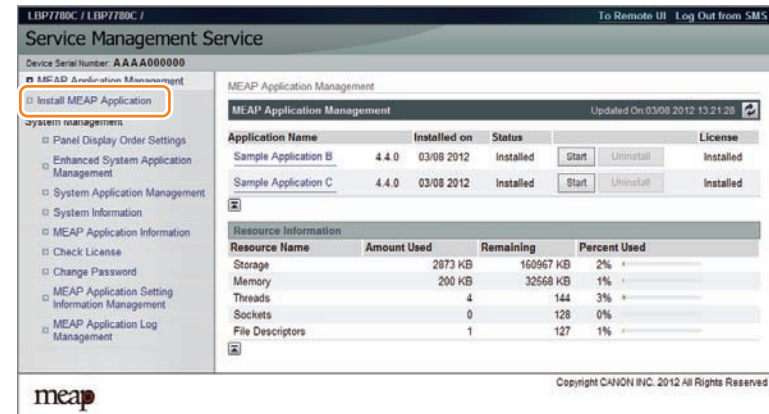

F-2-83

- 3) Check [Install MEAP Application/License] page appears.
- 4) Click [Browse..] button, and select the application file and the license file of the application; then, click [Install] button.

Note:
 Application File: identified by the extension "jar".
 License File: identified by the extension "lic".

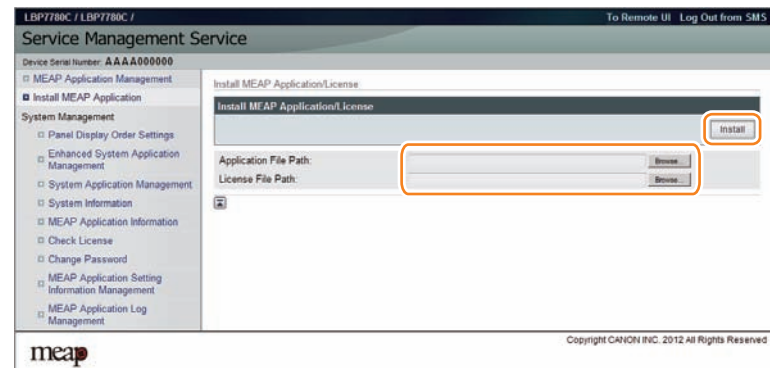

F-2-84

CAUTION:

- You cannot install only the license.
- You will not be able to install the application without using the appropriate license. Be sure to select its license file.
- If you are adding a license to an existing application, see "Procedure adding a license file".
- If you are updating an existing application, stop the application; then, install the new application or its license file. You will not be able to update an application while it is running.

5) Check the contents of the Confirm page; then, click [Yes] button.

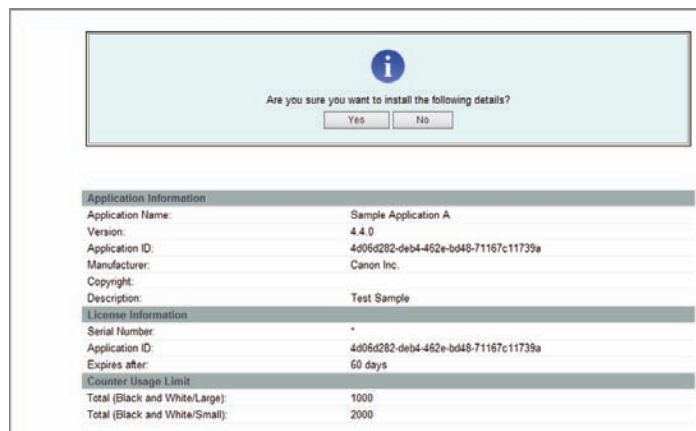

F-2-85

6) Some applications show a screen to indicate the terms of agreement. Read the terms, and click [OK].

7) Check the message "Installing...Please wait." appears, beginning the installation.

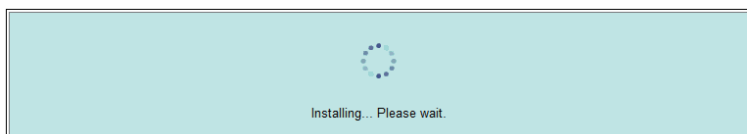

F-2-86

8) Upon installation completed, click [To MEAP Application Management] button shown on the screen to view MEAP Application Management page.

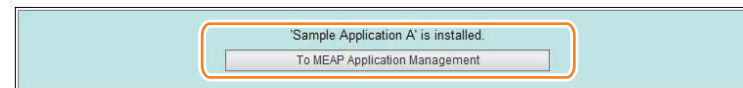

F-2-87

Note:

To use the application that you have just installed, you must make sure that the application status is Started.

Note:

The license file is provided in text file format, enabling to view in a text editor. The application ID and device serial number shown in the file allow users to confirm which device to install with the license file.

Note that any changes added to the license file may disable installation. Cares should be taken when confirming the contents of the license file.

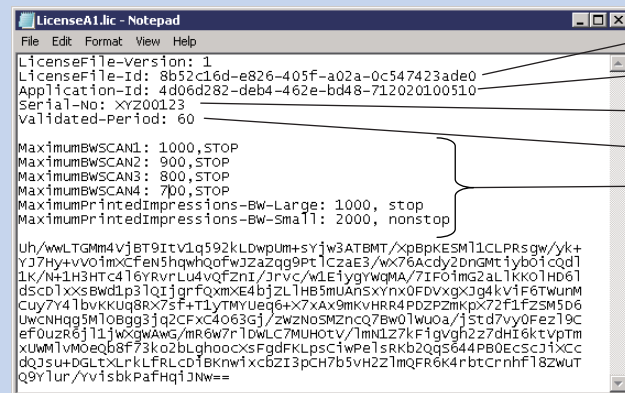
Sample file

License File ID

Application ID

Serial Number

Validated Period

Counter informations

F-2-88

Note:

There are two ways to install an MEAP application. You can install using SMS, or install using the [Register/Update Software] screen of the remote UI.

Screen example

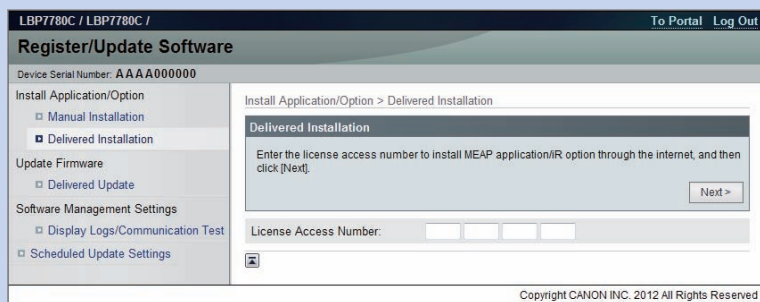

F-2-89

[Register/Update Software] provides two types of installations. One is [Manual Installation] where you specify a jar file and a license file and then install. The other is [Delivered Installation] where you enter a license access number. For details of the procedures, please refer to the e-Manual.

Resource Information

About MEAP Application Management Page

Application Management page shows [resource information] for information of the whole device resources including Amount Used, Remaining, and Percent Used.

This function enables users to judge the remaining resources before installing the additional application. Such resource information is shown based on the manifest header stated at the top of each application, which declares the resources required in the application. Therefore, the information does not necessarily show the resources actually in use.

The following resource information is shown:

- Storage
- Memory
- Thread
- Socket
- File Descriptor

You will not be able to install an application if the size of the remaining disk space falls short of the size declared by the application. Moreover, the specifications have been designed so that an application will not be able to start up if there is a shortage of memory for any of the foregoing items (i.e., memory, thread, socket, file descriptor).

Follow the steps below to check the remaining memory:

- 1) Log in to SMS.
- 2) Click [MEAP Application Management].
- 3) Check [Resource Information] for information of the whole device resources.

Resource Name	Amount Used	Remaining	Percent Used
Storage	2877 KB	160963 KB	2%
Memory	400 KB	32368 KB	1%
Threads	4	144	3%
Sockets	0	128	0%
File Descriptors	1	127	1%

F-2-90

● Device's resources

When 1 MEAP application operates, the resource volume allocated to each device is as follows (loaded resource list). Since the following value is an estimate, when installing the MEAP applications, it needs to check the available resource of SMS.

Since the indication of SMS resource volume fluctuates by the login service (authentication function) and configuration (future model), which the user selected, it may show a bigger value than the following values.

List of Available Resources

Product Name	Storage	Memory	Thread	Socket	File Description
i-SENSYS LBP7680Cx/ imageCLASS LBP7680Cdn	160MB	32MB	148	128	128
i-SENSYS LBP6680x/ imageCLASS LBP6680x	160MB	32MB	148	128	128

T-2-14

Note:

- As for memory, check the available resource when starting up the application. For other resources other than memory, check them when installing.
- Some applications call for a specific set of conditions for installation. For details, see the User's Guide that comes with the individual applications.
- Maximum installable application is up to 8 even if the remaining resource is adequate. (However, the Send function consumes 1, it must be 19 in practice.) Authentication application is not included in this number.
- The MEAP application, which can be started simultaneously, is up to 5. (Authentication application is not included in this number.)

CAUTION:

To install an application, the user needs to use the following URL when accessing the license control system to obtain a license file. In doing so, he/she needs to register the license access number of the application and the serial number of the device.

<http://www.canon.com/lms/license/>

● MEAP Specifications

■ What is MEAP Specifications (MEAP Spec Version)?

MEAP Specifications is one of the information required to judge whether MEAP applications can be operated or not. With MEAP Specifications, you can prevent an application that uses a specific function of device from being installed onto the device that does not have the function.

● About Name

MEAP Specification is shown as 'MEAP Specifications' in the screen to check the version on the side of device that supports MEAP (counter confirmation button) and MEAP platform (SMS). On the other hand, in the manifest file of MEAP application, it is shown as 'MeapSpecVersion' (described in the same way in the SDK document) (Note) 'MEAP Specifications' hereafter in this document.

● Mechanism

MEAP platform judges whether MEAP applications can be operated on it using on the 2 information below:

- Device Specification ID
- MEAP Specifications

Device Specification ID shows information such as the original functions of the device (including print, scan, and copy), and one that differs by model such as maximum copy number, thus each model has a different ID. (It is easy to determine the IDs for this reason.) MEAP application declares 1 or more Device Specification ID required for its execution. Declaration of multiple Device Specification IDs means that the application is operable in all the models declared. Upon installation of MEAP application in (using) SMS or MEAP Enterprise Service Manager, matching of Device Specification ID is executed on the side of MEAP platform machine. The machine which doesn't support the ID declared by the application rejects installation of such an application. Meanwhile, MEAP Specifications shows other information than defined by Device Specification ID above, including network and security. Thus each model does not always have the same version.

MEAP application declares 1 or more MEAP Specifications required for its execution. Declaration of multiple Device Specification IDs means that the application is operable in all the environments declared. Upon installation of MEAP application in SMS or MEAP Enterprise Service Manager, matching of MEAP Specifications is executed on the side of MEAP platform machine. The machine which doesn't support the version declared by the application rejects installation of such an application.

MEAP Specifications for each model

Product Name	Initial MEAP SpecVer
i-SENSYS LBP7680Cx/ imageCLASS LBP7680Cdn	11, 15, 18, 19, 25, 26, 27, 29, 34, 39, 43, 45, 47, 50, 51, 52, 54, 55, 57, 58, 60, 61, 62, 63, 74, 75, 76, 77
i-SENSYS LBP6680x/ imageCLASS LBP6680x	11, 15, 18, 19, 25, 26, 27, 29, 34, 39, 43, 45, 47, 50, 51, 52, 54, 55, 57, 58, 60, 61, 62, 63, 74, 75, 76, 77

T-2-15

MEAP Specifications List

Ver	Description
1	MEAP basic function
2	MEAP Spec Version 1 function and SSL/TSL + Proxy
5	MEAP Spec Version 1 function and CPCA V2 + ERS (Error Recovery Service) + New SSL/TSL
6	Reserved
7	MEAP Spec Version 5 function and Compact PDF + OCR PDF (Text Searchable) + USB Host (Buffering of Interrupt Transfer)
9	Reserved
10	MEAP Spec Version 5 function and USB-Host (Exception + Clear Feature + Set Feature+ Hot Plug) + WINS address acquisition using MIB Agent + Timer Service + SSL client authentication
11	MEAP Spec Version 5 function and AMS
13	MEAP Spec Version 5 function and J2ME1.1 Support + Encrypted PDF + Trace and smooth PDF + CTK2.0
14	Device signature PDF
15	IMI + ERS (API addition for IMI) , IPv6, Extended encryption function (AES/RC4)
17	Acquiring images of JBIG format
18	Parsing XML documents (XML parser)
19	Enhancement of IMI function (IMI Version1.2 series)
21	Reserved
25	API to access the HID/Mass Storage class devices.
26	MEAP driver preference function
27	Symbols that can be used with MibAgent added. (symbols for IPv6 address acquisition)
29	IMI API added (IMI version 1.2.1 enabled)
30	Extended address book function. (e-mail/group/i-FAX/file)
31	Integrated ERS function
32	Extended Imaging function (function to generate PDF/OOXML (PowerPoint) with visible signature)
33	Extended function for iR / iR ADVANCE series (API for address book/ CTK/ TopMenu)
34	Extended IMI Box function (v1.3.0)
35	Extended SIS function (function to check the network cable status, function to check PS print server unit status)
36	Reserved
37	CLS (Contextual Login Service) Supporting API Added
38	iR / iR ADVANCE Series administrative privileges supported
39	MEAP Specifications added according to Jcrypto API Specification Change

Ver	Description
40	ImagingAPI (Creation API of Visible Signature PDF) added
41	Reserved
42	Reserved
44	iR / iR ADVANCE Series Remote Address Book Supported, RemoteFAX Supported.
45	Addition of API that allows acquisition of the HID installation status
46	Multilingualization of the USB keyboard of the System Driver
47	Addition of API which executes a print order from the MEAP application of the IMI encryption PDF document
48	ID expressing the scan function for iR-ADV C2030/C2025/C2020 series
49	Reserved
50	SecurityOptionalPackage
51	IMI function expansion of iR-ADV C5051 series (Ver.50.xx or later) or later
52	(iR-ADV C5051 series (Ver.50.xx or later)) Addition of registered API to enable SSL communication setting (On/Off) for each URL
53	Disclosure of registration/deletion function to/from Quick Menu
54	Function to notify an event to the application at recovery from the sleep mode.
55	System account release function
56	MEAP User Preference Service
57	MEAP Application Configuration Service
58	MEAP Application Log Service
59	Reserved
60	SFP basic functions
61	LAVS
62	LSIS
63	LDT
64	IMI customization
65	Extension of MEAP User Preference Service (application sharing preference).
66	Reserved
68	Addition of Office Open XML's Word creation API
69	Extension of the encrypted PDF function (AES 128 bit/256 bit)

T-2-16

MEAP Application Management

Outline

You can use the MEAP application management screen to perform basic management tasks of the MEAP application (start, stop, uninstall), or check the device's resource information.

Starting, Stopping, or Uninstalling the MEAP Application

Procedure to start and stop a MEAP application

- 1) Log in to the SMS. (Refer to 'Login to SMS' in this manual.)
- 2) Click [Application List]. (If the Application List is already being displayed, this operation is not necessary.)
- 3) Click [Start] or [Stop] button shown for the MEAP application to be started or stopped.

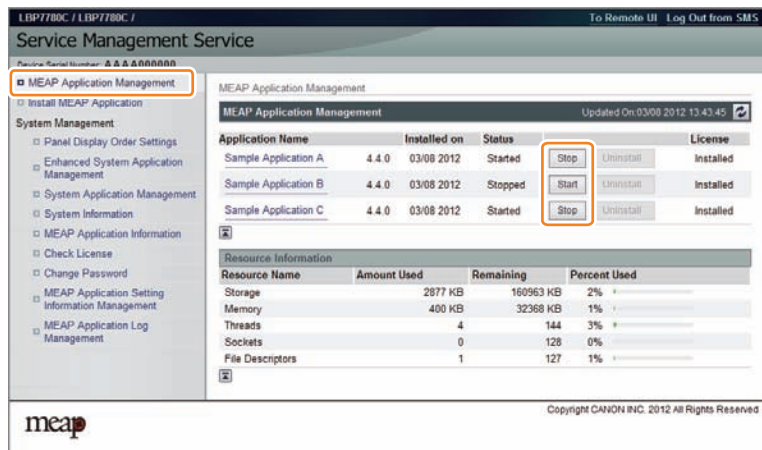

F-2-91

- 4) Check to see that the status of the MEAP application in question is either [Started] or [Stopped].

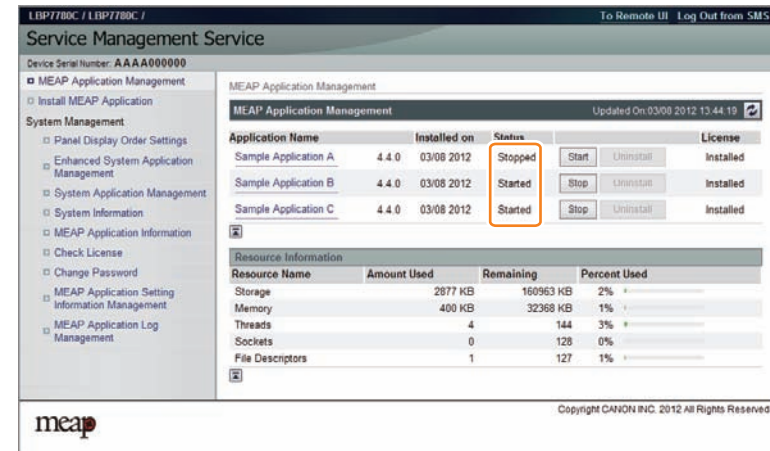

F-2-92

If the MEAP application cannot be started

If the conditions to start the MEAP application are not satisfied, the MEAP application cannot be started.

If the MEAP application cannot be started, check the following items.

Is a valid license installed?

If the license has expired, you cannot start the application. If the license has already expired, obtain a new license and then update the license. (See "Managing the License File" in this manual.)

Are the necessary resources available?

If the resources such as memory capacity or number of threads are not sufficient, the application also cannot be started.

Delete any unnecessary data to secure sufficient resources.

If the application still cannot be started after checking the foregoing conditions, contact the support department of the sales company.

Procedure to uninstall the MEAP application

Before uninstalling the MEAP application, check that the following conditions are met.

- The MEAP application has stopped.
- The license has been disabled or deleted. (The status is "Not Installed".)

MEAP Application Management

Application Name	Installed on	Status	Start	Uninstall	License
Sample Application A	4.4.0 03/08 2012	Stopped	Start	Uninstall	Not Installed
Sample Application B	4.4.0 03/08 2012	Started	Stop	Uninstall	Installed
Sample Application C	4.4.0 03/08 2012	Started	Stop	Uninstall	Installed

F-2-93

For information on the procedure to stop the MEAP application, see the previous section "Procedure to start and stop a MEAP application".

For information on the procedure to delete the license file, see the following section "Managing the License File".

Note:

When a user tries to uninstall an application before deleting the license, the following message is shown.

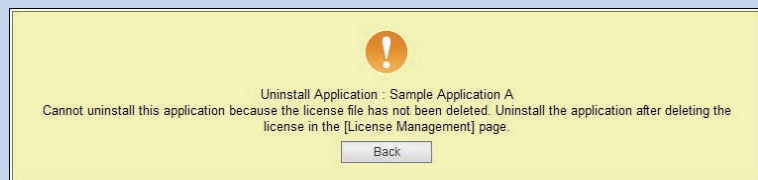

F-2-94

If the license file of the selected application cannot be deleted, the [Uninstall] button is grayed out and therefore the application cannot be uninstalled.

CAUTION:

If the application you are uninstalling is associated with another application, a message will appear to indicate that the package exported by the application will no longer be available. Uninstalling such an application may also disable its associated applications.

1) Log in to SMS to click [MEAP Application Management] on the menu.

2) Check that the status of the application you want to uninstall is [Stop] and the license has been disabled. (The status is "Not Installed".)

MEAP Application Management

Application Name	Installed on	Status	Start	Uninstall	License
Sample Application A	4.4.0 03/08 2012	Stopped	Start	Uninstall	Not Installed
Sample Application B	4.4.0 03/08 2012	Started	Stop	Uninstall	Installed
Sample Application C	4.4.0 03/08 2012	Started	Stop	Uninstall	Installed

F-2-95

3) Click [Uninstall] button for the application to be uninstalled.

Service Management Service

MEAP Application Management

Application Name	Installed on	Status	Start	Uninstall	License
Sample Application A	4.4.0 03/08 2012	Stopped	Start	Uninstall	Not Installed
Sample Application B	4.4.0 03/08 2012	Started	Stop	Uninstall	Installed
Sample Application C	4.4.0 03/08 2012	Started	Stop	Uninstall	Installed

Resource Information

Resource Name	Amount Used	Remaining	Percent Used
Storage	2677 KB	160963 KB	2%
Memory	400 kB	32368 KB	1%
Threads	4	144	3%
Sockets	0	128	0%
File Descriptors	1	127	1%

F-2-96

4) Check the application name to be uninstalled shown on the screen to click [Yes] button. Upon [Yes] button clicked, uninstallation process is started.

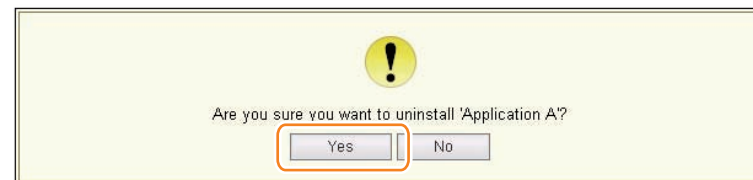

F-2-97

Managing the License File

Outline

The license file management functions allow you to perform the following operations related to the license file necessary for the MEAP application to run.

- Update the license which has already expired.
- Disable or delete the license file in order to uninstall the MEAP application.

These license management functions can be performed from the [MEAP Application Management] screen.

The main license management functions are as follows:

Adding a license

When the license has expired, you can add a license file.

Disabling a License File

Before uninstalling the MEAP application, the license needs to be deleted. In that case, you must first disable the license file because a license file which has not been disabled cannot be downloaded or deleted.

Downloading / Removing an Invalidated License File

Before uninstalling the MEAP application, you need to delete its license file which has already been disabled.

By downloading the license file to your PC before it is deleted, you can use it when installing the application again to the same device.

WARNING:

After deleting the license file which has been disabled, you can no longer download the license file.

Procedure adding a license file

- 1) Log on to SMS.
- 2) On MEAP Application Management, click the name of the application to which you want to add a license file.

The screenshot shows the 'Service Management Service' interface. On the left is a navigation menu with options like 'MEAP Application Management', 'System Management', and 'MEAP Application Information'. The main area displays 'MEAP Application Management' with a table of installed applications:

Application Name	Version	Installed on	Status	License
Sample Application A	4.4.0	03/08 2012	Started	Installed
Sample Application B	4.4.0	03/08 2012	Started	Installed
Sample Application C	4.4.0	03/08 2012	Started	Installed

Below the table is a 'Resource Information' section with a table showing usage:

Resource Name	Amount Used	Remaining	Percent Used
Storage	2877 KB	160963 KB	2%
Memory	500 KB	32268 KB	2%
Threads	4	144	3%
Sockets	0	128	0%
File Descriptors	1	127	1%

F-2-98

- 3) In [Application / License Information] page shown on the screen, click [License Management] button.

The screenshot shows the 'Application/License Information' page. It displays details for 'Sample Application A':

- Application Name: Sample Application A
- Version: 4.4.0
- Application ID: 4d06282-deb4-462e-bd48-71167c11739a
- Installed on: 03/08 2012
- Description: Test Sample
- Manufacturer: Canon Inc.

Below this is the 'Resources Used' section with a table:

Storage:	4 KB
Memory:	100 KB
Threads:	0
Sockets:	0
File Descriptors:	0

At the bottom, the 'License Information' section shows 'Status: Installed' and 'Serial Number: MMKA000036'. The 'License Management' button is highlighted with a red box.

F-2-99

4) Click [Browse] button, and select the license file you want to install.

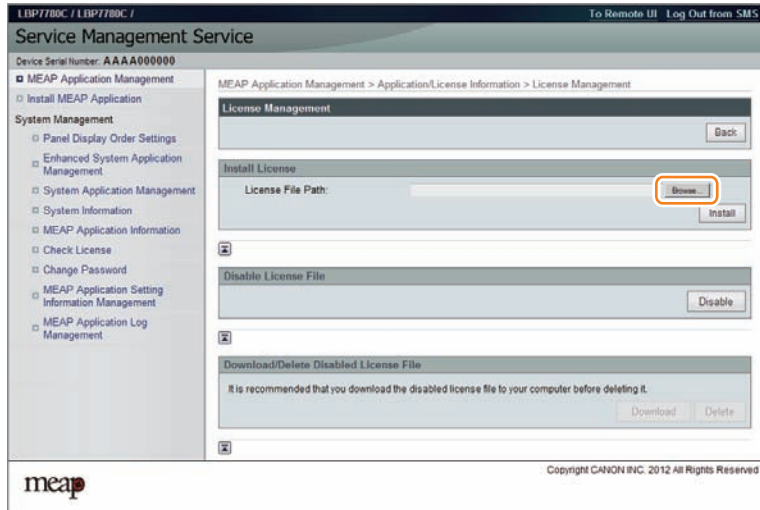

F-2-100

5) Click [Install] button.

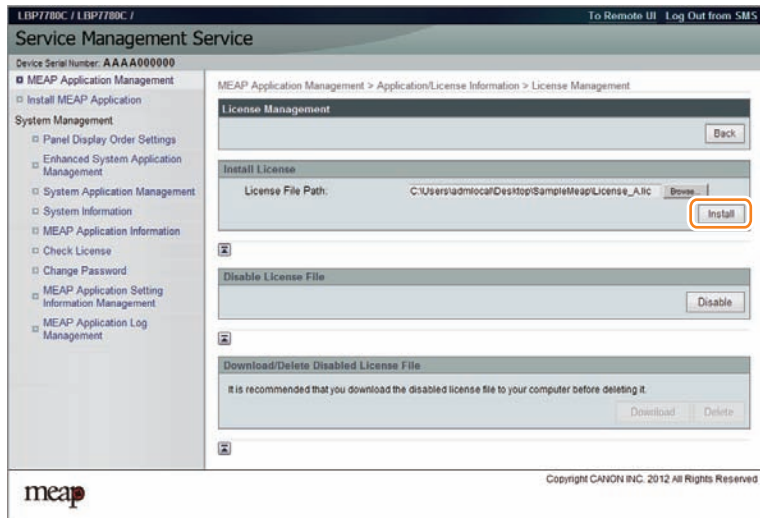

F-2-101

6) Check the content of the confirmation page, and click [OK] button.

● Procedure disabling a license file (suspending a license)

CAUTION:

- Since the license file cannot be disabled when the application is still running, the application needs to be stopped before disabling the license file.
- Once suspended, the status of the license will be 'Not Installed', and its application will no longer be available for use.
- You can later restore a suspended license file as long as you are doing so on the same iR, the device with the same device serial number.
- If the machine needs to be replaced due to a device failure, use the transfer license during the replacement. (See "License for forwarding")

1) Stop the application you want to uninstall on MEAP Application Management page.

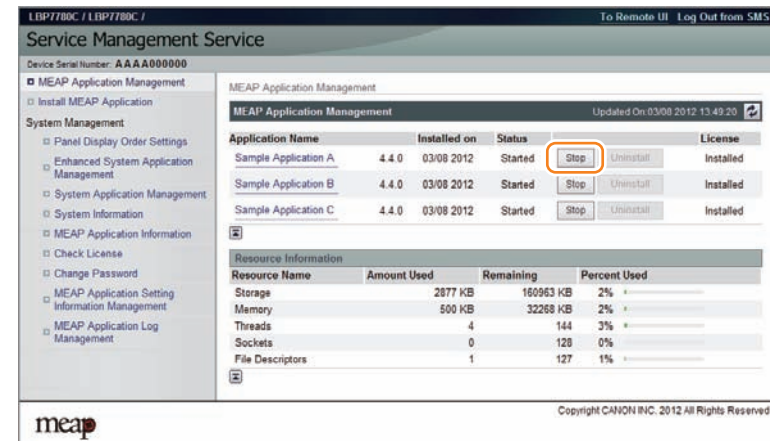

F-2-102

2) Click the name of the application that you want to disable.

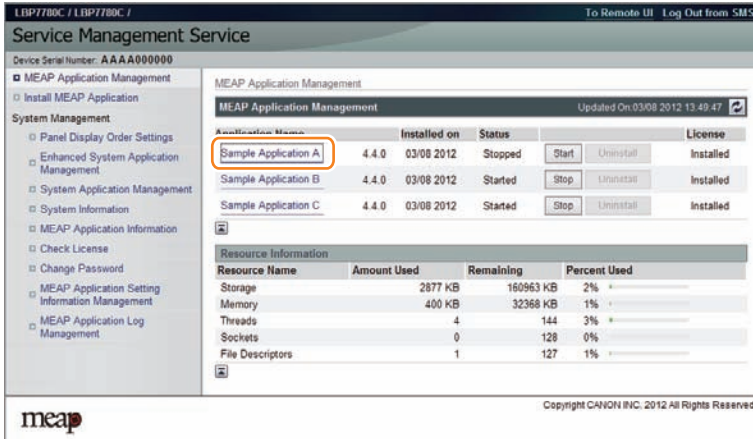

F-2-103

5) Click [Yes].

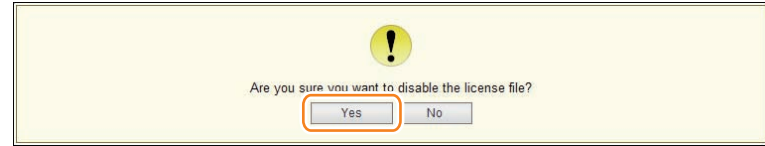

F-2-106

3) On Application/ License Information page, click [License Management] button.

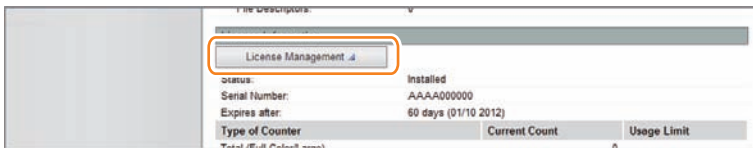

F-2-104

4) License Management page appears. Click [Disable] button.

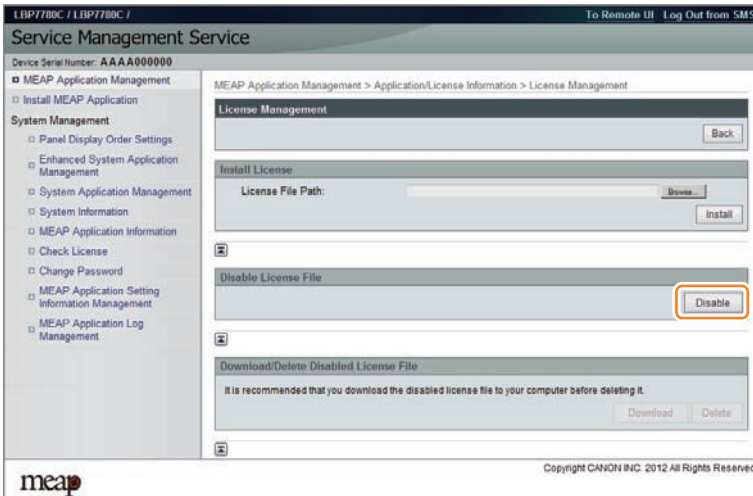

F-2-105

Procedure downloading / removing an invalidated license file

Note:

The downloaded license file can be used for reinstallation only in the same iR device (with the same device serial number).

- 1) Login to SMS.
- 2) Application List page appears. On MEAP Application Management page, click the name of the application you want.

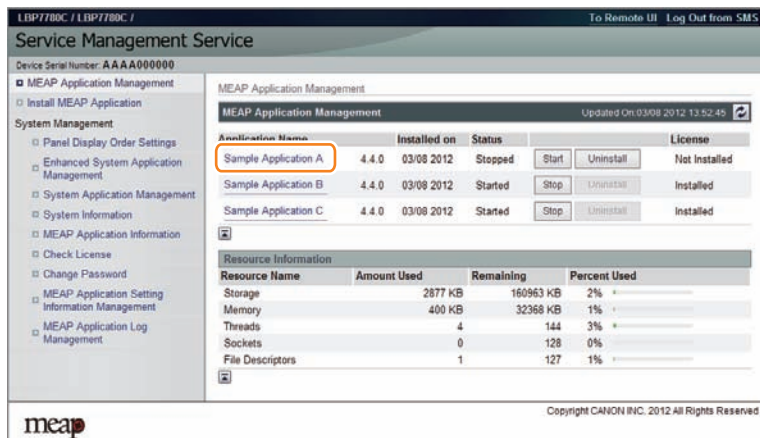

F-2-107

- 3) Check Application/ License Information page appears.
- 4) On Application / License Information page, click [License Management] button.

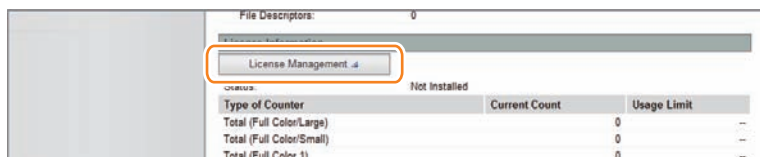

F-2-108

- 5) License Management page appears. To download, click [Download] button.

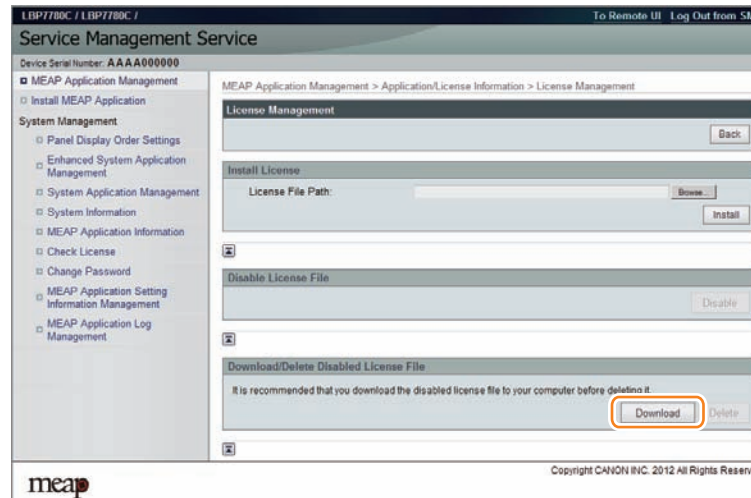

F-2-109

- 6) When you have selected [Download] button, specify where you want to store the file by following the instructions on the screen.

- 7) To delete, click [Delete] button.

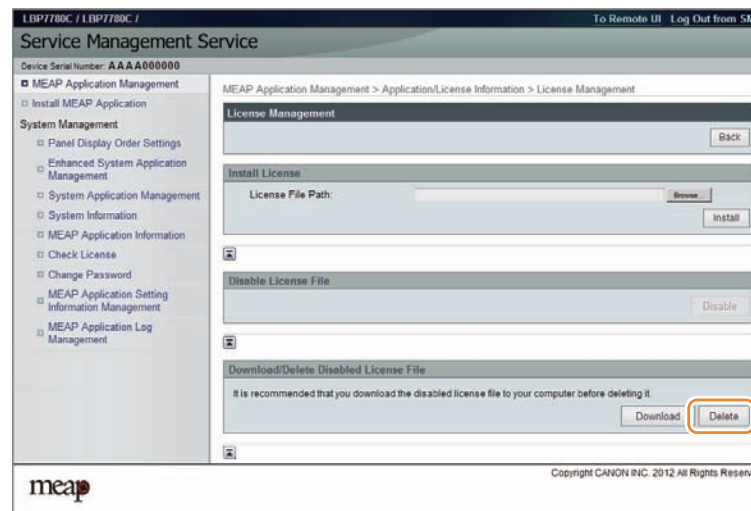

F-2-110

8) When the dialog to confirm deletion is shown, click [Yes] button.



F-2-111

WARNING:

Without the license file, an application cannot be reinstalled even to the MEAP de-vice that the application had been installed last time. Download and save the license file before deleting the application.

Other License File Management Functions

Reusable license

When reinstalling, Disable License file should be downloaded (see "Disabling a License File ." and see "Downloading / Removing an Invalidated License File." in this manual) or a license for reinstallation should be obtained from LMS, before reinstallation.

This specification aims to prevent misuse of applications.

To increase convenience of users, only application with unlimited validity date and application counter (e.g. Portal Service, SDL, SSO) has been made to be able to install as many times as needed by the same license file. This kind of license is called 'Reusable license'.

After replacing the Main PCB, the MEAP applications need to be reinstalled.

In that case, the installation requires use of reusable licenses.

As for other MEAP applications without reusable licenses, use special license files for reinstallation, in the same as way as handling a storage drive failure.

For information on how to obtain a special license for reinstallation, refer to "Special license for reinstallation" in this chapter.

License for forwarding

If the machine needs to be replaced due to a device failure, you can transfer the license information used in the MEAP application to the new machine and continue its usage. Service engineers are responsible for license transfer as this task requires the SMS hidden page (not open to users).

The procedure is shown below.

- 1) Log in to SMS, stop the application to be forwarded (see Chapter 0, "Starting and Stopping a MEAP Application." in this manual).

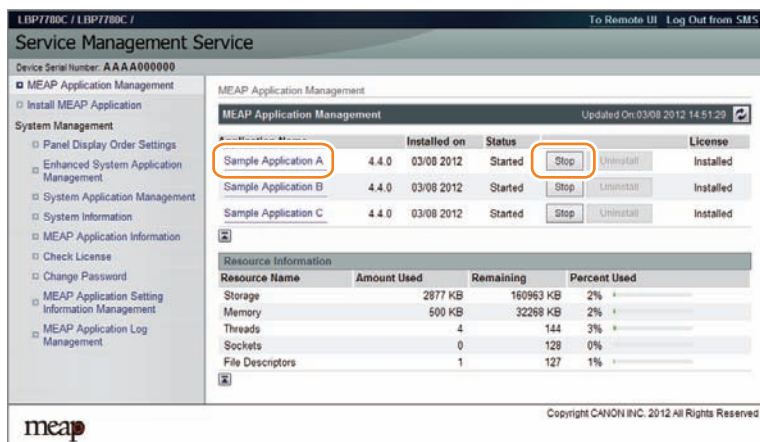

F-2-112

- 2) Move to the download page of license forwarded for the device as sender ([https:// IP address of device: 8443/sms/ForwardLicense](https://172.16.1.215:8443/sms/ForwardLicense)).



F-2-113

- 3) Specify the application to be forwarded.

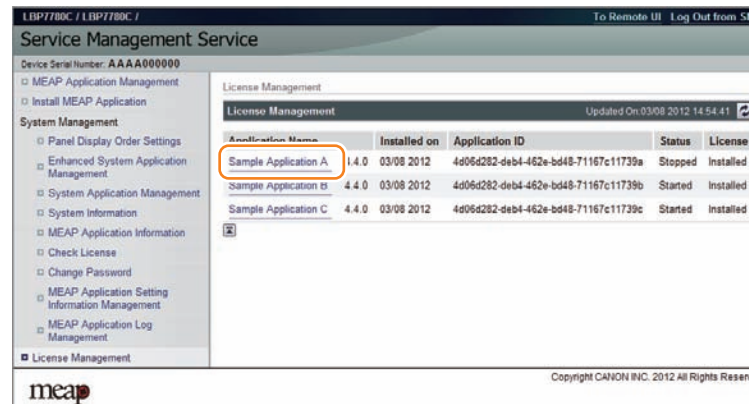

F-2-114

- 4) Click [Disable] button on the [Disable License File].

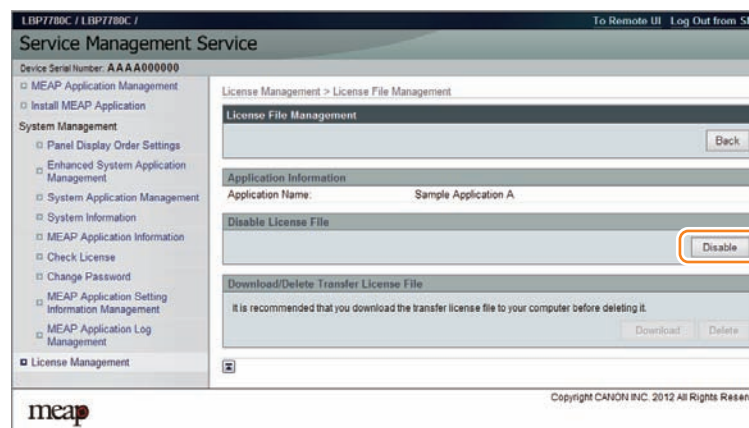

F-2-115

- 5) The window to confirm whether to create a transfer licence will be displayed. Click [Yes].



F-2-116

- 6) When [Download] button on the [Download / Delete Transfer License File] becomes effective, click [Download] button.

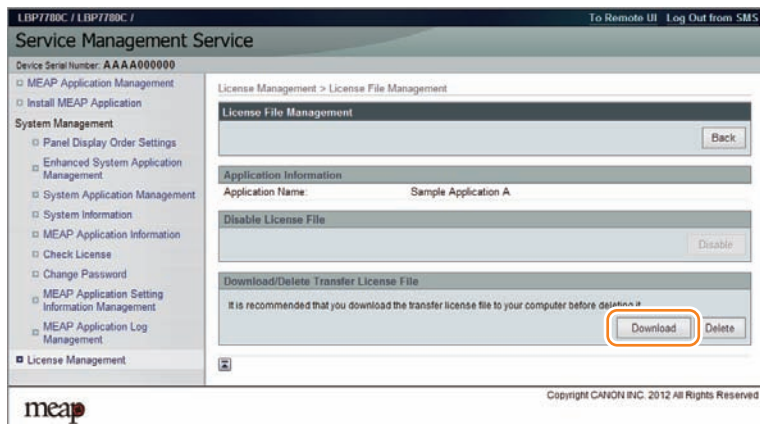

F-2-117

- 7) The dialogue [File Download] is displayed. Click [Save].

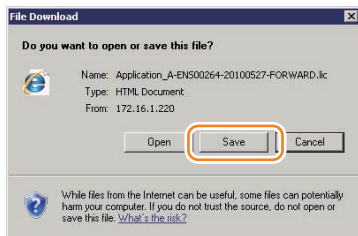

F-2-118

- 8) Specify the download destination, click [Save].

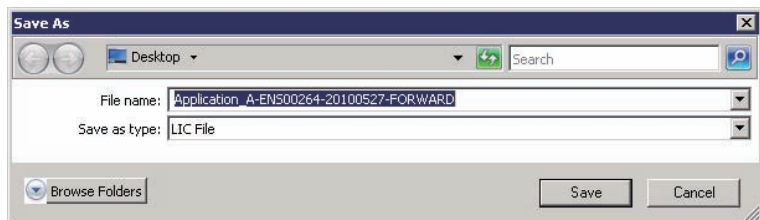

F-2-119

- 9) After downloading the license file for forwarding, click [Delete] to display the confirmation screen and click [Yes] to delete the file (in consideration of breakage of license for forwarding, deleting disabled license can be executed after all steps have been completed).



F-2-120

- 10) Log out of SMS.
 11) Since this downloaded transfer license is the file only to prove the license invalidation, it cannot be used for installation to the other device as it is. Send the transfer license to the service support contact of your nearest sales company to request issuance of the new license for installation in the new device.

Note:

When requesting issuance of license for forwarding, inform the sales company of the name of product name and serial No. of the device as sender, and of the name of product name and serial No. of the forwarding destination.

- 12) Install application using the license for forwarding issued by the sales company.

Enhanced System Application Management

Outline

[Enhanced System Application Management] mainly manages the login services for logging in to devices.

- Installing and uninstalling Enhanced System Application Management (login services, etc.)
- Switching login services (switching the method to log in to devices)
- Checking installation status of other System Applications

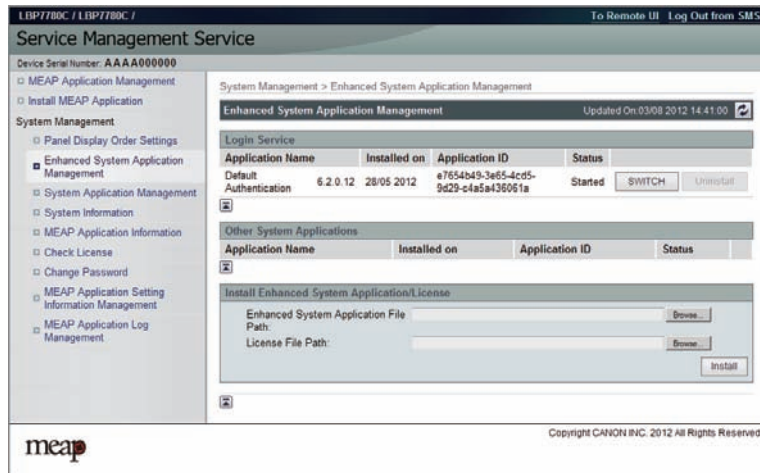

F-2-121

About Login Service

The login service is started up to authenticate the user when MEAP-enabled iR device is booted up. Login service changes and install/ uninstall are carried out from the 'System Management' page.

The pre-installed login application is Default Authentication, and the default setting is [Start].

Default Authentication overview

Default Authentication is a pre-installed login application that runs by default. It provides authentication functions to allow minimum operation of the Controller System, even when no other login application is running.

Other Log in service

There are login services besides the foregoing Default Authentication, such as card authentication. For details, refer to the manuals for those login services.

Procedure Changing Login Services

If 2 or more login services are installed, you can use the following procedure to switch among them.

- 1) Access SMS. From the [System Management] menu, select [Enhanced System Application Management].

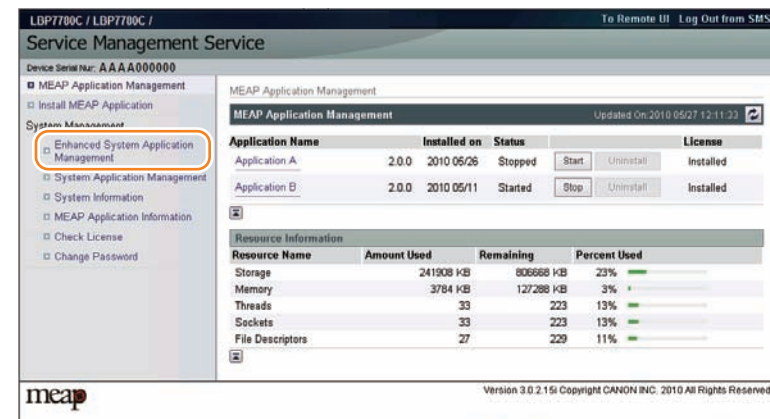

F-2-122

2) Click the [SWITCH] button of the login service you want to switch to.

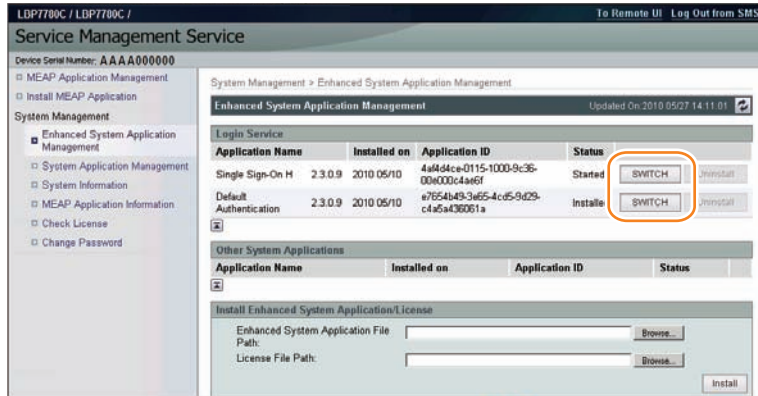

F-2-123

3) Check that the status of the selected login service application has changed to [Start after Restart]. Then, log out of SMS and restart the device.

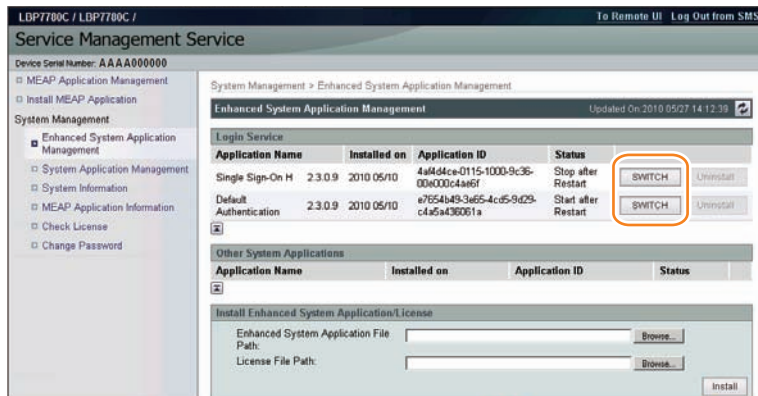

F-2-124

Procedure Installing Login Services

Use the following procedure to install the login services.

- 1) Access SMS, and then click [System Management] > [Enhanced System Application Management].
- 2) Click the [Browse] button, and specify the Enhanced System Application file/License file.

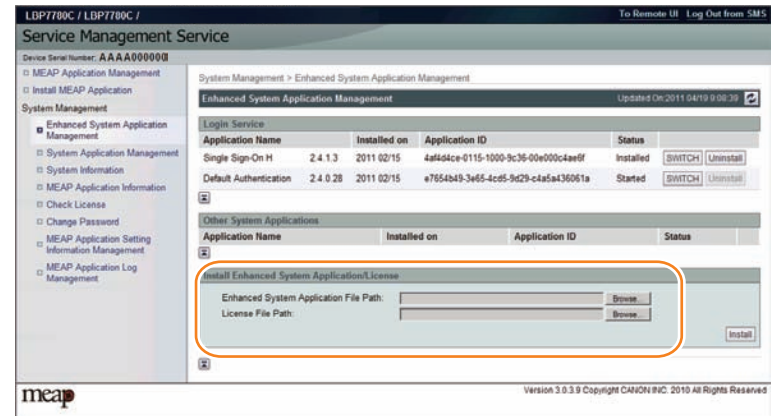

F-2-125

3) Click [Install] button.

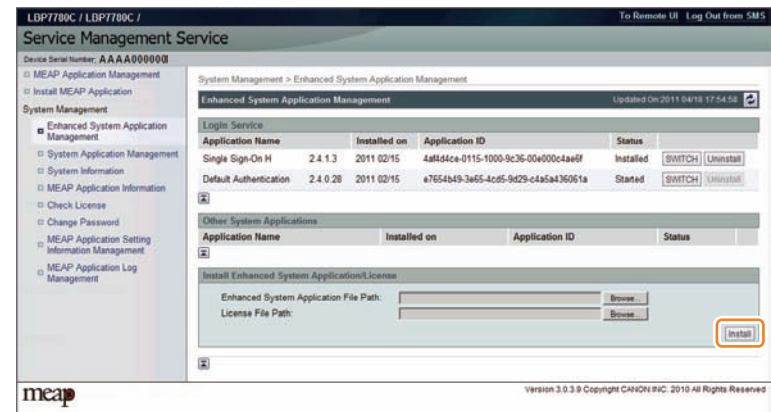

F-2-126

Procedure Uninstalling Login Services

Use the following procedure to uninstall the login services.

Also, note that the services need to be stopped ("Installed" status) in order to uninstall the login services.

- 1) Access SMS, and then select [System Management] > [Enhanced System Application Management].

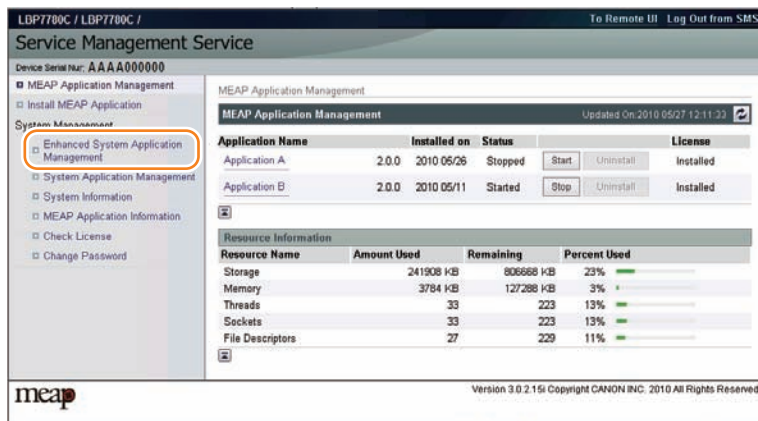

F-2-127

- 2) Click the [Uninstall] button of the login service you want to uninstall.

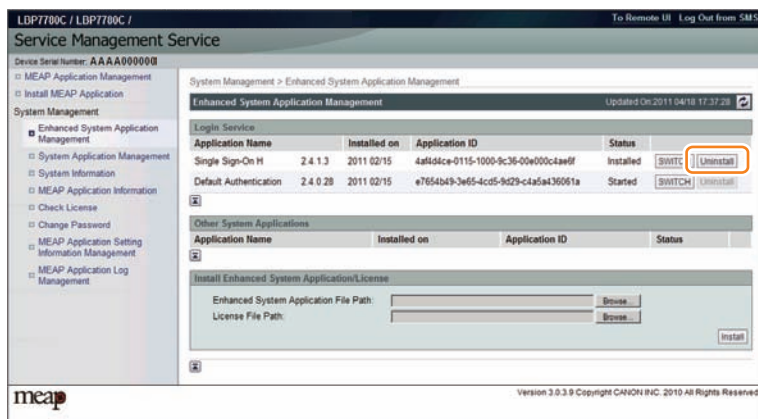

F-2-128

System Application Management

This function manages the login services for logging in to SMS.

Procedure to manage System Application

Use the following procedure to manage the System Application.

- 1) Access SMS, and then click [System Management] > [System Application Management].
- 2) Click [Start] or [Stop] button in the status column of the system application that wants to start or stops.

System Management > System Application Management



F-2-129

- 3) Log out of SMS. (When you log in next time, a set content becomes effective.)

System Information

Outline

You can check the device's platform information and the MEAP application's system information.

Checking the System Information

System information that can be checked from the screen:

- Platform information
 - MEAP Specifications version (MEAP Spec Ver)
 - MEAP Contents version
 - Java Virtual Machine version
- System application information
 - The name of the installed system application
 - The installation date of the installed system application
 - Application ID of the installed system application
 - The status of the installed system application

The checking procedure is shown below.

- 1) Log in to SMS.
- 2) On System Management menu, click [System Information] button.

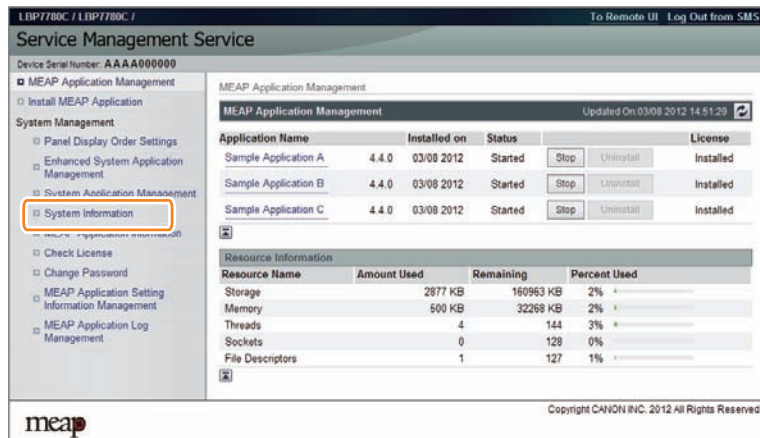

F-2-130

Display of System Information Details

The system information details can be displayed to check more than one pieces of information all at the same time: platform information, system application information, information on the installed MEAP applications, etc.

- 1) Log in to SMS.
- 2) On System Management menu, click [System Information].
- 3) Click [Display Details] button.

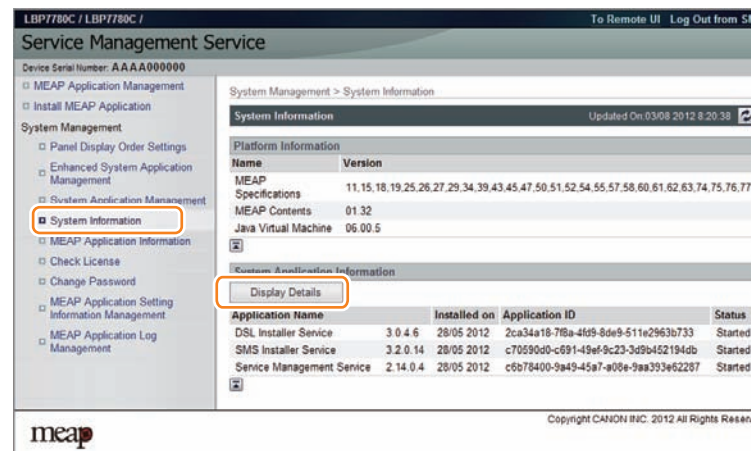

F-2-131

- 4) The system information of each application (including System Application) is shown in a separate window. Copy and paste all the information in a file to attach to AR reports as text information. This function is useful to check status information of each application.



F-2-132

Printing the System Information of a MEAP Application

MEAP system information can be printed out with iR device for confirmation.

Note:
The system information of the MEAP application that you checked in the previous section is exactly the same as the system information of the MEAP application that is output.

Follow the steps below when confirming information:

- 1) From [Utility Menu], select [Print MEAP Sys. Info].
- 2) When the execution confirmation screen appears, select [Yes] and then press the [OK] button on the Control Panel.

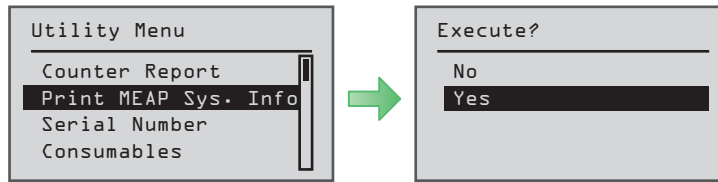

F-2-133

Content of MEAP system information

Application System Information

```
Application Name: C-Cabinet Gateway for MEAP
Application ID/System Application Name: 03a46668-63e4-4636-9cbb-492b6cef05d5
Application Version: 1.0.0
Status: Resolved
Installed on: Tue Oct 21 14:00:11 GMT+09:00 2003
Vendor : Canon Inc.
License Status : Installed
Maximum Memory Usage : 1024
Registered Service :
```

Item	Content
Status	It indicates the status of the application in question; specifically, Installed: the application has been installed. Active: the application is being in use. Resolved: the application is at rest.
Installed On	It indicates the date on which the application was installed.
Vendor	It is the name of the vendor that developed the application, and is the name (bundle-vendor) declared in a statement within the application program.
License Status	It indicates the status of the license; specifically, None: no license is needed. Not Installed: no license has been installed. Installed: the appropriate license has been installed. Invalid: the license has been invalidated. Overlimt: the license has been used beyond its permitted limit.
License Expires After	It indicates the date after which the license expires. If the status of the license is 'none', this item will not be printed.
License Upper Limit	It indicates the limit imposed on individual counter readings. If the status of the license is 'none', this item will not be printed.
Counter Value	It is the current counter reading of a specific counter. If the status of the license is 'none', this item will not be printed.
Maximum Memory Usage	It indicates the maximum amount of memory that the application uses. It is the amount (maximum memory usage) declared in a statement within the application program, and is expressed in kilobytes.
Registered Service	It is a list of services that have been registered by the application with the MEAP framework. Some services may not have printable data.

T-2-17

Item	Content
Application Name	It is the name (bundle-name) declared in a statement within the application program. It may not necessarily be identical to the name of the program.
Application ID/System Application Name	Application ID (application-id) items which are declared on the declaration statement in the application program are printed.
Application Version	It is the version of the application (bundle-version) declared in a statement within the application program.

MEAP Application Information

Outline

You can use this function to check the MEAP application installed on the device.
The following information can be checked on the MEAP application information screen.

- Application Name
- Application ID
- Installed on
- Status
- License Status
- Counter Information

Procedure to Check MEAP Application Information

- 1) Log in to SMS.
- 2) On System Management menu, click [MEAP Application Information] button.

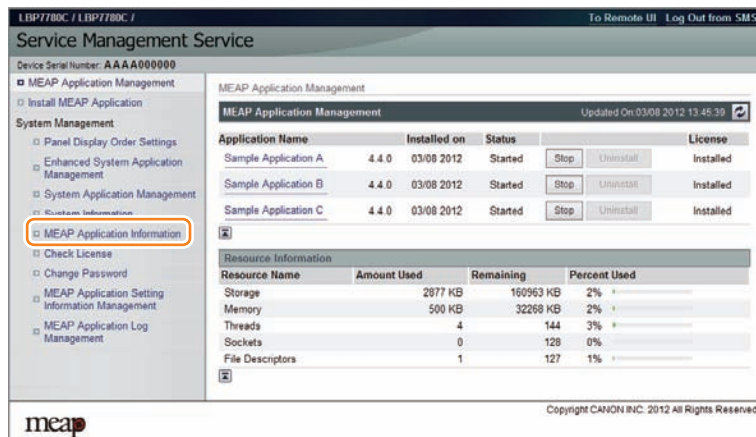

F-2-134

- 3) The MEAP application information screen appears.

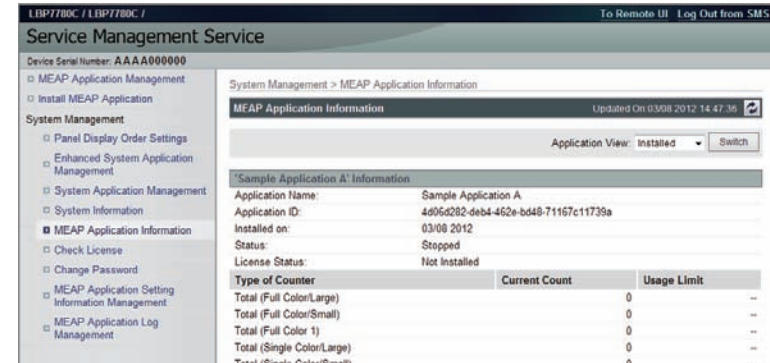

F-2-135

Check License

Outline

You can use this function to check the contents of the license file.

Procedure to Check the License File

- 1) Log in to SMS.
- 2) On System Management menu, click [Check License] button.

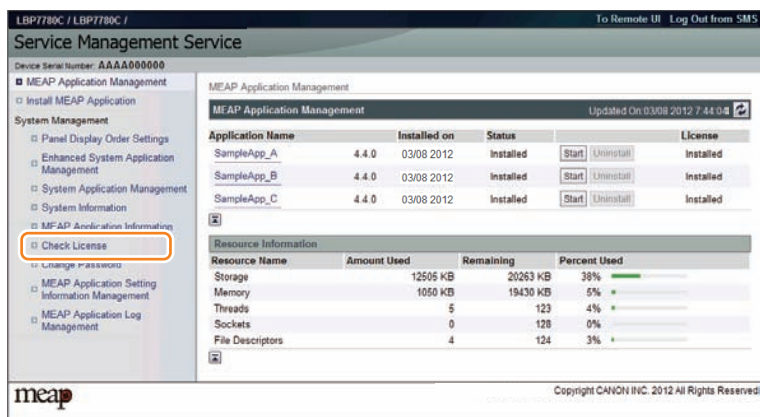

F-2-136

- 3) Click the [Browse..] button, specify a license file, and click the [Check] button.

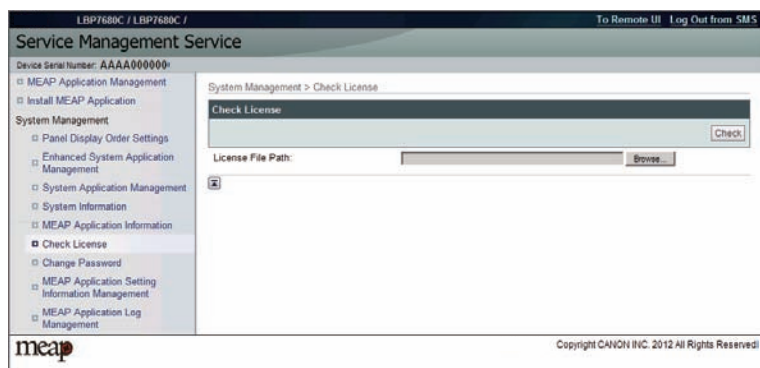

F-2-137

Changing SMS Login Password

Outline

You can change the password for logging in to SMS.

If you forgot the login password and you want to change the password back to the default value (MeapSmsLogin), see "When SMS Cannot Be Accessed" in this manual.

Procedure to Change the SMS Login Password

- 1) Log in to SMS.
- 2) On System Management menu, click [Change Password] button.

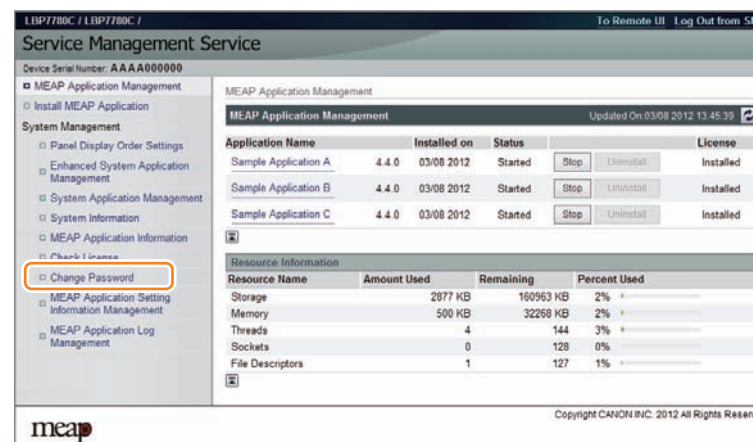

F-2-138

- 3) Enter both the current password and a new password, and then click the [Change] button.

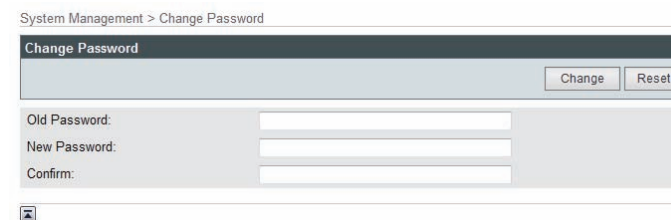

F-2-139

Note:

The [Reset] button on the [Change Password] screen is used to clear the value entered in the text field. It is not a button for changing the SMS login password back to the default value.

MEAP Application Setting Information Management and Log Management

Outline

The MEAP Application Setting Information Management page and the MEAP Application Log Management page provide menu related to "MEAP Application Configuration Service" for managing MEAP application setting information and "MEAP Application Log Service" for managing log information respectively.

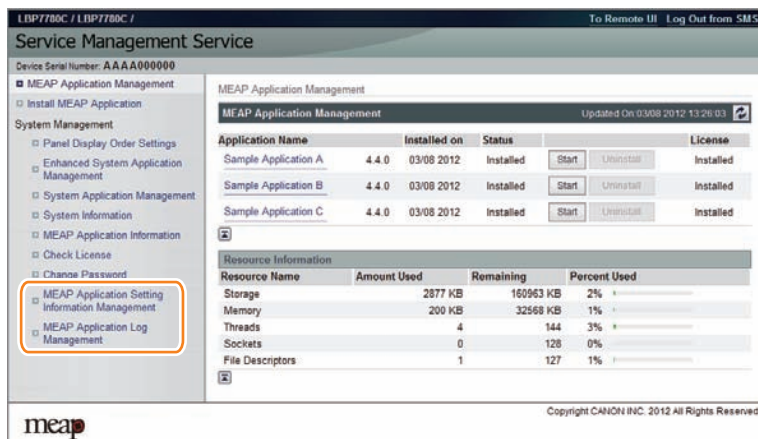

F-2-140

MEAP Application Configuration Service

This service manages the MEAP application setting information. It has functions such as saving setting information to the MEAP area. Ver 57 of MEAP Specifications supports this service.

MEAP Application Log Service

This service is used to collect MEAP application logs (debug logs and authentication logs). Ver.58 of MEAP Specifications supports this service.

Advantages Obtained When Using the Services

By using MEAP Application Configuration Service and MEAP Application Log Service, as long as the MEAP application supports these services, you can perform data management tasks all together.

In case of devices and MEAP application that do not support the service

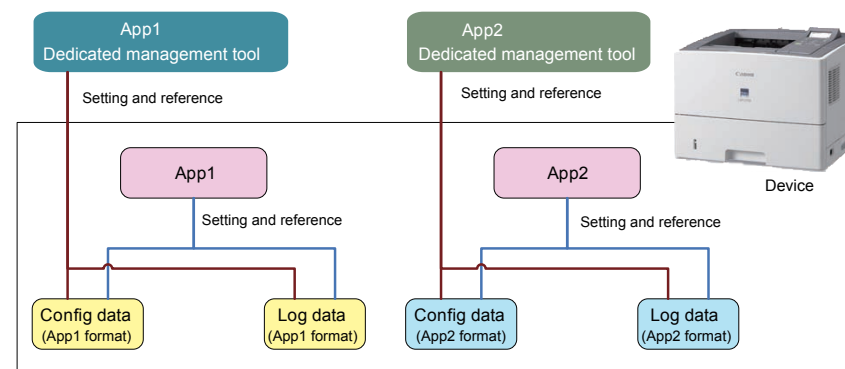

F-2-141

As for devices and MEAP application that do not support the service, the setting information and log data are managed separately by application.

In case of devices and MEAP application that support the service

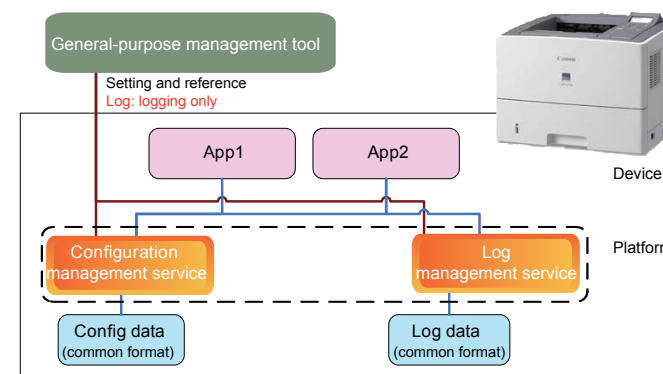

F-2-142

As for devices and MEAP application that support the service, information can be managed all together.

MEAP Application Setting Information Management

The setting data (stored on the device) of the MEAP application which supports the Configuration Service can be deleted. The procedure is shown below.

- 1) Log in to SMS.
- 2) On System Management menu, click [MEAP Application Setting Information Management] button.

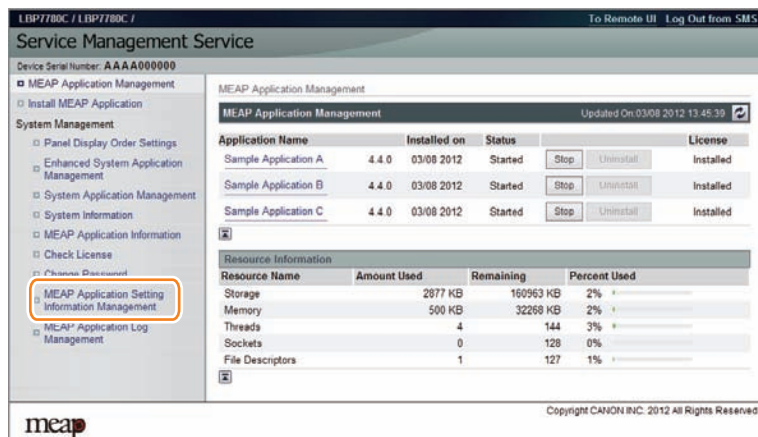

F-2-143

- 3) Select an application you want to delete, and then click the [Delete] button.

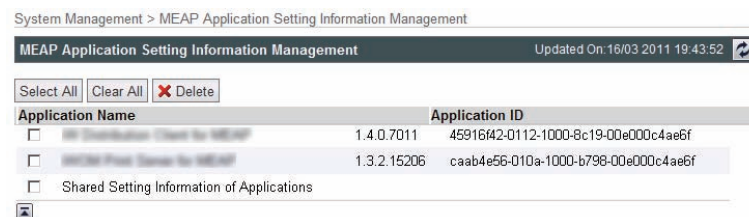

F-2-144

Note:

If the installed MEAP application contains setting data which is not dedicated to the application but can be shared, the application name [Shared Setting Information of Applications] will be displayed.

MEAP Application Log Management

The log data (stored on the device) of the MEAP application which supports the Log Service can be downloaded or deleted. The procedure is shown below.

- 1) Log in to SMS.
- 2) On System Management menu, click [MEAP Application Log Management] button.

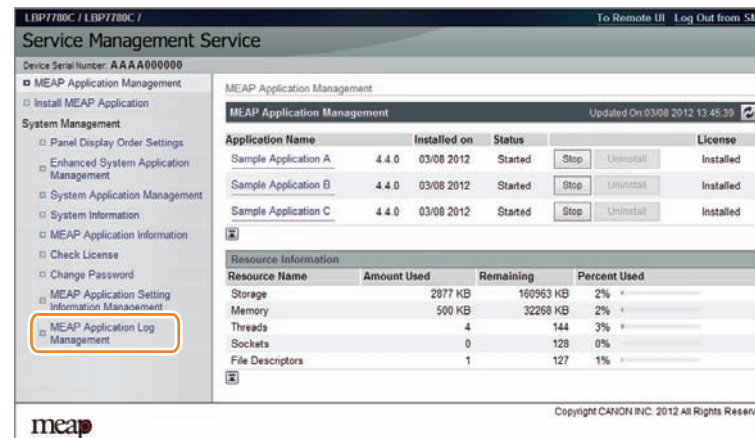

F-2-145

- 3) Click [Download Application Logs] or [Delete Application Logs].

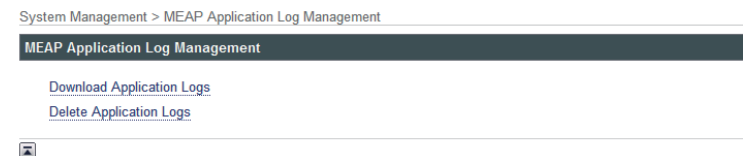

F-2-146

- 4) To download the log

The file save dialog for the log file will appear. Specify a destination and save the file.

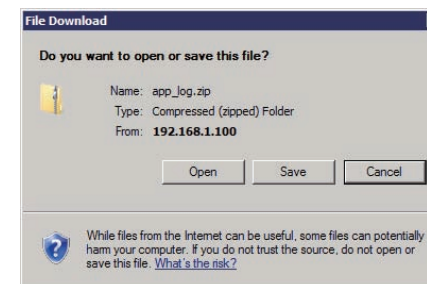

F-2-147

5) To delete the log

The confirmation screen will appear to prompt you to delete the log. Click the [Yes] button to delete the log.

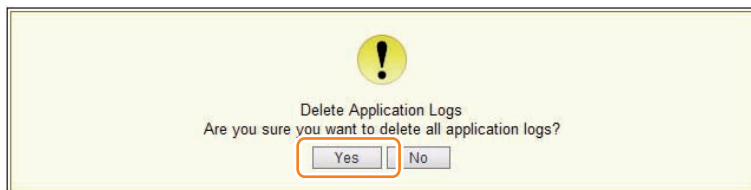

F-2-148

Maintenance

When Replacing the PCB

Outline

If the machine fails to operate normally due to a storage drive (Flash PCB) failure or a system (other than MEAP application) trouble, the storage drive needs to be replaced.

However, since the storage drive in this machine is directly mounted on to the PCB, replacement of the part alone is not possible; it is necessary to replace the PCB.

Since the storage drive of the machine cannot be backed up or restored, the MEAP application and the license file need to be reinstalled when replacing the PCB.

When the storage drive and the system are operating normally but the PCB is replaced due to other reasons, the MEAP application and license file need to be reinstalled.

The MEAP counter information cannot be lost because it is backed up like other conventional counters.

Note:

When the device has E code 616 displayed, this indicates that the trouble was caused by damage to the Flash PCB. If this error occurs, the PCB needs to be replaced.

Special license for reinstallation

When replacing the PCB, a special license file is required to reinstall the application with the expiration date of the current counter value migrated as it is. This special license file is handled as a service tool and cannot be obtained by end users.

In order to obtain a special license file, the service technician needs to contact the person in charge of support at the sales company.

The service technician needs to give the device serial number and the names of the MEAP applications that had been installed.

Since the support department of the sales company manages all the issued application license files by device serial number, it is basically possible for them to successively issue license files once the device serial number is confirmed.

Note:

The application that is installed with a reusable license can be reinstalled by using the same license.

● Procedure for reinstalling MEAP applications after replacing the PCB

The following shows the procedure when replacing the PCB.

1)Preparation before replacement

The following work needs to be done before replacing the PCB.

- Some MEAP applications have a function to back up or export the data to be used. If such a MEAP application is installed, back up or export the data in advance.
- In order to reinstall the applications, copy the licenses (special licenses, reusable licenses, etc.) of all the MEAP applications to the laptop PC.

2)Replacing the drive

Prepare the necessary service parts, and replace the drive.

3)Reinstalling the MEAP application

When the device has started normally, obtain the jar files of the MEAP applications from the user, and install them using the license files for reinstallation.

Installation method is the same as normal installation.

4)Importing user information

As necessary, make login service selections and import user information.

Note:

When you replace the PCB without uninstalling MEAP applications, make sure to reinstall the previously installed applications. Unless reinstalling them, MEAP counter will not be released and the message "The number of applications that can be installed has exceeded the limit. Try to install this application after uninstalling other applications." is displayed so that the installation of new applications may not be accepted. If you want to install new applications in this case, once reinstall the applications in-stalled before formatting and uninstall unnecessary applications.

WARNING:

- Do not install a Main PCB of another device and conduct operation check in order to check whether an error has occurred in the Main PCB. If the PCB is replaced and the system is started, the data on the installed PCB will be initialized.
- If an application was installed using a license other than reusable licenses and then installed using a special license for reinstallation, the moved MEAP counter information is migrated to the application.
- If the serial number is changed due to device replacement, a transfer license needs to be obtained and installed by a service technician as is the case with iR devices.

■ Actions to be taken when E616 is displayed.

● Overview

When E602 is displayed and then the device is restarted as a remedy, E616 may be displayed in some cases.

This is a symptom that occurs when the power is cut off without shutdown (such as disconnecting the plug of the device). The error code is displayed when the file system of the MEAP storage area is in an abnormal status.

When the device is started, it checks the file system. If the device detects an error, it displays the error code E602, disables the MEAP function, and then starts.

When the device is restarted according to the remedy for E602, the file system is recovered automatically in the system. If the recovery procedure succeeds, the device starts normally with the MEAP function enabled.

However, if the file system could not be recovered by auto recovery, E616 is displayed.

Since the system is automatically formatted when E616 is displayed, the installed MEAP applications will disappear and the device's MEAP function itself will also be disabled.

For this reason, it is necessary to enable the MEAP function and then reinstall the MEAP applications.

● Work procedure

Perform the following procedure when E616 is displayed.

- 1)Start the device in service mode.
- 2)Select [Setup] > [SERVICE MODE] > [FUNCTION GR.] > [MEAP FUNCTION] > On to enable the MEAP function.
- 3)Restart the device to start the MEAP function.
- 4)Access SMS, and then use a reusable license or special license for reinstallation to install the MEAP application.

Note:

As for MEAP applications that were installed using reusable licenses, the reusable licenses can be used to reinstall the applications. For other MEAP applications without reusable licenses, use special license files to reinstall them, in the same as way as handling a storage drive failure.

For information on how to obtain a special license for reinstallation, see "Special license for reinstallation" in this chapter. Then contact the support department of the sales company to have the license issued before starting the work.

- 5)Start the MEAP application.

MEAP Safe Mode

Outline

Use safe mode if you need to start up the system without worrying about extra applications. It will start up only those system software files (including SMS) that normally start up as default files while preventing MEAP applications and the like from starting up.

When you have made changes and restart the device, the control panel will indicate 'MPSF' in its lower right corner. The MEAP applications that may have been active before you shut down the equipment will not start up on their own. Make use of safe mode when restoring the system software as when MEAP applications or services cause a fault as the result of a conflict or wrong sequence of registration/use. You can access to SMS in this condition so that you can take necessary measures, for example, you can stop application that may cause the trouble.

If default authentication has been selected, the mode of authentication remains valid; otherwise, the message "The login service must be set again with SMS" appears. Change the login service as necessary.

Starting in Safe Mode

To start the device in the MEAP SAFE mode, turn ON the power with the [Application] key and the [ID] key pressed.

How to cancel MEAP SAFE mode

If you want to cancel MEAP SAFE mode, just restart the device as usual. It will start in normal mode.

Note:

If accessed to SMS in MEAP SAFE mode, the device started mode is shown on the title bar of the browser.

When normally started:

Service Management Service : <Device Name>: <Product Name>

When starting in MEAP SAFE mode:

Service Management Service : <Device Name>:<Product Name>: Safe Mode

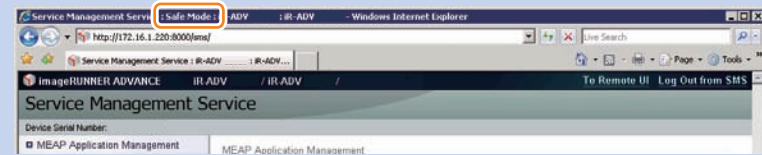

F-2-149

WARNING :

If the device has been started in the MEAP SAFE mode, all MEAP applications stop and the status becomes "Installed".

This status remains unchanged even if the MEAP SAFE mode is cancelled and the device is started again in normal mode. It is therefore necessary to access SMS after normal startup, and start the MEAP application.

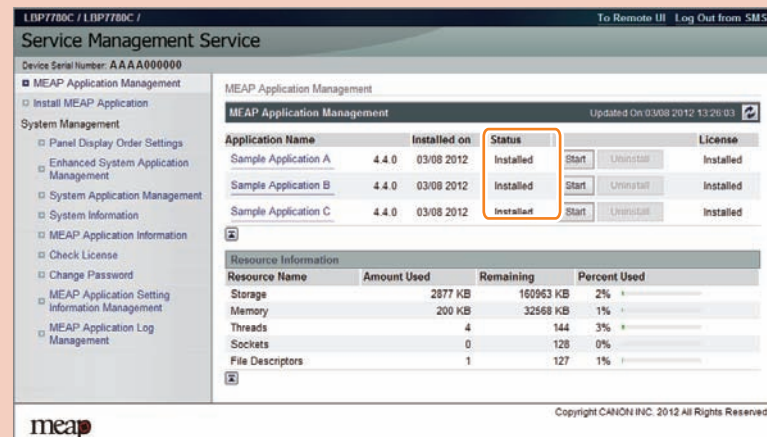

F-2-150

Using USB Devices

Two types of USB drivers

While the USB driver that can be used in iR series is only the USB driver designed exclusively for MEAP application (hereinafter referred to as “MEAP driver”), not only MEAP driver but also USB system driver (hereinafter referred to as “system driver”) can be used in iR-ADV series.

System driver and MEAP driver cannot be used together. When either of them is used, the other driver cannot be used.

In this model, the USB system driver supports only Mass Storage; HID is not supported. In other words, storage devices such as USB Flash memory can be used via system driver, but interface devices such as USB keyboard cannot be used via system driver.

USB driver setting

System driver is active by default in iR-ADV series.

The driver can be changed in setup menu.

Usually, It is not necessary to change the setting because it is specified in the MEAP application side.

Only in the case of a special MEAP application, it is necessary to change the USB driver setting.

For details, refer to specifications of MEAP application side.

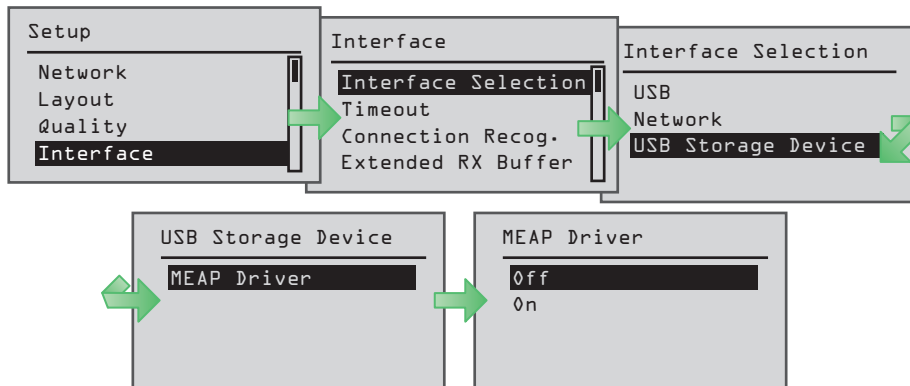

F-2-151

USB Storage Device Settings: [MEAP Driver]	Application that supports mass storage device	MEAP application that supports system driver
OFF (*default)	Cannot use USB mass storage device. (Device cannot be detected.)	Can use USB mass storage device.
* Native driver		

T-2-18

Note:
When any settings changes are made, the device must be restarted.

USB Storage Device Settings: [MEAP Driver]	Application that supports mass storage device	MEAP application that supports system driver
ON * MEAP driver (compatibility mode)	Can use USB mass storage device. Can work only on the applications that support the MEAP application driver.	Cannot use USB mass storage device.

● Setting the USB driver for each USB device (MEAP driver preference registration)

If it is set to use the system driver, the conventional applications that support the MEAP application driver cannot use the USB input device.

Therefore, for the USB drivers used by USB devices/MEAP applications, there is setting function (MEAP driver preference registration) to give priority to the MEAP driver.

If you register the ID of the USB device by using this function, the USB device can use the MEAP driver despite the Additional Function settings.

Using this function requires the conditions below:

- Supported MEAP Spec Ver: 26
- Describe the idVendor(VID) and idProduct(PID) of USB device in the manifest or activate/deactivate the VID and PID by calling API from MEAP applications.

The driver setting that is used in a manifest file is reflected in the following timing.

When registering from a manifest file.

- The registration will be enabled when an application is activated and device is restarted.
- The registration will be disabled when an application is stopped and device is restarted.

Availability for MEAP application of the USB device A (either HID keyboard or Mass Storage) plugged to iR device

Registration status of USB device A	USB Setting [Use MEAP driver for USB input device]	Native application	MEAP application		
			System driver supported application	System driver not supported/ conventional application	Application with VID/PID declared in Manifest for x
Not registered	OFF	YES	YES	NO	
	ON	NO	NO	YES	
Registered	OFF	NO	NO	YES	YES
	ON	NO	NO	YES	YES

YES: USB device available

NO: USB device not available

T-2-19

● Reference material

■ Glossary

Terms & Acronyms	Definitions and Explanations
Application	A program unit to provide users with solutions.
Application ID	An identifier assigned to each application. A unique ID is assigned to each MEAP application.
Applet (Applet Type Application)	A MEAP application type created in Java. This type of applications show buttons on the touch panel display.
Code Sign	Information to check if an application is genuine. An application marketed in the normal procedure has a code sign assigned by LMS. MEAP platform rejects applications without Canon code signs for being installed or executed on the device.
CPCA (Common Peripheral Controlling Architecture)	Common Peripheral Controlling Architecture. CPCA defines an object model of peripheral devices. A client can control a device by creating or modifying objects in the device.
CPCA Java CL (Class Library)	CPCA Java Class Library. A Java class library, which is used to control a device.
Default Authentication -Department ID Management	Default Authentication is a pre-installed login application that runs by default. It provides authentication functions to allow minimum operation of the Controller System, even when no other login application is running.
Device Specification ID	ID allocated to each device type. This represents CPCA API specification and the version number to use the device generic functions or obtain information including maximum allowable copies.
Esplet (Esplet Type Application)	A MEAP application type created in Java. This type of applications do not show user interfaces either on Local UI or Web. Esplet is a coined word created by Canon, consisting of [Espresso] or Italian coffee and [let] derived from Applet/Service.
File Description	An identifier for the OS to identify the destination file requested by a program. A program descriptor includes an identifier and information such as a file name and size, which helps OS to judge the file to be edited.
HID class	HID stands for Human Interface Device, representing man-machine interfaces of PC components and peripheral devices. HID class means USB class classified as HID.
iR Native application	The functionalities that existing iR has such as Copy, Universal Send and Mailbox.
ISV (Independent Software Vendor)	Independent Software Vendor. Software manufacturer who develops and/or sells applications and tools but does not entire computer systems. Refers application developer in this document.
J2ME (Java2 Platform Micro Edition)	Java 2 Platform Micro Edition. One of Java Platforms licensed by Sun Microsystems, Inc. It is applied for MEAP. Other devices such as cellular phones and PDA.

Terms & Acronyms	Definitions and Explanations
J2RE (Java 2 Runtime Environment)	A set of basic programs to run applications developed in the programming language of Java2. This set includes Java virtual machine providing runtime environment for Java applications among others. Java applets do not require J2RE since these are executed on Web browsers using Java runtime environment provided on browsers. However, standalone Java applications require Java runtime environment such as J2RE for execution. Runtime environments can be downloaded for free of charge from the Web site of Sun Microsystems, the Java developer.
Java	A programming language developed by Sun Microsystems, in the U. S. A. Low dependent on models and Oses and runs on various platforms. Taking advantage of this feature, many applications that runs on web servers uses Java. The MEAP platform uses J2ME - a type of Java.
JavaScript	A script language developed by Netscape Communications, in the U.S. A., runs on web browsers such as Netscape Navigator and Internet Explorer. Allows web designers to create interactive pages with HTML files such as animated buttons and display of timetables.
Java VM (Java Virtual Machine)	JAVA Virtual Machine. The Java byte code interpreter. The Virtual Machine acts as an interpreter for processing the byte code using the native instruction set.
License Access Number	A number issued for accessing license file. The Licensing server requires entries of application ID, expiration date/times information, and the number of access numbers, to issue license access numbers
License File	A software manufacture of a MEAP application provides the users with the license files. Specifies the terms of agreement that a user concludes with the manufacturer. Required for installing a MEAP application.
LMS (License Management System)	The license is required for installing a MEAP application in a MEAP-enabled iR device. LMS is the server issuing [License Files] as well as license access numbers.
Login Service	Manages user information of MEAP device. Authenticates users with user names and passwords. Three login services are available for MEAP device - Default Authentication, which provides department ID control, SDL (Simple Device Login) and SSO (Single Sign-On).
Mass Storage class	Mass Storage means a storage device with large capacity, generally secondary storage devices. Mass Storage class means USB class classified in the secondary storage device group.
MEAP (Multifunction Embedded Application Platform)	Multifunctional Embedded Application Platform. Provides an environment for executing application programs on a peripheral device. Uses the Java platform (J2ME - Java 2 platform Micro Edition) to run Java application for MEAP.
MEAP Contents	Required to install an MEAP application to a MEAP device.

Terms & Acronyms	Definitions and Explanations
MEAP Specifications (MEAP Spec Version)	MEAP Spec Version, the term used for the SDK. The version number that shows the APIs of the MEAP platform other than CPCA, such as network and security. The version number is not assigned for each device model. MEAP Application Runs on MEAP platform. Consists of application files (*.jar) and the license file (*.lic).
MEAP-enabled iR device	iR devices with built-in MEAP platform.
MFP (Multi Function Peripheral)	Multi Function Peripheral. Peripheral device that supports more than one function, such as digital copier, printer, scanner, and fax.
OSGi (Open Service Gateway Initiative)	Open Service Gateway Initiative. See " http://www.osgi.org/ ".
Portal Service	The web portal to gain access to a MEAP-enabled device. This service has been integrated in Remote UI top page in iR ADVANCE series.
Protocol	A set of rules applied to data transmission procedures over network. Major communication protocols include: <ul style="list-style-type: none"> • FTP: File Transfer Protocol. This is a communication protocol or protocol-implemented commands to provide file transfer between a host and clients over TCP/IP network. • DHCP: An upward compatible protocol of BOOTP. This communication protocol allocates a dynamic IP address to each client machine upon communication startup on TCP/IP network and collects the allocated IP address when communication is completed. The server allocates one of multiple IP addresses and notifies the setup information to a client. • BOOTP: A communication protocol to automatically load setup information including IP address and a domain name from the server to a client on TCP/IP network. • RARP: A communication protocol to request IP address information via the network adaptor address (MAC address) of a client. • IPP: A communication protocol to execute remote printing between the print server and clients via Internet. • TCP/IP: A standard communication protocol required to access to Internet and other large-scale network.
Proxy Server	Provides functions to store data fetched from remote servers. When a user request to display a web page that has been displayed and stored in the proxy, the proxy server reads the stored data but does not access the remote server where the original page is present, for efficient access services. When a proxy server receives a URL from a PC, it searches the file in the cache and sends it to the PC if the requested file is found. If the requested file is not stored in the cache, it accesses the remote server of the URL to acquire the file and, at the same time, stores the acquired file in the cache so that the proxy server can quickly send the file at the next request.
Redistribution module	A built-in module of an application created with SDK. Applications without this module cannot work on MEAP platform.

Embedded RDS

Product Overview

Overview

Embedded RDS (hereinafter referred to as E-RDS) is a monitoring program that runs on the host machine. When the monitoring option is enabled by making the setting on this machine, information such as the status change of the machine, counter information, and failure information are collected. The collected device information is sent to a remote maintenance server called UGW (Universal Gateway Server) via Internet, thus allowing for e-Maintenance/imageWARE Remote (Remote Diagnosis System).

The following device information/ status can be monitored.

- Billing counter
- Parts counter
- Firmware info
- Service call error log
- Jam log
- Alarm log
- Status changes (Toner low/ out, etc.)

Since high confidentiality is required for the information shown above, it performs communication between this machine and the UGW using HTTPS/ SOAP protocol.

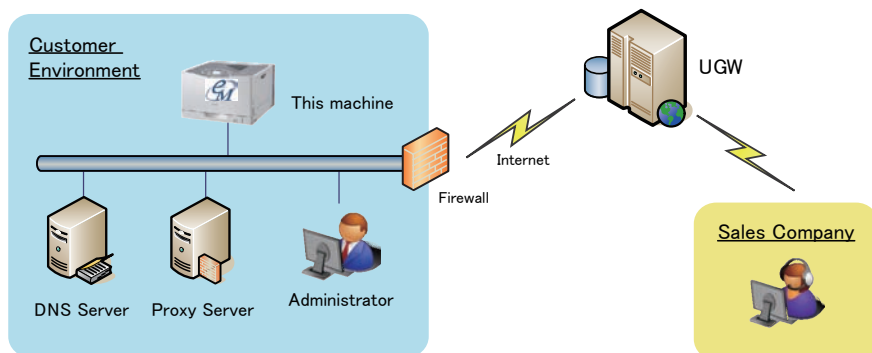

The e-Maintenance/ imageWARE Remote system configuration

F-2-152

Features and benefits

E-RDS embedded with a network module in advance can realize a front-end processing of e-Maintenance/ imageWARE Remote system without attaching any extra hardware equipment.

Service cautions

- 1) After clearing RAM of the Main Controller, initialization of the E-RDS setting (CLEAR), E-RDS settings (E-RDS SWITCH : ON) and a communication test (COM-TEST) need to be performed.
Failure to do so will result that the counter transmitting value to the UGW may become unusual.
Also, after replacing the main controller board, all settings must be reprogrammed.
- 2) The following settings in service mode must not be change unless there are specific instructions to do so. Changing these values will cause error in communication with UGW.
 - Set port number of UGW
[SERVICE MODE] > [NETWORK GR.] > [E-RDS] > [RGW-PORT]
Default : 443
 - URL setting of UGW
[SERVICE MODE] > [NETWORK GR.] > [E-RDS] > [RGW-ADDRESS]
Default : https://a01.ugwdevice.net/ugw/agentif010
- 3) If the e-Maintenance/imageWARE Remote contract of the device is invalid, be sure to turn OFF the E-RDS setting (E-RDS SWITCH).

4) Communication tests can be conducted in user mode.* When conducting a communication test in user mode, pay attention on the following points:

- During a communication test in user mode, do not take any actions such as pressing a key. Actions are not accepted until the communication test is completed (actions are ignored).
- When a communication test is being conducted from service mode or user mode, do not conduct a communication test from the other. These operations are not guaranteed.

NOTE:

*The user can conduct a communication test and see the communication test result. If the communication results in failure, an error code (a hexadecimal number, 8 digits) appears in the communication log.

Monitoring Service	Comm. Log
Comm. Test	1 CODE : 810f200b
Comm. Log	2 CODE : 840f0003
	3 CODE : 840f0003
	4 CODE : 840f0003

5) In the case of devices whose power is OFF at night, data such as billing counter values cannot be sent to UGW. Data that could not be sent will be sent to UGW when the power is turned ON.

If thousands of devices are started first thing in the morning and data is sent from all of them simultaneously, it may result in a network failure.

It is possible to reduce the amount of E-RDS data sent at power ON and avoid occupying the network bandwidth by changing the following service mode to ON.

```
[SERVICE MODE] > [NETWORK GR.] > [E-RDS] > [REDUCE SEND METHOD]
Default: OFF
```

NOTE:

When the following service mode is ON, data such as billing counter values is not sent. Errors (service calls, alarms, and jam logs) and debug logs (when the data size reaches a specified value) are sent.

E-RDS Setup

Confirmation and preparation in advance

To monitor this machine with e-Maintenance/ imageWARE Remote, the following settings are required.

(1) Advance confirmation

Confirm with the UGW administrator that the device to be monitored with e-Maintenance/ imageWARE Remote is registered in the UGW.

(2) Advance preparations

The following network-related information needs to be obtained from the user's system administrator in advance.

Information item 1

IP address settings

- Automatic setting : DHCP, RARP, BOOTP (ON/ OFF selection)
- Manual setting : IP address, subnet mask and gateway address to be set

Information item 2

Is there a DNS server in use?

If there is a DNS server in use, find out the following.

- Primary DNS server address
- Secondary DNS server address

Information item 3

Is there a proxy server?

If there is a proxy server in use, find out the following.

- Proxy server address
- Port No. for proxy server

Information item 4

Is proxy server authentication required?

If proxy server authentication is required, find out the following.

- User name and password required for proxy authentication

(3) Network settings

Based on the results of the information obtained in (2) Advance preparations, make this machine network related settings.

See Users' Guide for detailed procedures.

CAUTION:

Ensure to reboot this machine when any change is added to the network setting.

Steps to E-RDS settings

1. Start [Service Mode].
2. Select [NETWORK GR.] and press [OK] or [▶] button to go to the network setting menu.

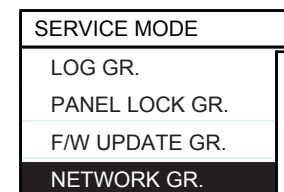

F-2-153

3. Select [E-RDS] and press [OK] or [▶] button to go to E-RDS setting menu.

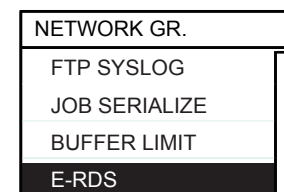

F-2-154

4. Select [CLEAR] and press [OK] or [▶] button to display Confirm Initialization screen. Select [Yes] and press [OK] button.

NOTE:

This operation initializes the E-RDS settings to factory setting values. For the setting values to be initialized, see the section of "Initializing E-RDS settings".

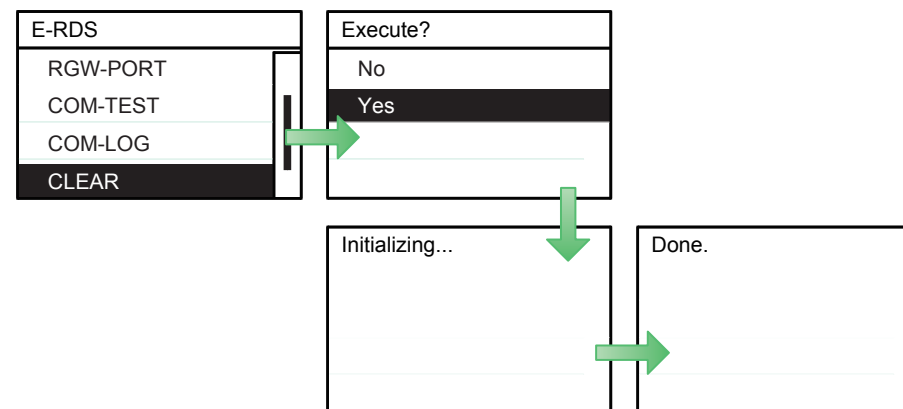

F-2-155

5. Perform installation or deletion of the CA certificate if necessary, and reboot this machine.
- Installation of the CA certificate: Perform installation from Remote UI.
 - Deletion of the CA certificate: When the following operation is performed, the CA certificate in the factory setting is automatically installed.

CAUTION:

After following procedure, the registered key and CA certificate are deleted, and only the CA certificate installed at the time of shipment is registered.
It is therefore necessary to check with the user in advance.

- 1) Select [NETWORK GR.] > [CA-KEY] > [CLEAR] and press [OK] or [▶] button to display Confirm Clear screen. Select [Yes] and press [OK] button.

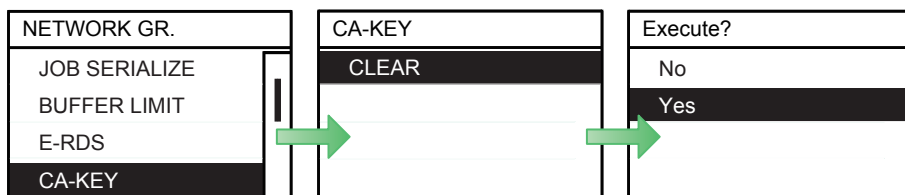

F-2-156

- 2) Reboot this machine.

CAUTION:

If a key and a CA certificate have been registered in order to use a function other than E-RDS, it is necessary to register again from Remote UI.

6. Activate [SERVICE MODE].

7. Select [NETWORK GR.] > [E-RDS] > [E-RDS SWITCH] and press [OK] or [▶] button.

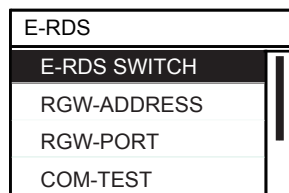

F-2-157

8. Select [On] and press [OK] button.

NOTE:

This operation enables the communication function with UGW.

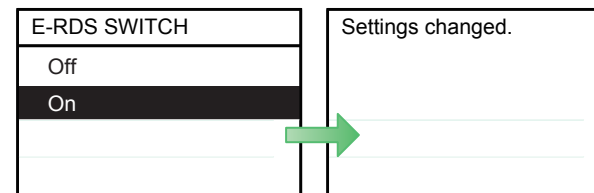

F-2-158

9. Go back to E-RDS Setup menu.

CAUTION:

The following settings i.e. RGW-PORT and RGW-ADDRESS in Service mode must not be change unless there are specific instructions to do so.

Changing these values will cause error in communication with UGW.

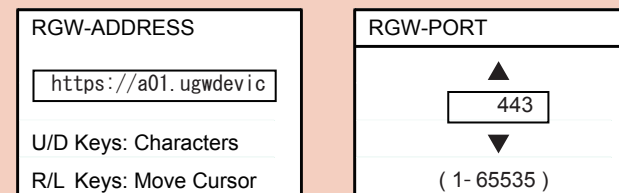

10. Select [COM-TEST] and press [OK] or [▶] button to display Confirm Communication Test screen. Select [Yes] and press [OK] button.

NOTE:

This initiates the communication test between the device and the UGW.

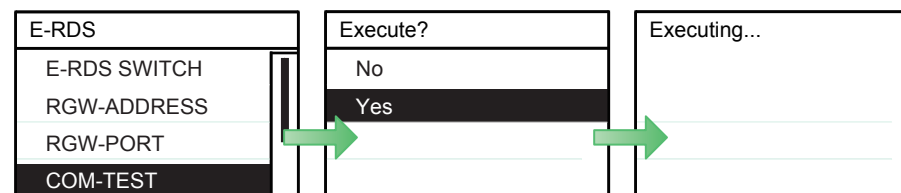

F-2-159

If the communication is successful, "Done." is displayed. If "Could not execute." (failed) appears, refer to the "Troubleshooting" and repeat until "Done." is displayed.

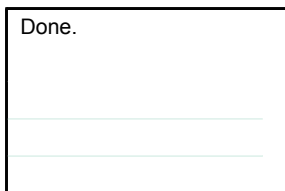

F-2-160

NOTE:

The communication results with UGW can be distinguished by referring to the communication log. By performing the communication test with UGW, E-RDS acquires schedule information and starts monitoring and meter reads operation.

■ Initializing E-RDS settings

It is possible to return E-RDS Settings to factory-shipments value.

● Setting values and data to be initialized

The following E-RDS settings, internal data, and Alarm filtering information are initialized.

- E-RDS > E-RDS SWITCH
- E-RDS > RGW-ADDRESS
- E-RDS > RGW-PORT
- E-RDS > COM-LOG

CAUTION:

In case of replacing the CA certificate file, even if initialization of E-RDS is executed, the status is not returned to the factory default.

When installing the certificate file other than the factory default CA certificate file, it is required to delete the certificate file after E-RDS initialization and install the factory default CA certificate file.

For detailed procedures, see "Steps to E-RDS settings - step 5.".

● Initialization procedure

1. Start [Service Mode].
2. Select [NETWORK GR.] and press [OK] or [▶] button to go to the network setting menu.

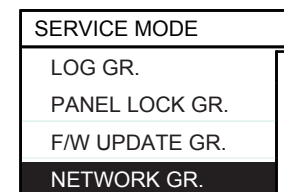

F-2-161

3. Select [E-RDS] and press [OK] or [▶] button to go to E-RDS setting menu.

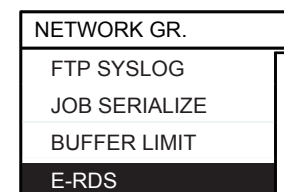

F-2-162

4. Select [CLEAR] and press [OK] or [▶] button to display Confirm Initialization screen.
Select [Yes] and press [OK] button.

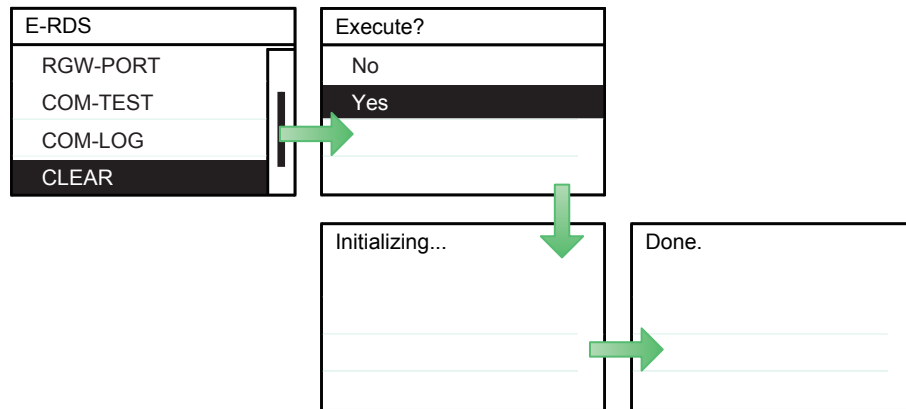

F-2-163

FAQ

No.1

Q: In what case does a communication test with UGW fail?

A: The following cases can be considered in the becoming "Could not execute." case.

1. Name resolution was failed due to an incorrect host name or DNS server has been halted.
2. Network cable is blocked off.
3. Proxy server settings is not correct.

No.2

Q: When does E-RDS send counter information to UGW? How many data is sent?

A: The schedule of data transmitting, the start time are determined by settings in the UGW side. The send time cannot be specified on the E-RDS side. Data is sent once every 16 hours.

The data size of counter information is approx. 285 KB.

No.3

Q: Will data which failed to be sent due to an error in communication with UGW be resent?

A: Data shown below will be resent.

- Jam log
- Service call log
- Alarm log

Data is resent endlessly (after 5, 10, 15, 20, 25, and 30 minutes since the occurrence of communication error; once 30 minutes have passed, it is resent at 30-minute intervals) until it is sent successfully. However, since this machine does not have HDD, data is not resent after turning OFF and then ON the machine.

No.4

Q: What is the upper limit of the number of COM-LOGs? What is the upper limit of the number of characters of error information displayed in a COM-LOG?

A: Up to 5 log data can be saved. The data size of error information is maximum 128 characters.

No.5

Q: Although Microsoft ISA as a proxy server is introduced, the authentication check is failed.

Can E-RDS adopt with Microsoft ISA?

A: E-RDS must comply with "Basic" while "Integrated" authentication is used for Microsoft ISA (as default); therefore, authentication with E-RDS is available if you change the setting to "Basic" authentication on the server.

No.6

Q: Can I turn this machine power off during the e-Maintenance/ imageWARE Remote system operation?

A: While operating the e-Maintenance/ imageWARE Remote system, the power of the device must be ON. If power OFF is needed, do not leave the device power OFF for long time. It will become "Device is busy, try later" errors if the power supply of network equipment such as HUB is made prolonged OFF.

No.7

Q: Although a Service call error may not be notified to UGW, the reason is what?

A: If a service technician in charge turns off the power supply of this machine immediately after error occurred once, It may be unable to notify to UGW because data processing does not take a time from the controller of the device to NIC though, the data will be saved on the RAM.

If the power supply is blocked off while starting up, the data will be inevitably deleted.

No.8

Q: How does E-RDS operate while this machine is placed in the sleep mode?

A: While being in Real Deep Sleep, and if data to be sent is in E-RDS, the system wakes up asleep, then starts to send the data to the UGW. The system also waits for completion of data transmission and let the device to shift to asleep status again.

However, transition time to the Real Deep Sleep depends on the device, and the transition to sleep won't be done if the next data transmission will be done within 1 minute.

No.9

Q: Is E-RDS compatible with Department counter?

A: No, E-RDS does not support Department counter.

No.10

Q: Counter information could not be sent at the scheduled send time due to the power of this machine being turned OFF. Will the counter information be sent later when the power of this machine is turned ON?

A: Yes. When a scheduled send such as that for counter could not be executed due to the power of this machine being turned OFF, etc., and the scheduled send time has already passed at power-on, the send is executed immediately.*

The following shows data send according to the status of this machine.

Send types	Status of this machine		
	Power ON	Power OFF	Sleep
Scheduled send	Sent	Not sent ^{*1}	Sent ^{*2}
Immediate send (Service call log / Alarm log / Jam log)	Sent	-	Sent ^{*2}

T-2-21

*1: Immediately sent if the send time has already passed at power-on.

*2: Sent after recovery from sleep mode.

NOTE:

* If the mode for reducing the amount of E-RDS data sent at power ON and avoiding occupying the network bandwidth (REDUCE SEND METHOD) is OFF, the foregoing behavior is performed.

If the mode is ON, data such as billing counter values is not sent.

Errors (service calls, alarms, and jam logs) and debug logs (when the data size reaches a specified value) are sent.

Troubleshooting

No.1

Symptom: A communication test (COM-TEST) has failed.

Cause: Initial settings or network conditions is incomplete.

Remedy 1: Check and take actions mentioned below.

1) Check network connections

Is the status indicator LED for the HUB port to which this machine is connected ON?

YES: Proceed to Step 2).

NO: Check that the network cable is properly connected.

2) Confirmation from another PC connected to same network.

Request the user to ping this machine from a PC connected to same network.

Does this machine respond?

YES: Proceed to Step 3).

NO: Confirm the details of this machine's IP address and subnet mask settings.

3) Confirm DNS connection

(a) Take a note of both primary and secondary DNS server addresses.

See Users' Guide for detailed procedures.

(b) Use ping command to confirm the primary DNS server IP address against the note taken in Step (a).

See Users' Guide for detailed procedures.

- Is the IP address properly configured?

YES: Proceed to Remedy 2.

NO: Confirm the secondary DNS server IP address against the note taken in Step (a).

- Is the IP address properly configured?

YES: Proceed to Remedy 2.

NO: There is a possibility that the DNS server address is wrong. Reconfirm the address with the user's system administrator.

Remedy 2: Troubleshooting using communication log (COM-LOG)

1) Start [Service Mode].

2) Select [NETWORK GR.] > [E-RDS] > [COM-LOG] and press [OK] or [▶] button to display List Communication Log screen.

E-RDS	COM-LOG
RGW-ADDRESS	1 CODE : 810f200b
RGW-PORT	2 CODE : 840f0003
COM-TEST	3 CODE : 840f0003
COM-LOG	4 CODE : 840f0003

F-2-164

NOTE:

- Only the initial part of error information is displayed in the communication log list screen.
- "None." is shown when nothing is logged.

3) Select the log of your interest and press [OK] or [▶] button to show the date and time of the error occurrence.

COM-LOG
2012 0111 10:17

F-2-165

4) Press [OK] or [▶] button to show the detailed error information.

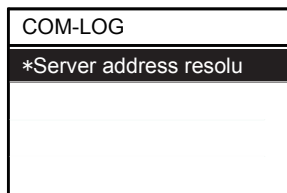

F-2-166

NOTE:

- The detailed error information will be displayed in multiple screens as shown below. Use [◀] or [▶] button to move around the screens.

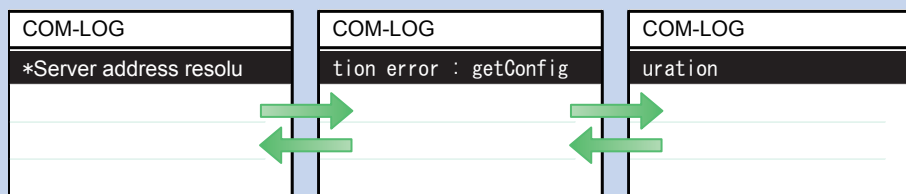

- The data size of error details information is Max 128 characters.
- Press [Back] button to return to Date and Time of Error Occurrence screen.

5) When a message is displayed, take an appropriate action referring to "Error code and strings".

No.2

Symptom: A communication test has failed even if network setting is set properly.

Causes: The network environment is inappropriate, or RGW-ADDRESS or RGW-PORT settings for E-RDS have been changed.

Remedy: The following points should be checked.

- Check network conditions such as proxy server settings and so on.
- Check the E-RDS setting values.
 - Check the communication log from COM-LOG.
 - Check whether RGW-ADDRESS or RGW-PORT settings has changed. If RGW-ADDRESS or RGW-PORT settings has changed, restore initial values. For initial values, see "Service cautions".

No.3

Symptom: There was a log, indicating "Device is not ready, try later" in error details of COM-LOG list.

Cause: A certain problem occurred in networking.

Remedy: Check and take actions mentioned below.

- Check networking conditions and connections.
- Turn on the power supply of this machine and perform a communication test about 60 seconds later.

No.4

Symptom: "Unknown error" is displayed though a communication test has done successfully.

Cause: It could be a problem at the UGW side or the network load is temporarily faulty.

Remedy: Try again after a period of time. If the same error persists, check the UGW status with a network and UGW administrator.

No.5

Symptom: When a communication test (COM-TEST) is repeatedly executed, an error occurs.

Cause: During communication conducted after execution of a COM-TEST, another COM-TEST was executed again.

Remedy: When repeatedly executing COM-TEST, execute COM-TEST at intervals of 5 minutes or more.

Error code and strings

The following error information is output in the communication error log details display screen. (Here, "a server" means UGW.)

- The error information are displayed in the following form.
[*] [Error strings] [Method name] [Error details provided by UGW]

NOTE:

"**" is added to the top of the error text in the case of an error in communication test (method name: getConfiguration or communicationTest) only.

No.	Code	Error strings	Cause	Remedy
1	0000 0000	SUSPEND: mode changed.	Unmatched Operation Mode	Initialize the E-RDS setting (E-RDS > CLEAR).
2	0500 0003	SUSPEND: Communication test is not performed.	Rebooting the device while the communication test had not been performed although E-RDS is enabled.	Perform a communication test (COM-TEST).
3	0xxx 0003	Server schedule is not exist	Blank schedule data have been received from UGW.	Perform and complete a communication test (COM-TEST).
4	0xxx 0003	Communication test is not performed	Communication test has not completed.	Perform and complete a communication test (COM-TEST).
5	84xx 0003	E-RDS SWITCH is setted OFF	A communication test has been attempted with the E-RDS SWITCH being OFF.	Set E-RDS SWITCH (E-RDS) to ON, and then perform a communication test (COM-TEST).
6	8600 0002 8600 0003 8600 0101 8600 0201 8600 0305 8600 0306 8600 0401 8600 0403 8600 0414 8600 0415	Event Registration is Failed	Processing (event processing) within the device has failed.	Turn the device OFF/ ON. If the error persists, replace the device system software. (Upgrade)
7	8700 0306	SRAM version unmatch!	Improper value is written in at the head of the Main Controller PCB 2 SRAM domain of E-RDS.	Turn the device OFF/ ON.
8	8xxx 0004	Operation is not supported	Method which E-RDS is not supporting attempted.	Contact help desk

No.	Code	Error strings	Cause	Remedy
9	8xxx 0101	Server response error (NULL)	Communication with UGW has been successful, but an error of some sort has prevented UGW from responding. When (Null) is displayed at the end of the message, this indicates that there has been an error in the HTTPS communication method.	Perform and complete a communication test (COM-TEST).
10	8xxx 0201 8xxx 0202 8xxx 0203 8xxx 0204 8xxx 0206	Server schedule is invalid	During the communication test, there has been some kind of error in the schedule values passed from UGW.	When the error occurs, report the details to the support section. After the UGW side has responded, try the communication test again.
11	8xxx 0207 8xxx 0208	Internal Schedule is broken	The schedule data in the inside of E-RDS is not right.	Perform a communication test (COM-TEST).
12	8xxx 0221	Server specified list is too big	Alarm/Alert filtering error: The number of elements of the list specified by the server is over restriction value.	Alert filtering is not supported by UGW.
13	8xxx 0222	Server specified list is wrong	Alarm filtering error: Unjust value is included in the element of the list specified by the server.	Alert filtering is not supported by UGW.
14	8xxx 0304	Device is busy, try later	The semaphore consumption error at the time of a communication test.	Try again a communication test after a period of time.
15	8xxx 2000	Unknown error	Some other kind of communication error has occurred.	Perform and complete a communication test (COM-TEST).
16	8xxx 2001	URL Scheme error(not https)	The header of the URL of the registered UGW is not in https format.	Check that the value of URL of UGW (RGW-ADDRESS) is https://a01.ugwdevice.net/ugw/agentif010.
17	8xxx 2002	URL server specified is illegal	A URL different to that specified by the UGW has been set.	Check that the value of URL of UGW (RGW-ADDRESS) is https://a01.ugwdevice.net/ugw/agentif010.
18	8xxx 2003	Network is not ready, try later	Communication attempted without confirming network connection, just after booting up a device in which the network preparations are not ready.	Check the network connection, as per the initial procedures described in the troubleshooting. Perform a communication test (COM-TEST) about 60 seconds later, after turn on the device.

No.	Code	Error strings	Cause	Remedy
19	8xxx 2004	Server response error ([Hexadecimal]) [Error detailed in the UGW] ¹	Communication with UGW has been successful, but an error of some sort has prevented UGW from responding.	Try again after a period of time. Check detailed error code (Hexadecimal) and [Error details in UGW] from UGW displayed after the message.
20	8xxx 200A	Server connection error	<ul style="list-style-type: none"> TCP/IP communication fault The IP address of device is not set. 	<ul style="list-style-type: none"> Check the network connection, as per the initial procedures described in the troubleshooting. When proxy is used, make the settings for proxy, and check the status of the proxy server.
21	8xxx 200B	Server address resolution error	Server address name resolution has failed.	<ul style="list-style-type: none"> Check that the value of URL of UGW (RGW-ADDRESS) is https://a01.ugwdevice.net/ugw/agentif010. Check that Internet connection is available in the environment.
22	8xxx 2014	Proxy connection error	Could not connect to proxy server due to improper address.	Check proxy server address / port and re-enter as needed.
23	8xxx 2015	Proxy address resolution error	Could not connect to proxy server due to name resolution error of proxy address.	<ul style="list-style-type: none"> Check that the proxy server name is correct. If the proxy server name is correct, check the DNS connection, as per the initial procedures described in the troubleshooting. Specify the IP address as the proxy server name.
24	8xxx 201E	Proxy authentication error	Proxy authentication is failed.	Check the user name and password required in order to login to the proxy, and re-enter as needed.
25	8xxx 2028	Server certificate error	<ul style="list-style-type: none"> No route certificate installed in device. Certificate other than that initially registered in the user's operating environment is being used, but has not been registered with the device. The date and time of the device is not correct. 	<ul style="list-style-type: none"> Install the latest device system software. (Upgrade) Correctly set the date and time of the device. Execute CLEAR > CA-KEY, and turn OFF and then ON the device. (The CA certificate at the time of shipment is automatically installed.)

SSL

In this machine, there is not SSL which was made by default. It is necessary to make it from Remote UI when you use it.

Note:

SSL encrypted communication function

This is a function that enables exchange of encrypted data between this printer and a computer when performing IPP printing in which data is printed via a network or when using the Remote UI in which you manage the printer with the Web browser.

Using the SSL encrypted communication function achieves safer printing environments by preventing theft and falsification of data.

Caution:

When you are managing SSL, it disappears by board exchange. Therefore it is necessary to make it again.

A making procedure

There are two ways below.

Newly Creating a Key and Its Certificate

1. Start the Remote UI, and then log in as Administrator.

2. Select [Settings/Registration] > [Management Settings] > [Security] > [Key and Certificate Settings].

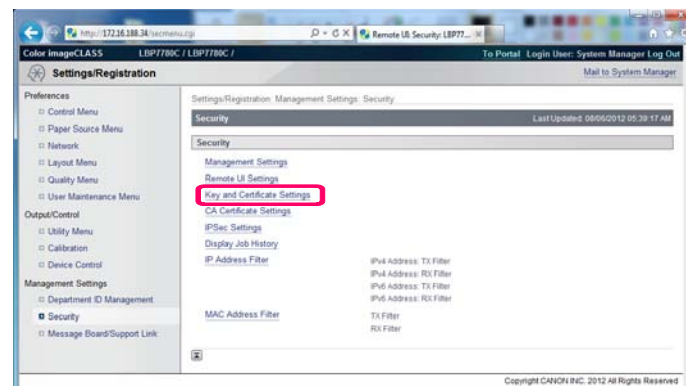

F-2-167

3. Click [Generate Key].

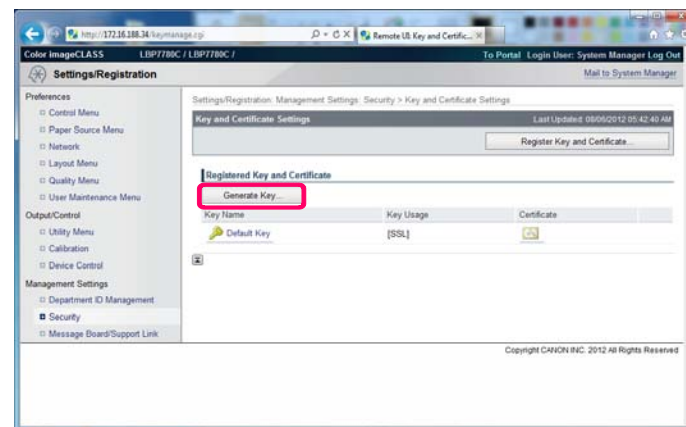

F-2-168

4. Enter the name of the key to be newly created. Up to 24 alphanumeric characters can be entered.

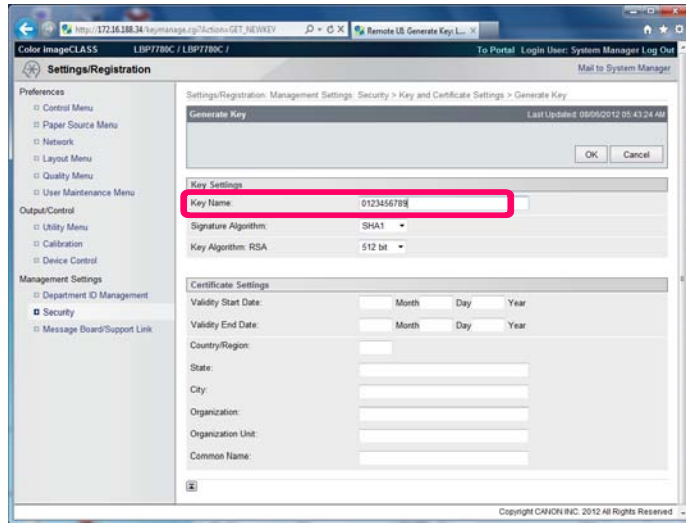

F-2-169

5. Select [Signature Algorithm]. Select from [512 bit], [1024 bit], [2048 bit], or [4096 bit].

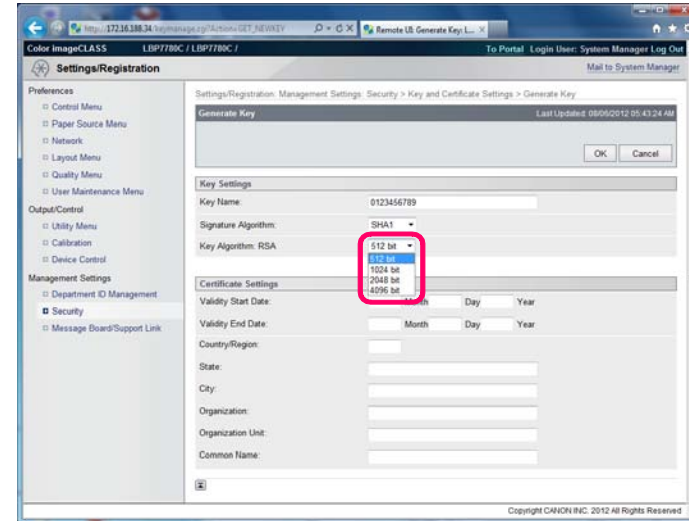

F-2-171

Note:

- Key Generation Algorithm
The generation algorithm when the printer generates a key is RSA.
- About the key length
Although using the longer key makes it more difficult to decode data, the processing speed on encryption and decryption is slower.

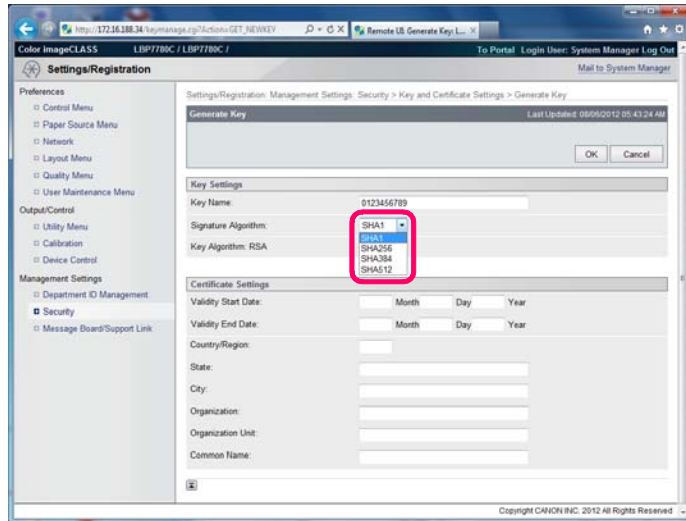

F-2-173

6. Select [Key Algorithm]. Select from [SHA1], [SHA256], [SHA384], or [SHA512]. For [SHA384] and [SHA512], you can create a key only when other than [512 bit] is selected for [RSA].

7. Specify the effective date and expiration date and the country/region name for the self-sign server certificate. Then click [OK]. → The key and certificate creation starts.

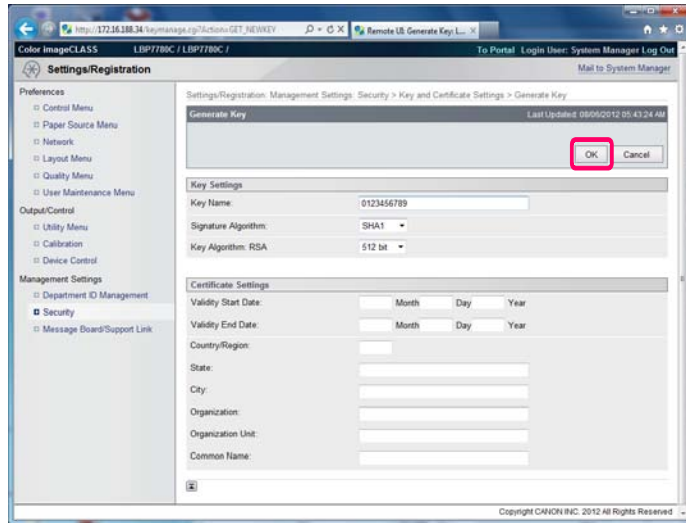

F-2-172

● Installing a Key/Certificate File on the Printer

If there are an extra Key and Certificate file, you can also install/register it from a PC.

1. Click [Register Key and Certificate].

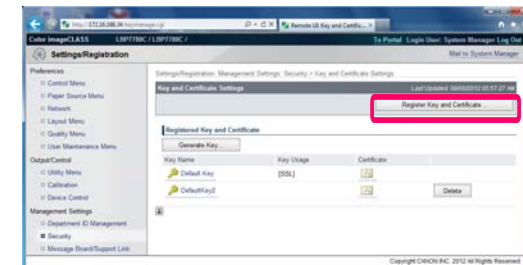

F-2-173

2. Click [Install].

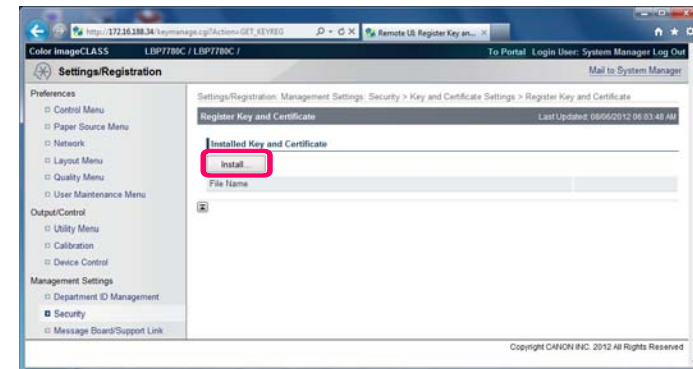

F-2-174

3. Specify the directory of a key/certificate file.

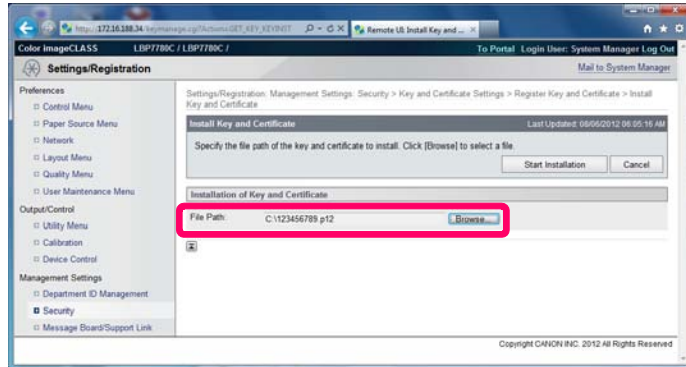

F-2-175

4. Click [Start installation].→ The installation of the key/certificate file starts

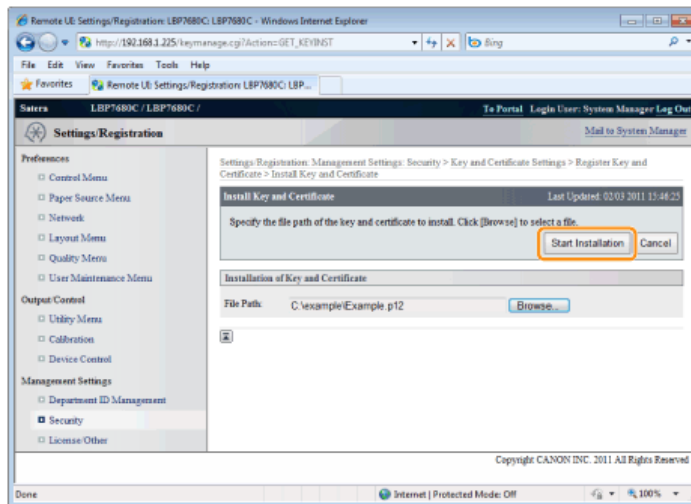

F-2-176

5. Click [Register Key and Certificate].

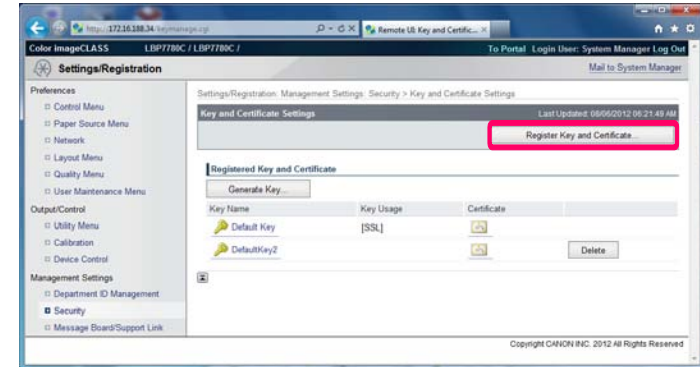

F-2-177

6. Click [Register].

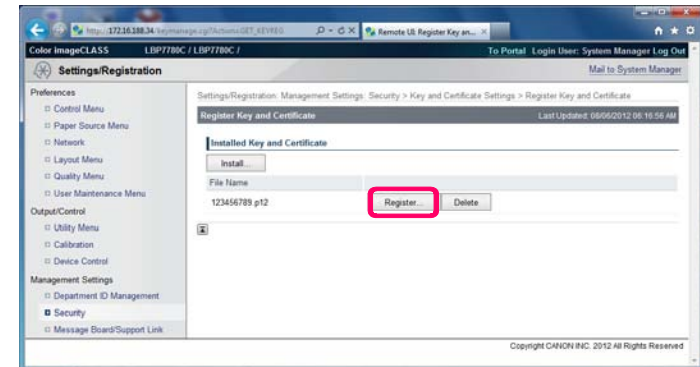

F-2-178

7. Enter the name of the key to be registered.

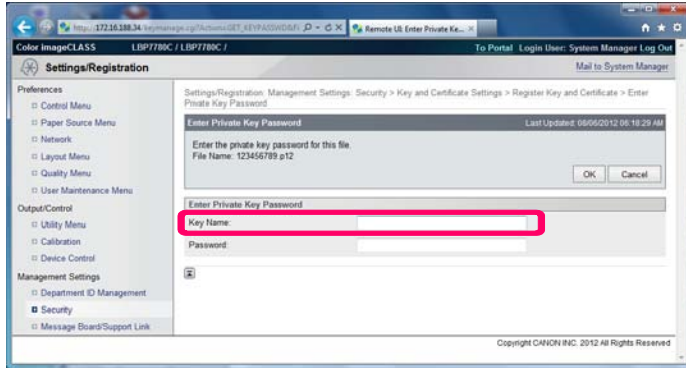

F-2-179

9. Click [OK]. → The key and certificate registration starts.

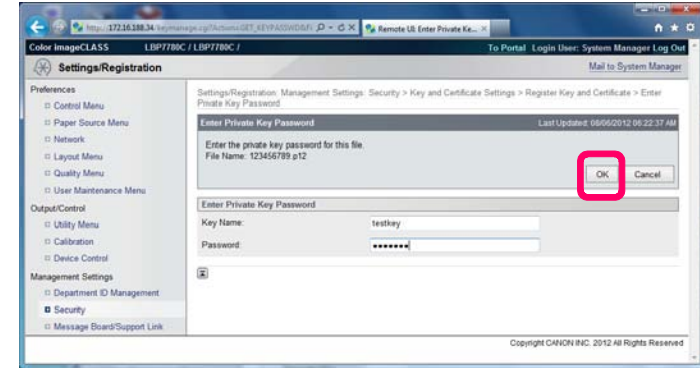

F-2-181

8. Enter the password specified for the private key.

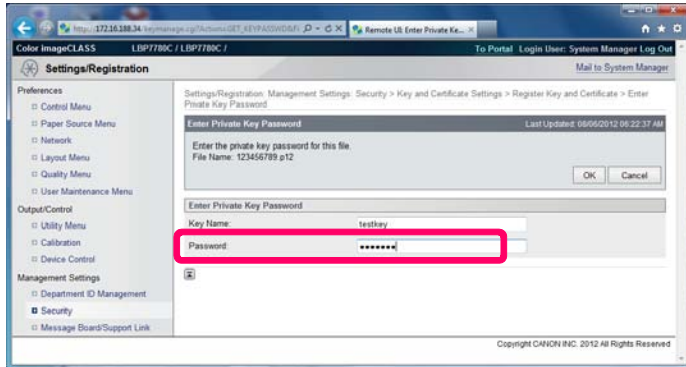

F-2-180

■ Setting the SSL Encryption Communication Function

Select the Key and Certificate which was made or registered by the method mentioned.

● Selecting Keys and Certificates

1. Start the Remote UI, and then log in as Administrator.
2. Click [Settings/Registration].

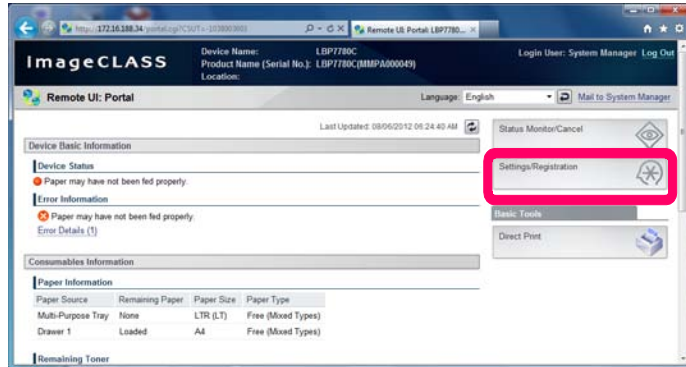

F-2-182

3. Select [Network] from the [Preferences] menu.

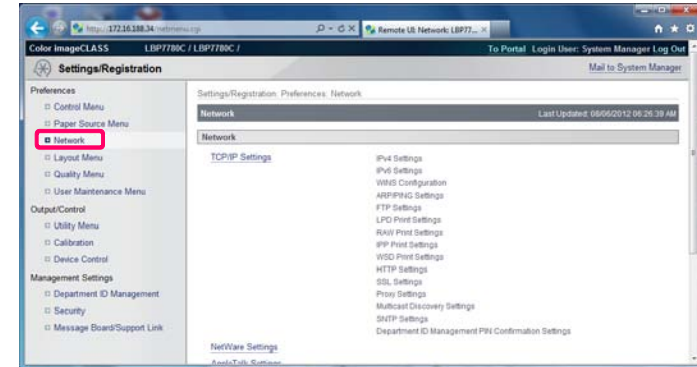

F-2-183

4. Click [TCP/IP Settings].

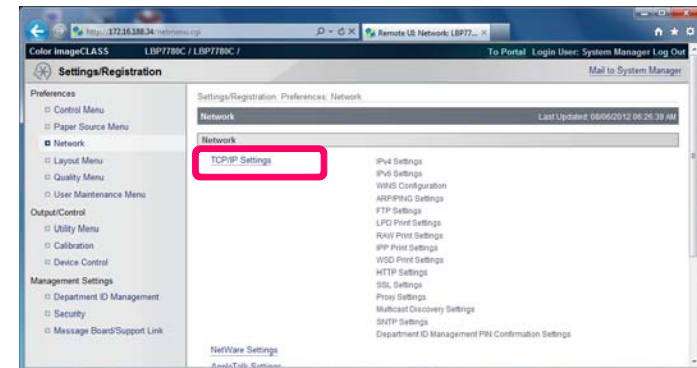

F-2-184

5. Click [Key and Certificate] under [SSL Settings].

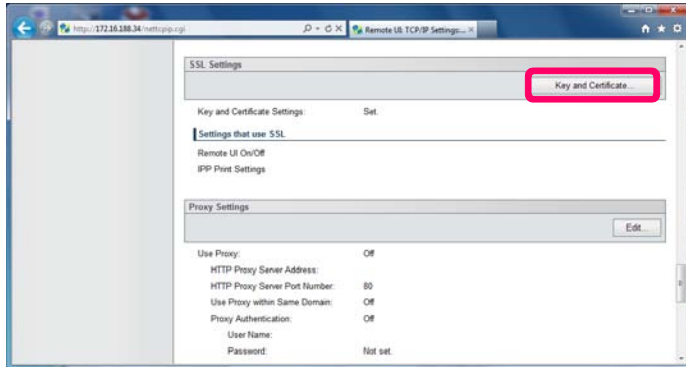

F-2-185

6. Select the key to use, and then click [Default Key Settings].

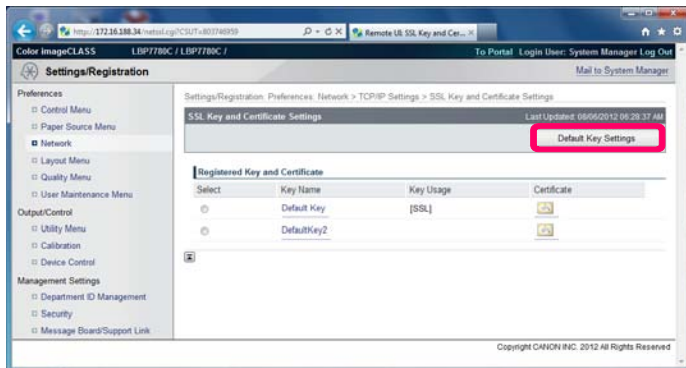

F-2-186

7. Click [OK].

● Changing the Remote UI Settings

Specify whether the SSL encrypted communication function should be used for the Remote UI.

1. Start the Remote UI, and then log in as Administrator.
2. Click [Settings/Registration].

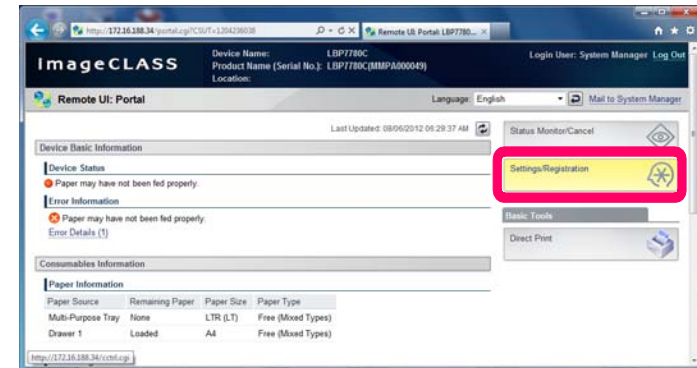

F-2-187

3. Select [Security] from the [Management Settings] menu.

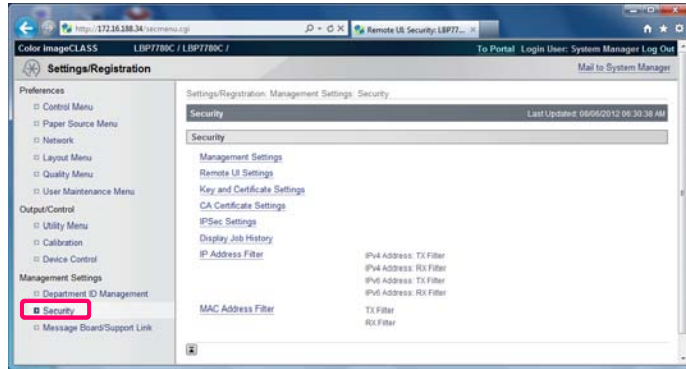

F-2-188

4. Click [Remote UI Settings].

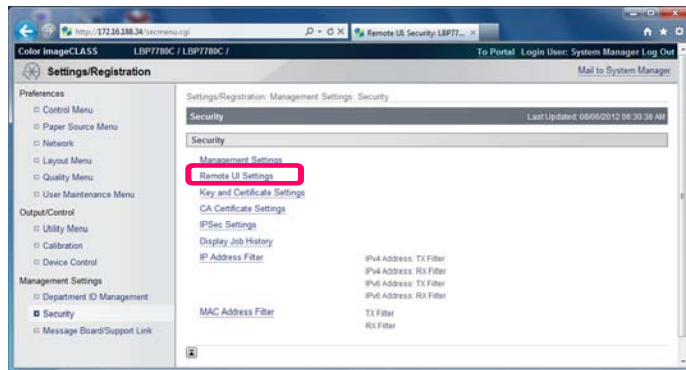

F-2-189

5. Click [Edit].

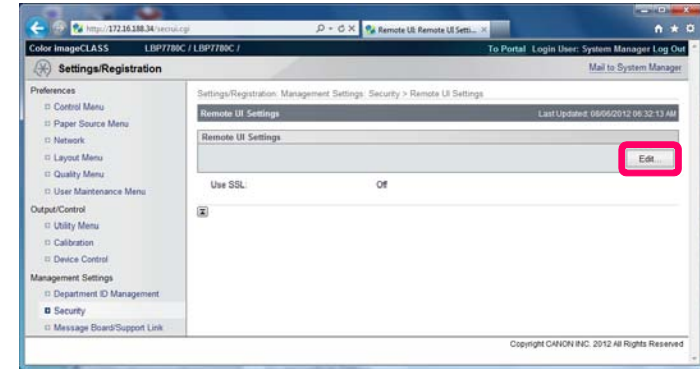

F-2-190

6. Change the Remote UI settings.

(1) Select the [Use SSL] check box.

If you clear the check box, the remote UI cannot use SSL encrypted communication.

(2) Click [OK].

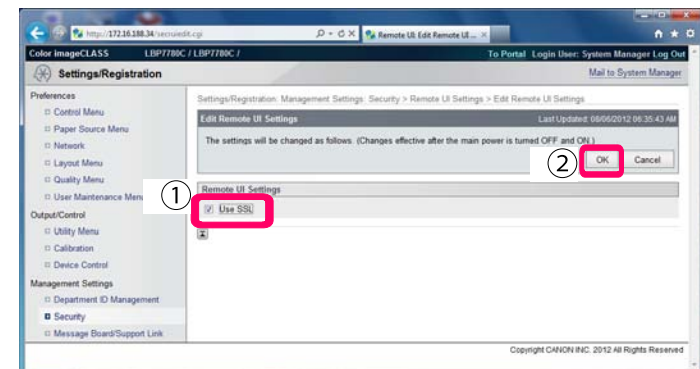

F-2-191

Caution:

You cannot select the [Use SSL] check box if a key and certificate are not created and registered in advance and a key used by SSL is not selected.

7. Perform a hard reset or restart the printer.→ After performing a hard reset or restarting the printer, the settings are effective.

Note:

You can perform a hard reset using the following procedure.

1. Click [Settings/Registration].
2. Select [Device Control] from the [Output/Control] menu.
3. Select [Hard Reset], then click [Execute].

3

Disassembly and Assembly

- Introduction
- External-related Issues
- Main Units
- Main Parts
- PCB-related Issues

Introduction

Points to Note During Disassembly and Assembly

Be sure to pay attention to the below points in performing disassembly and assembly.

1. In performing disassembly and assembly, for safety precaution be sure to disconnect the power plug.
2. If there is no special instruction, perform the assembling work in the reverse way of disassembling procedure.
3. In the places where screws, etc. are used, be sure not to install them wrongly (length/diameter).
4. To ensure electric conduction, binding screw with washer is used for the mounting screws, e.g. for earth wire or varistor, etc. Be sure to use this screw in performing assembling-installing.
5. It is a basic rule that machine is not to be operated when the parts is in the removed condition.
6. In disassembling, do not remove the paint-locked screw.

Lay Out Drawing

External-related Issues

LBP7750C/LBP5460

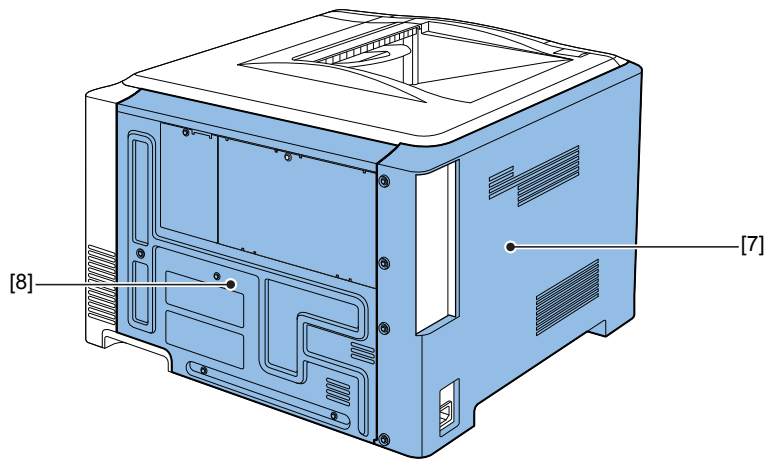
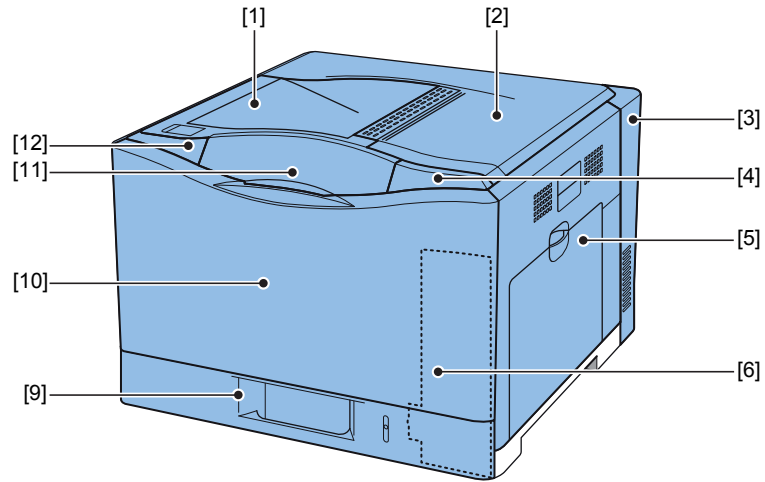

F-3-1

LBP7780C/LBP5480

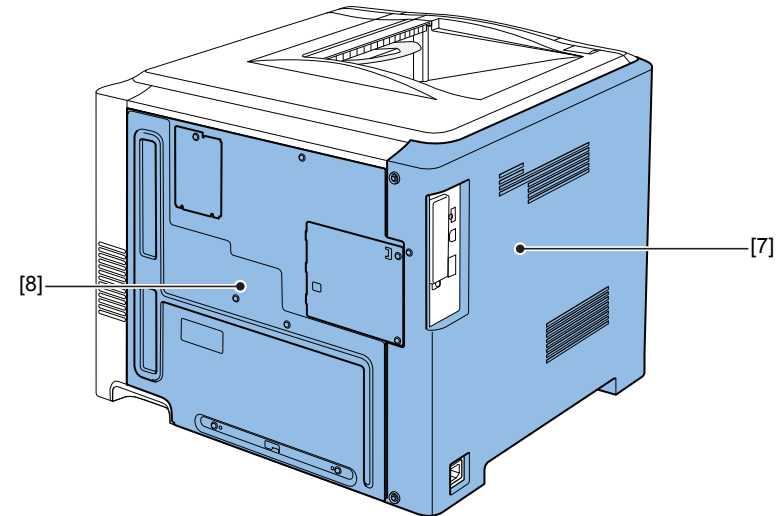
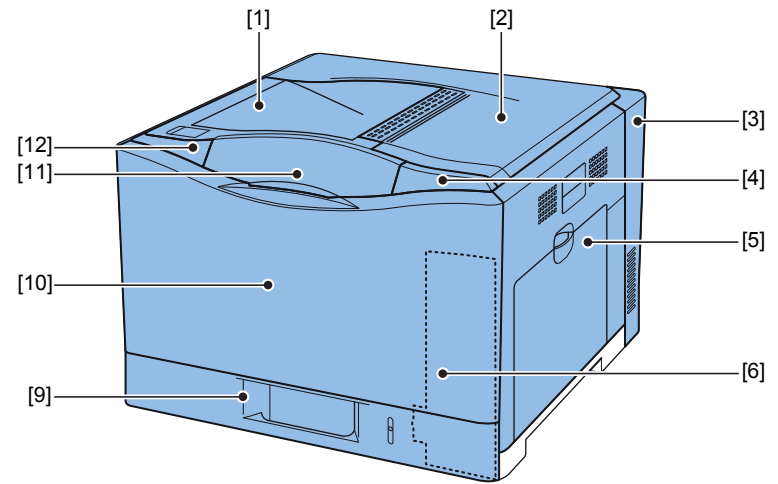

F-3-2

Number	Name	Reference (LBP7750C/5460)	Reference (LBP7780C/5480)
[1]	Upper front cover unit	(Refer to page 3-16)	(Refer to page 3-16)
[2]	Upper rear cover	(Refer to page 3-21)	(Refer to page 3-21)
[3]	Right rear cover	(Refer to page 3-13)	(Refer to page 3-13)
[4]	Control panel unit right cover	(Refer to page 3-14)	(Refer to page 3-14)
[5]	Right cover unit	(Refer to page 3-25)	(Refer to page 3-25)
[6]	Front right cover	(Refer to page 3-23)	(Refer to page 3-24)
[7]	Left cover	(Refer to page 3-11)	(Refer to page 3-11)
[8]	Rear cover	(Refer to page 3-12)	(Refer to page 3-12)
[9]	Cassette	-	-
[10]	Front cover unit	(Refer to page 3-22)	(Refer to page 3-22)
[11]	Control panel unit	(Refer to page 3-17)	(Refer to page 3-20)
[12]	Control panel unit left cover	(Refer to page 3-15)	(Refer to page 3-15)

T-3-1

■ Main Units

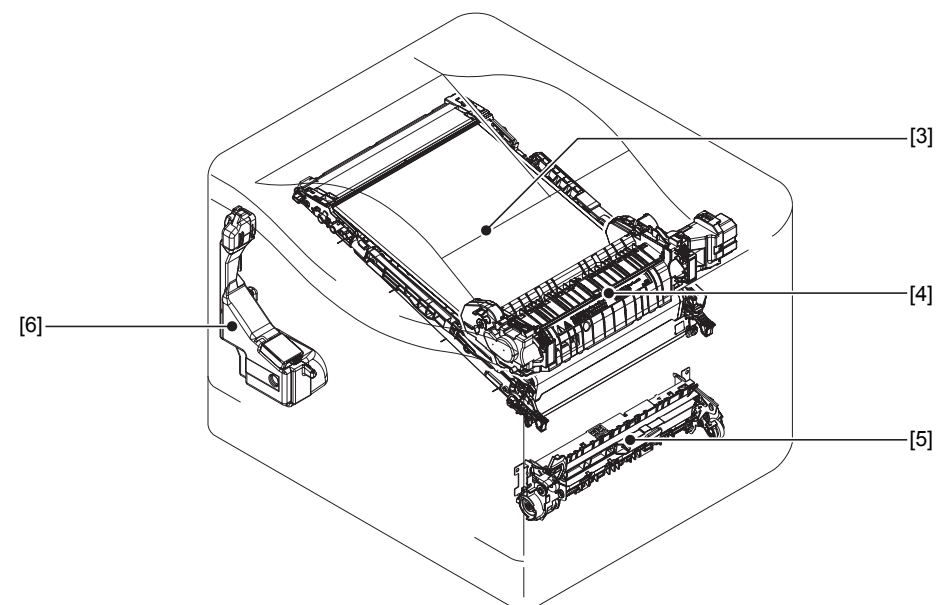
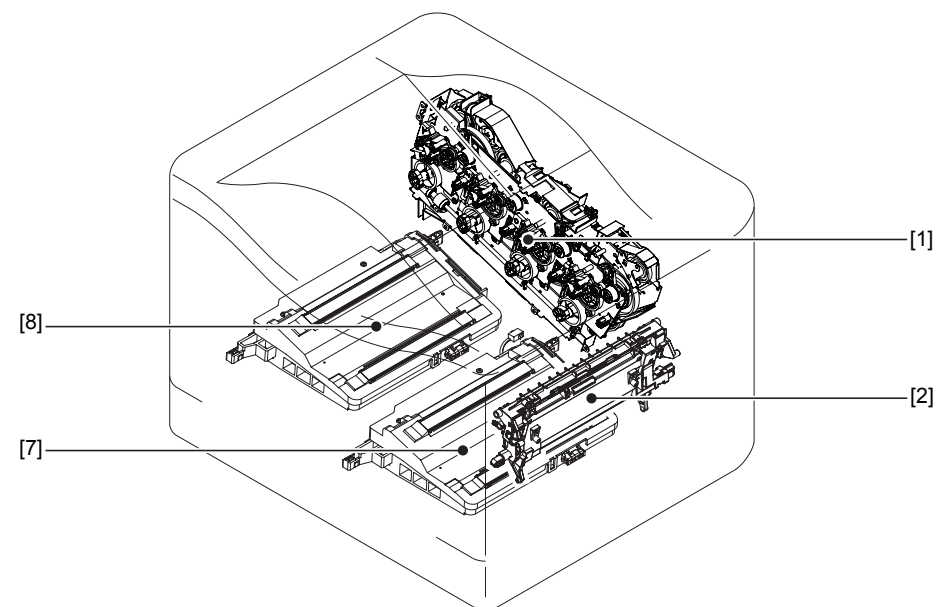

F-3-3

Number	Name	Reference (LBP7750C/5460)	Reference (LBP7780C/5480)
[1]	Main drive unit	(Refer to page 3-55)	(Refer to page 3-58)
[2]	Secondary transfer unit	(Refer to page 3-27)	(Refer to page 3-27)
[3]	ITB unit	(Refer to page 3-27)	(Refer to page 3-27)
[4]	Fixing assembly	(Refer to page 3-28)	(Refer to page 3-28)
[5]	Registration unit	(Refer to page 3-34)	(Refer to page 3-35)
[6]	Waste toner container	(Refer to page 3-29)	(Refer to page 3-29)
[7]	C/Bk laser scanner unit	(Refer to page 3-41)	(Refer to page 3-45)
[8]	Y/M laser scanner unit	(Refer to page 3-41)	(Refer to page 3-45)

T-3-2

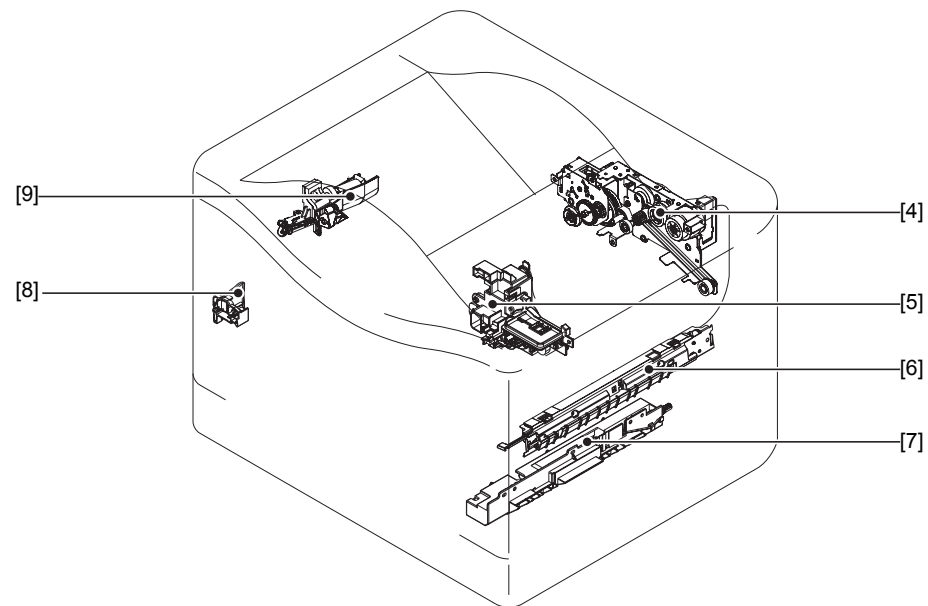
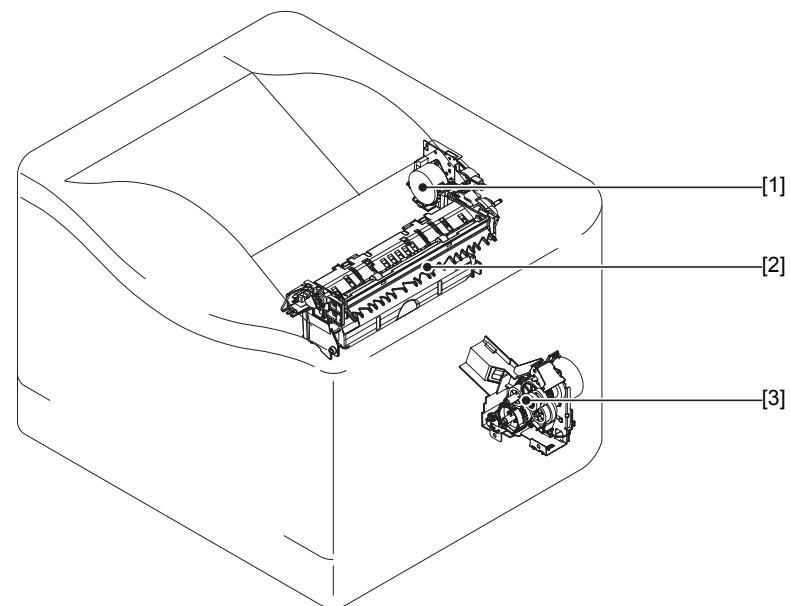

F-3-4

Number	Name	Reference (LBP7750C/5460)	Reference (LBP7780C/5480)
[1]	Duplex drive unit	(Refer to page 3-68)	(Refer to page 3-69)
[2]	Delivery unit	(Refer to page 3-64)	(Refer to page 3-66)
[3]	Cassette pickup drive unit	(Refer to page 3-50)	(Refer to page 3-50)
[4]	Fixing drive unit	(Refer to page 3-61)	(Refer to page 3-63)
[5]	Lifter drive unit	(Refer to page 3-39)	(Refer to page 3-40)
[6]	Color displacement/density sensor unit	(Refer to page 3-37)	(Refer to page 3-38)
[7]	Cassette pickup unit	(Refer to page 3-52)	(Refer to page 3-53)
[8]	Waste toner full sensor unit	(Refer to page 3-30)	(Refer to page 3-31)
[9]	Waste toner feed motor unit	(Refer to page 3-32)	(Refer to page 3-33)

T-3-3

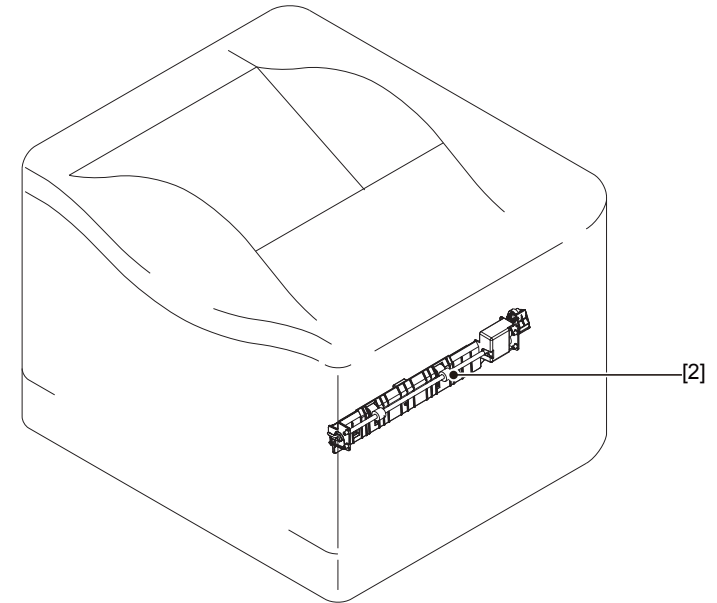
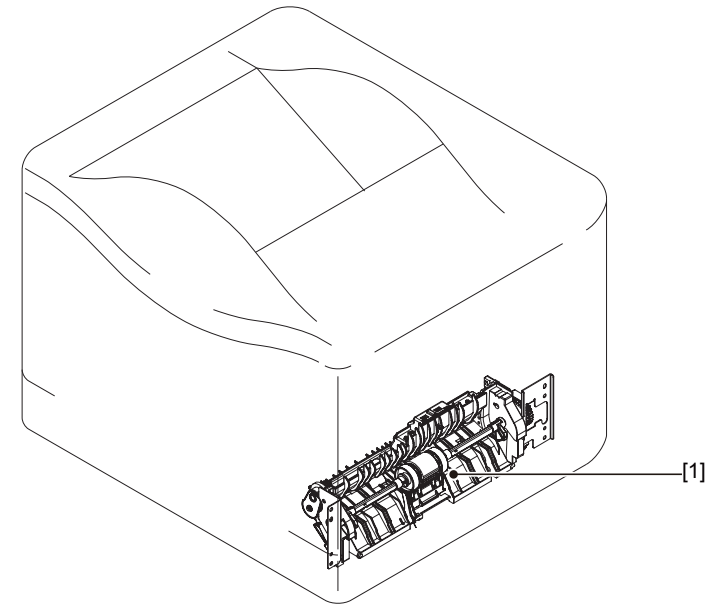

F-3-5

Number	Name	Reference (LBP7750C/5460)	Reference (LBP7780C/5480)
[1]	Multi-purpose tray pickup unit	(Refer to page 3-71)	(Refer to page 3-74)
[2]	Duplex feed roller unit	(Refer to page 3-70)	(Refer to page 3-71)

T-3-4

■ Main Parts

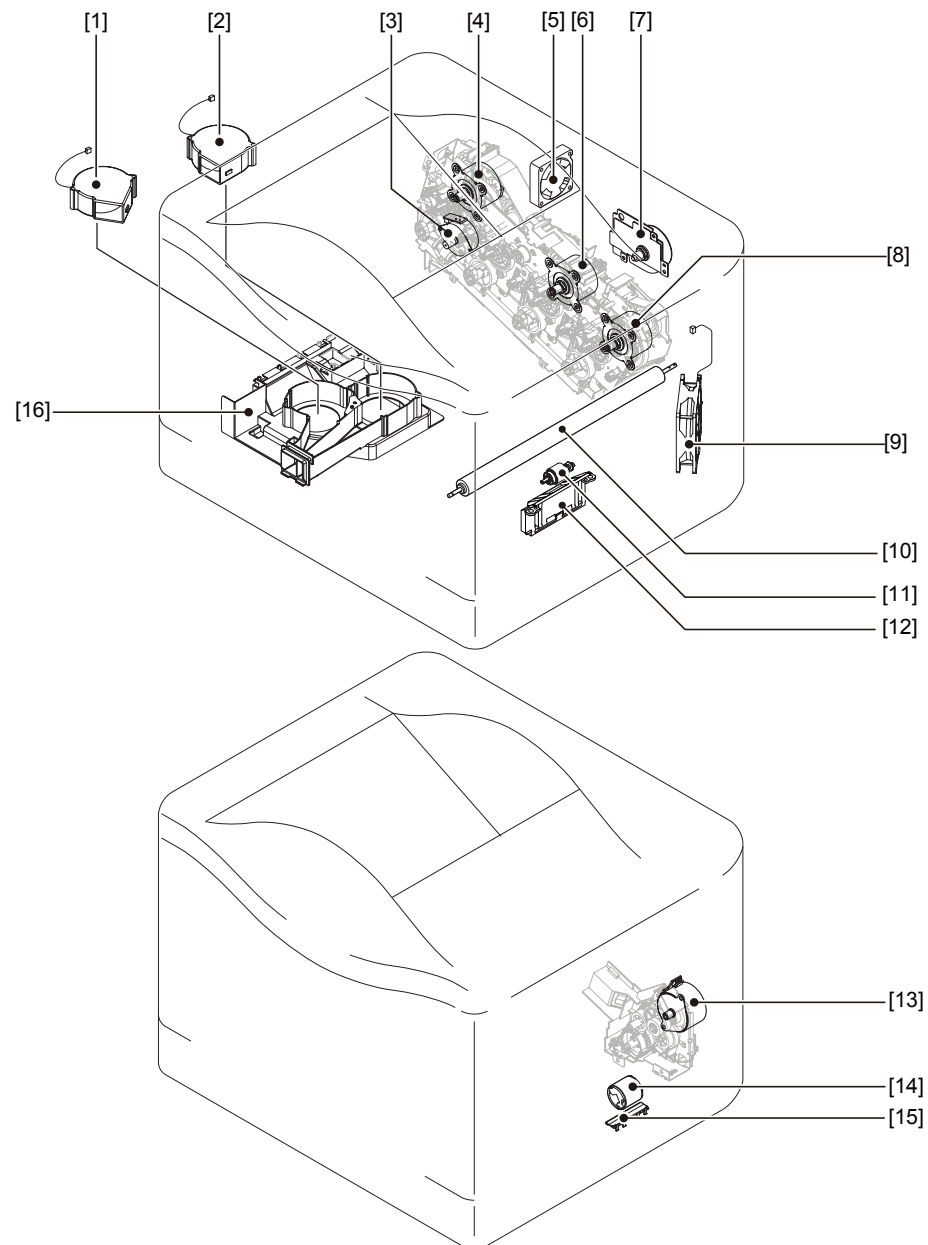

F-3-6

Number	Name	Reference (LBP7750C/5460)	Reference (LBP7780C/5480)
[1]	Delivery fan	(Refer to page 3-93)	(Refer to page 3-94)
[2]	Cartridge fan	(Refer to page 3-95)	(Refer to page 3-96)
[3]	Developing disengagement motor	(Refer to page 3-86)	(Refer to page 3-86)
[4]	Drum motor 1	(Refer to page 3-89)	(Refer to page 3-89)
[5]	Controller fan	(Refer to page 3-99)	(Refer to page 3-99)
[6]	Drum motor 2	(Refer to page 3-90)	(Refer to page 3-90)
[7]	Fixing motor	(Refer to page 3-92)	(Refer to page 3-92)
[8]	Drum motor 3	(Refer to page 3-91)	(Refer to page 3-91)
[9]	Power fan	(Refer to page 3-79)	(Refer to page 3-81)
[10]	Secondary transfer outer roller unit	(Refer to page 3-86)	(Refer to page 3-86)
[11]	Cassette pickup roller	(Refer to page 3-77)	(Refer to page 3-78)
[12]	Cassette separation roller assembly	(Refer to page 3-79)	(Refer to page 3-79)
[13]	Pickup motor	(Refer to page 3-87)	(Refer to page 3-88)
[14]	Multi-purpose tray pickup roller	-	-
[15]	Multi-purpose tray separation pad	-	-
[16]	Fan unit	(Refer to page 3-82)	(Refer to page 3-84)

T-3-5

■ PCB-related Issues

● LBP7750C/LBP5460

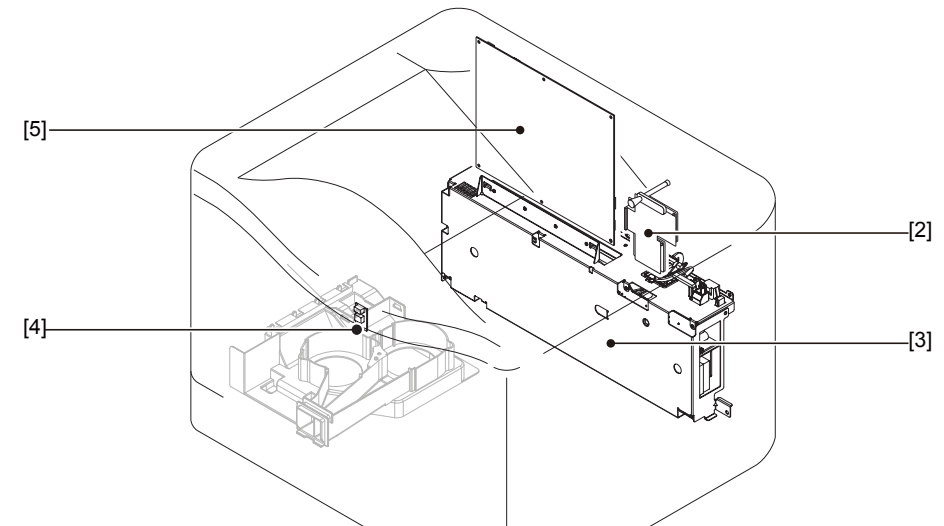
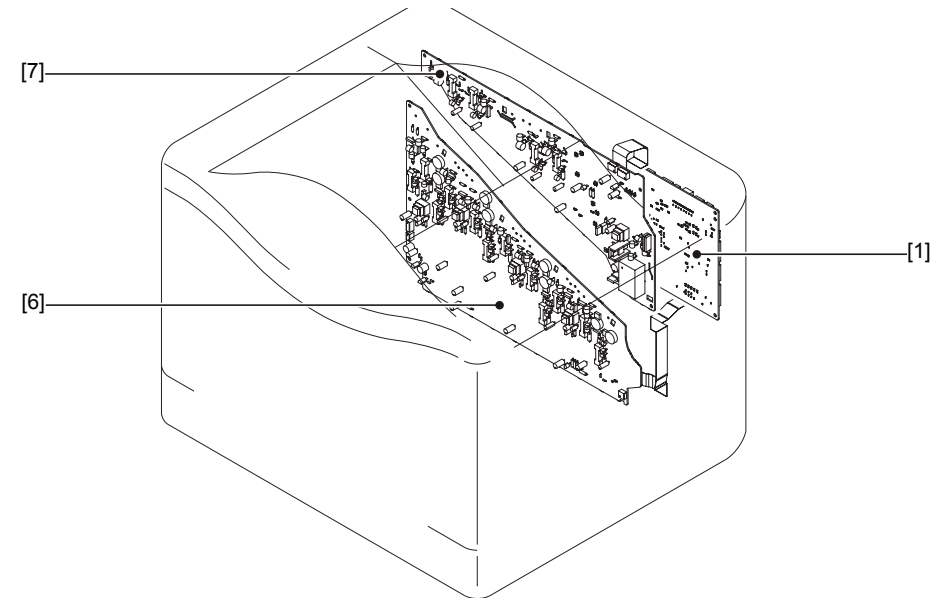

F-3-7

Number	Name	Reference
[1]	DC controller PCB	(Refer to page 3-113)
[2]	ICB PCB	(Refer to page 3-101)
[3]	Low-voltage power unit	(Refer to page 3-109)
[4]	Environment sensor	(Refer to page 3-122)
[5]	Main controller PCB	(Refer to page 3-101)
[6]	Lower high voltage power supply PCB	(Refer to page 3-115)
[7]	Upper high voltage power supply PCB	(Refer to page 3-119)

T-3-6

● LBP7780C/LBP5480

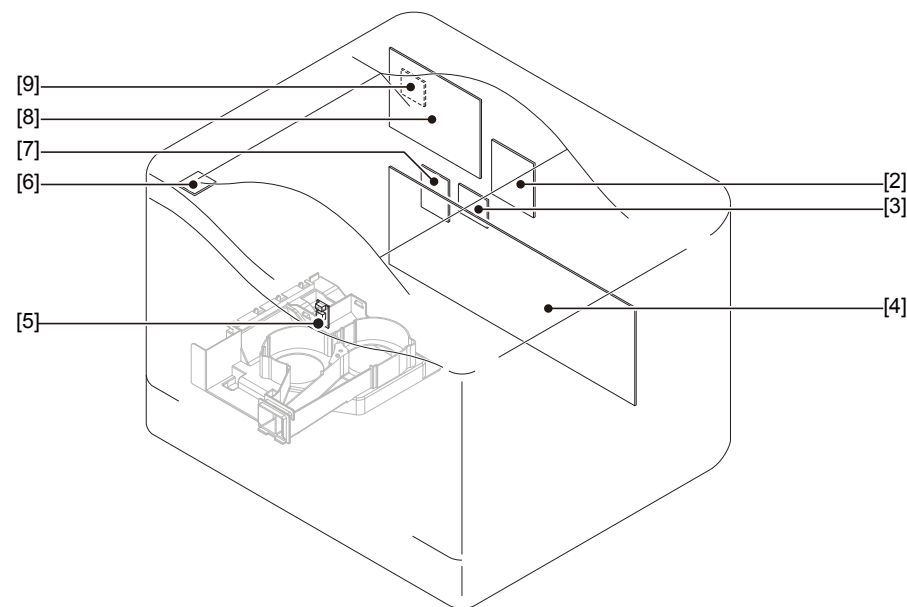
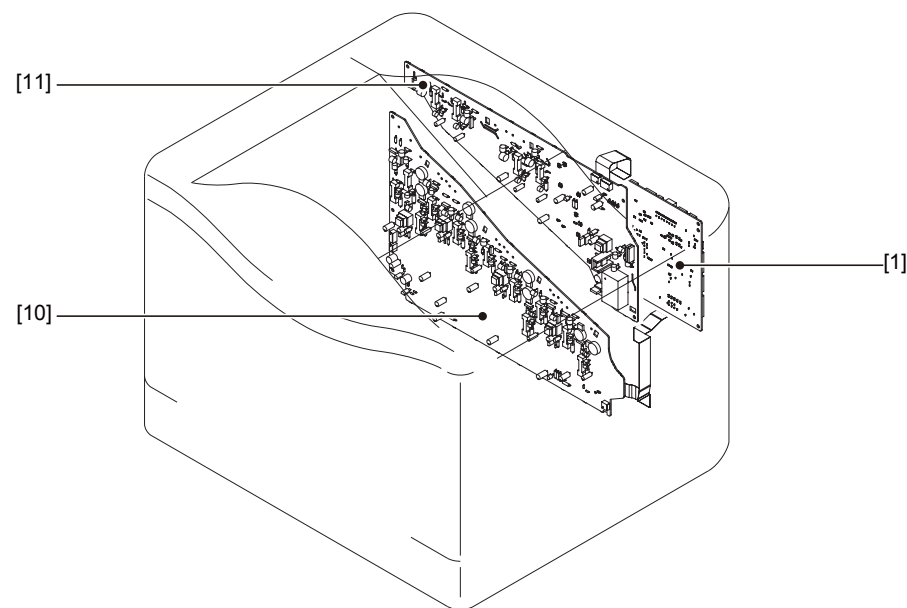

F-3-8

Number	Name	Reference
[1]	DC controller PCB	(Refer to page 3-114)
[2]	Sleep IF PCB	(Refer to page 3-108)
[3]	All night PCB	(Refer to page 3-107)
[4]	Low voltage power unit	(Refer to page 3-111)
[5]	Environment sensor	(Refer to page 3-122)
[6]	Power switch PCB	-
[7]	Relay PCB	(Refer to page 3-107)
[8]	Main controller PCB	(Refer to page 3-106)
[9]	SD card PCB	(Refer to page 3-108)
[10]	Lower high voltage power supply PCB	(Refer to page 3-117)
[11]	Upper high voltage power supply PCB	(Refer to page 3-121)

T-3-7

External-related Issues

Removing Left Cover

- 1) Remove the cassette.
- 2) Open the front cover unit.
- 3) Remove the 3 screws [1].

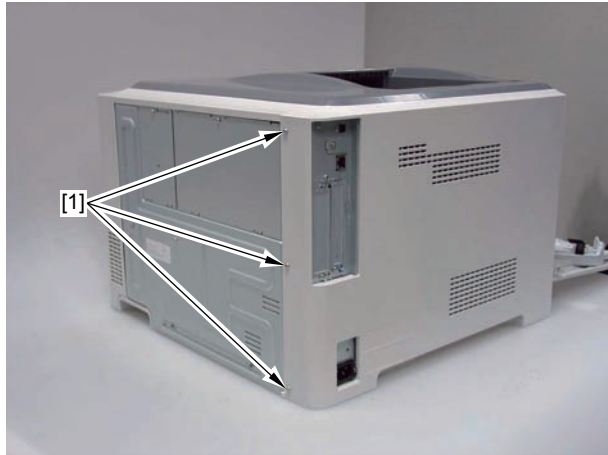

F-3-9

- 4) Remove the claw [1] in 1 place.
- 5) While pushing the lower right part [2] of Left Cover, slide it in the direction of the arrow and remove the Left Cover [3].

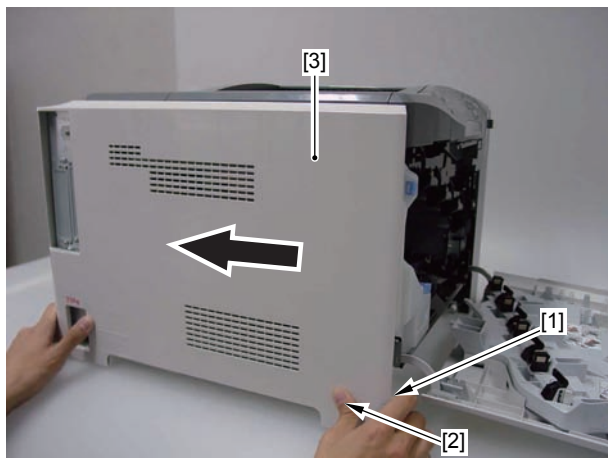

F-3-10

Removing Left Cover(LBP7780C/LBP5480)

- 1) Open the front cover unit.
- 2) Remove the 4 screws [1].

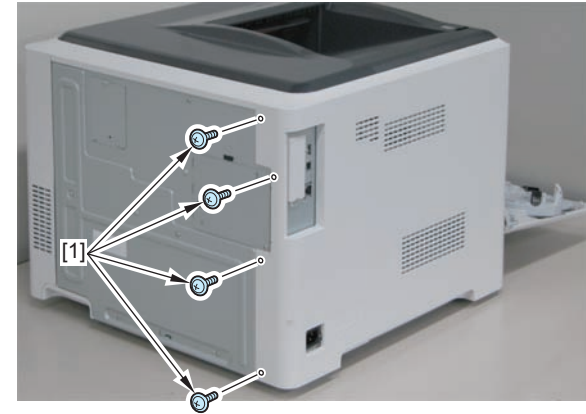

- 3) Slide the left cover[1] in the direction of the arrow and remove it.
 - 13 hooks[2]

F-3-11

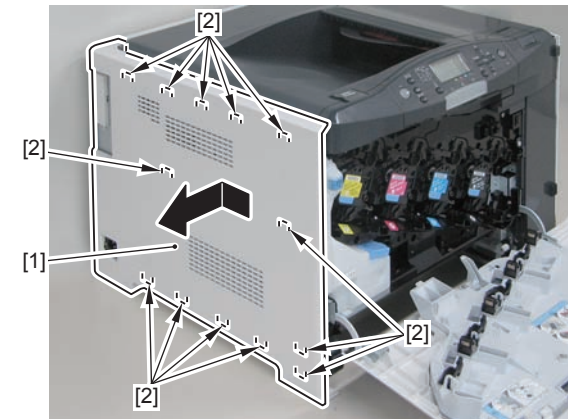

F-3-12

Removing Rear Cover

Before Removing Rear Cover

1) Remove the left cover. (Refer to page 3-11)

Removing the Rear Cover

1) Remove the Shield plate [1].

- 1 screw [2]

2) Remove the Rear Cover [3] in the direction of the allow.

- 5 screws [4]

- 1 hook [5]

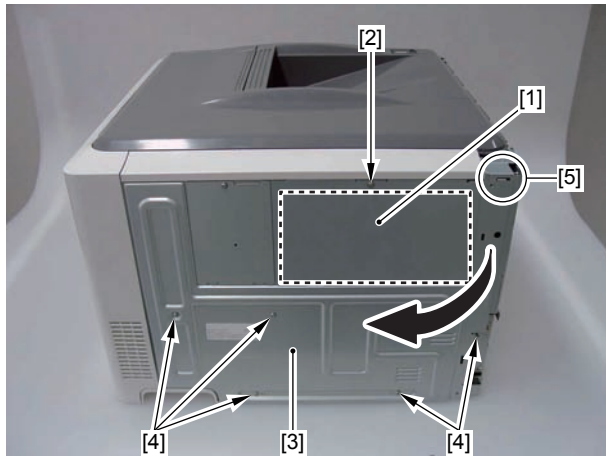

F-3-13

Removing Rear Cover(LBP7780C/LBP5480)

Before Removing Rear Cover

1) Remove the left cover. (Refer to page 3-11)

2) Remove the right rear cover. (Refer to page 3-13)

Removing the Rear Cover

1) Remove the Rear Cover [1] in the direction of the allow.

- 6 screws [2]

- 2 hooks [3]

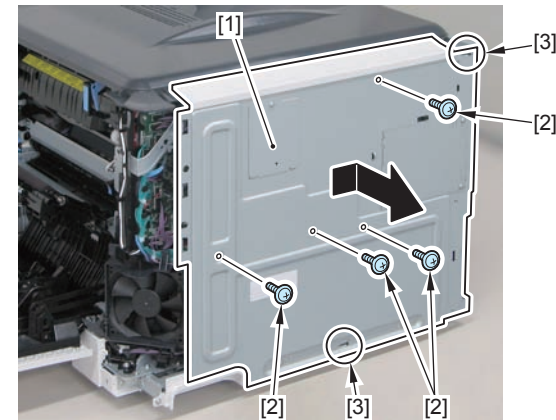

F-3-14

Removing Right Rear Cover

Before Removing Right Rear Cover

- 1) Remove the left cover.(Refer to page 3-11)
- 2) Remove the rear cover.(Refer to page 3-12)

Removing the Right Rear Cover

- 1) Open the right cover unit.
- 2) Remove the right rear cover [1].
 - 2 screws [2]
 - 1 hook [3]

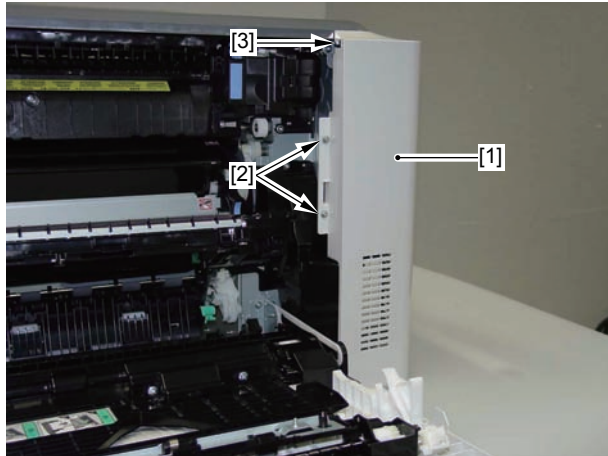

F-3-15

Removing Right Rear Cover(LBP7780C/LBP5480)

Removing the Right Rear Cover

- 1) Open the right cover unit.
- 2) Remove the right rear cover [1].
 - 2 screws [2]
 - 6 hooks [3]

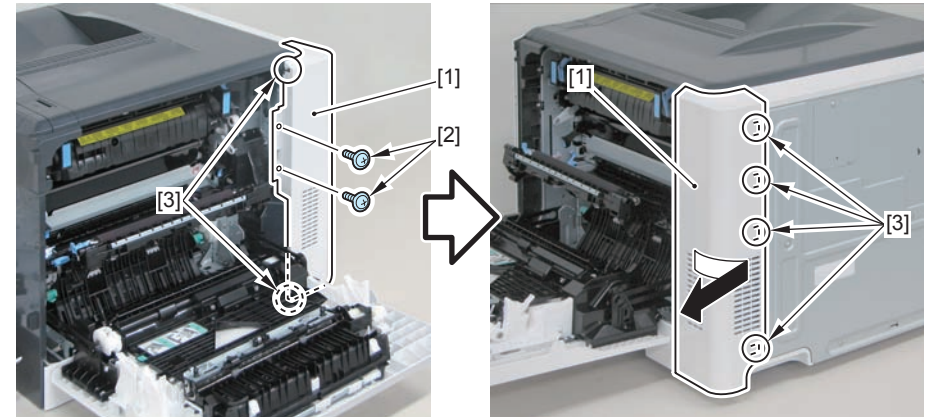

F-3-16

Removing the Control Panel Unit Right Cover

- 1) Open the front cover unit.
- 2) Open the right cover unit.
- 3) Remove the control panel unit right cover [1].
 - 2 screws [2]



F-3-17



F-3-18

Remove the Control Panel Unit Right Cover(LBP7780C/LBP5480)

- 1) Open the front cover unit.
- 2) Open the right cover unit.
- 3) Remove the control panel unit right cover [1].
 - 2 screws [2]

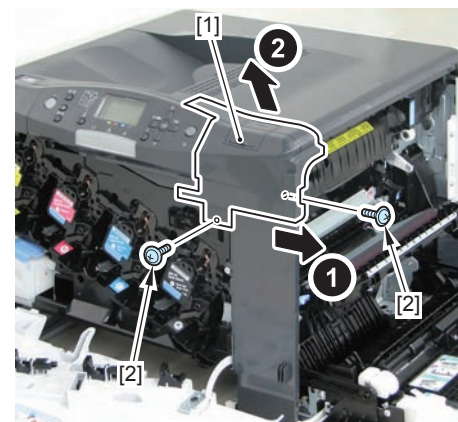

F-3-19

Removing the Control Panel Unit Left Cover

Before Removing Control Panel Unit Left Cover

1) Remove the left cover. (Refer to page 3-11)

Removing the Control Panel Unit Left Cover

1) Remove the control panel unit left cover [1].

- 1 screw [2]

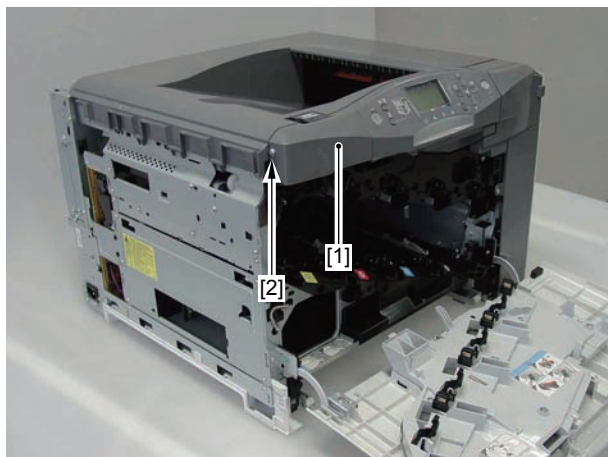

F-3-20

Removing the Control Panel Unit Left Cover(LBP7780C/LBP5480)

Before Removing Control Panel Unit Left Cover

1) Remove the left cover. (Refer to page 3-11)

Removing the Control Panel Unit Left Cover

1) Remove the control panel unit left cover [1].

- 1 screw [2]

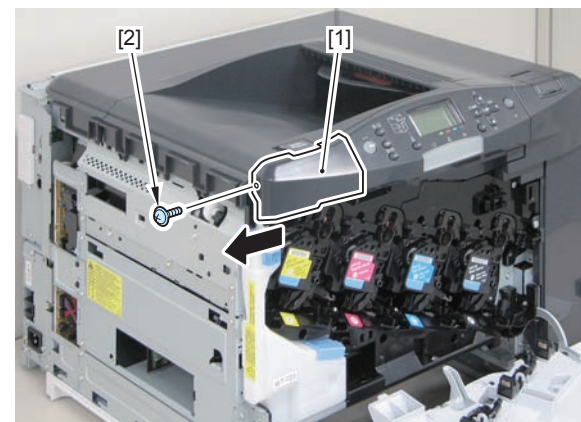

F-3-21

Removing Upper Front Cover Unit

Before removing upper front cover unit

- 1) Remove the control panel unit right cover. (Refer to page 3-14)
- 2) Remove the left cover. (Refer to page 3-11)
- 3) Remove the control panel unit left cover. (Refer to page 3-15)

Removing the Upper Front Cover Unit

- 1) Remove the connector [1] in 2 places.

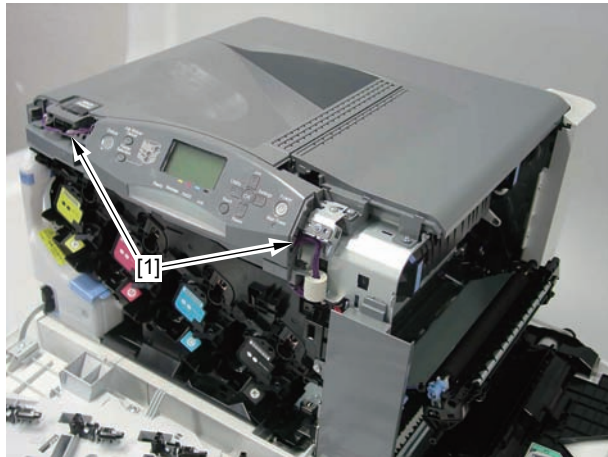

F-3-22

- 2) Slide the Upper Front Cover Unit [1] to the left and remove it.

- 2 screws [2] (1 in left side, 1 in front side)
- 1 boss [3]

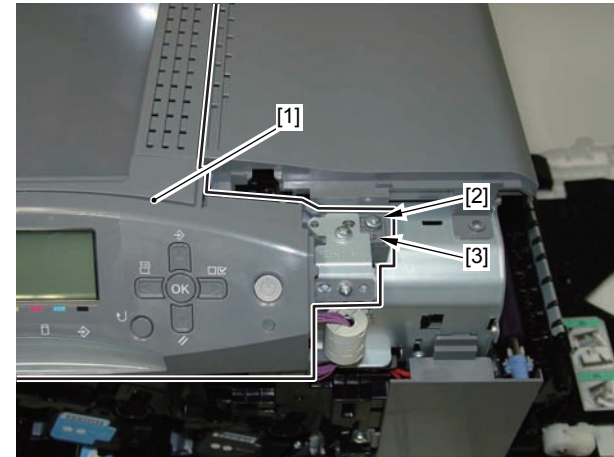

F-3-23

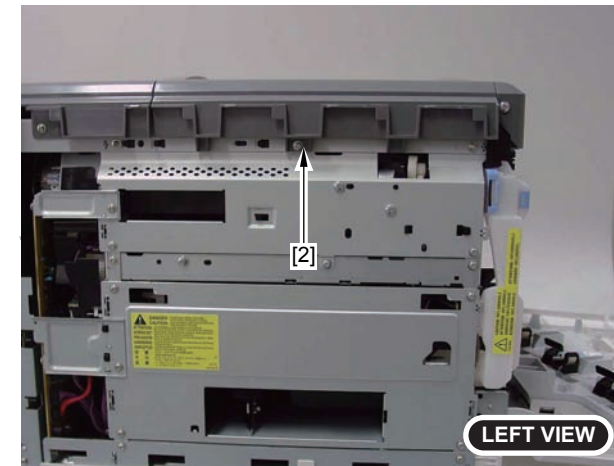

F-3-24

MEMO :

When installing upper front cover unit, be sure to install it to the host machine by passing the cable [1] to the hole [2] of the upper front cover unit.

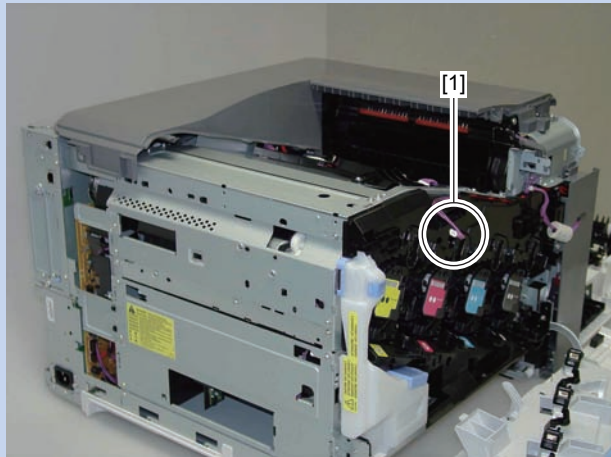

F-3-25

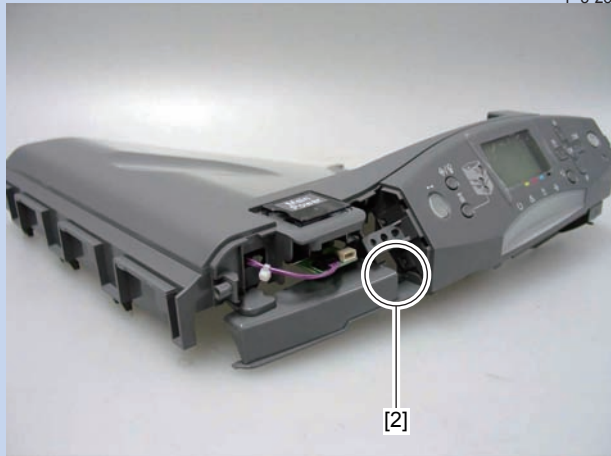

F-3-26

Removing Upper Front Cover Unit(LBP7780C/LBP5480)

Before removing upper front cover unit

- 1) Remove the control panel unit right cover.(Refer to page 3-14)
- 2) Remove the left cover.(Refer to page 3-11)
- 3) Remove the control panel unit left cover.(Refer to page 3-15)

Removing the Upper Front Cover Unit

- 1) Remove the connector [1] in 2 places.

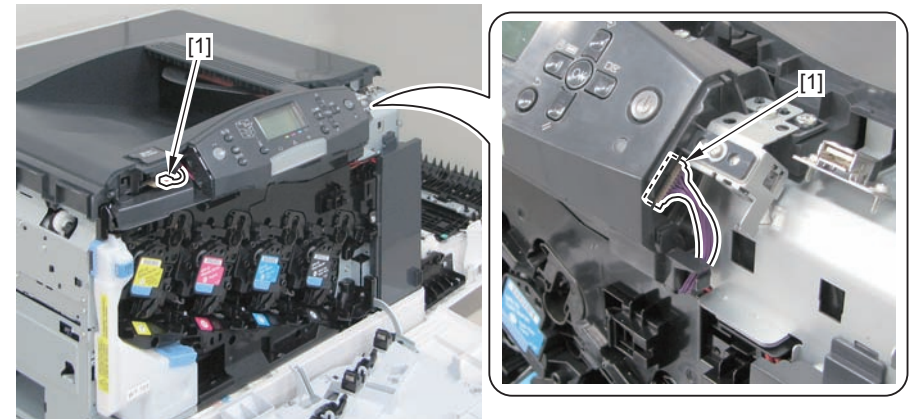

F-3-27

2) Slide the Upper Front Cover Unit [1] to the left and remove it.

- 2 screws [2] (1 in left side, 1 in front side)
- 1 boss [3]
- 2 hooks [4]

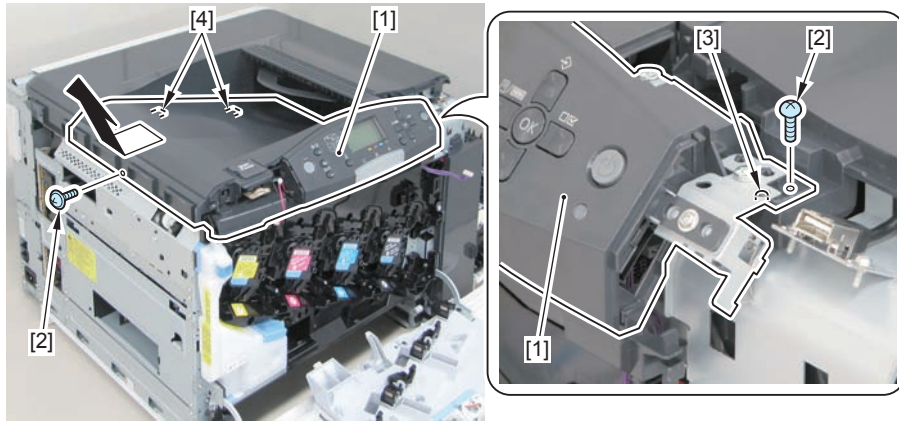

F-3-28

MEMO :

When installing upper front cover unit, be sure to install it to the host machine by passing the cable [1] to the hole [2] of the upper front cover unit.

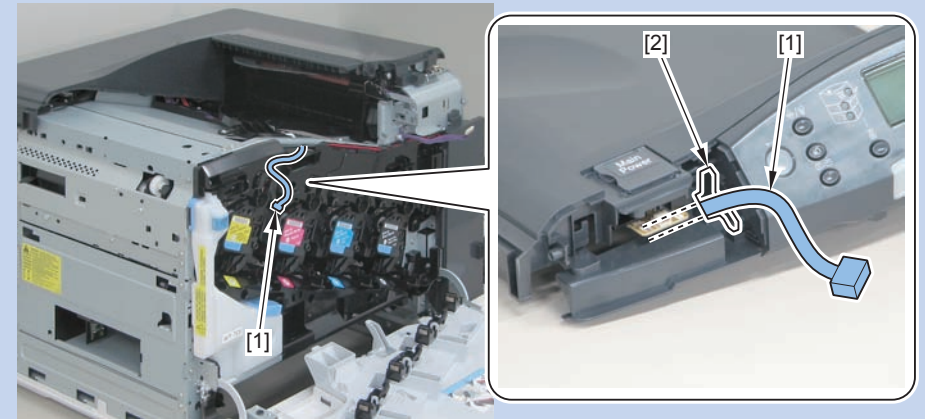

F-3-29

Removing Control Panel Unit

Before Removing Control Panel Unit

- 1) Remove the control panel unit right cover.(Refer to page 3-14)
- 2) Remove the left cover.(Refer to page 3-11)
- 3) Remove the control panel unit left cover.(Refer to page 3-15)
- 4) Remove the upper front cover unit.(Refer to page 3-16)

Removing Control Panel Unit

- 1) Remove the 2 screws [1].

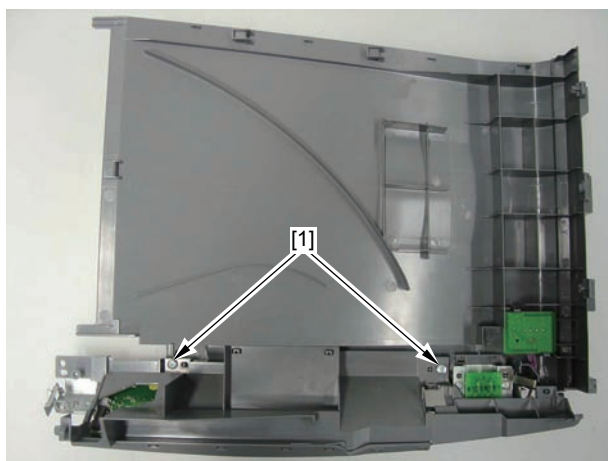

F-3-30

- 2) Remove the connector [1]

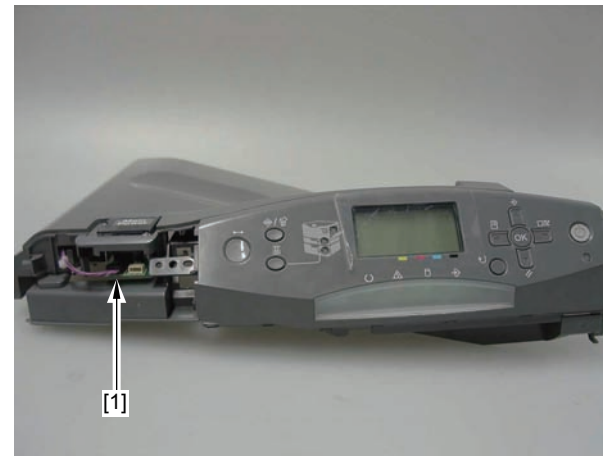

F-3-31

- 3) Remove the control panel unit [1].

- 4 claws [2]

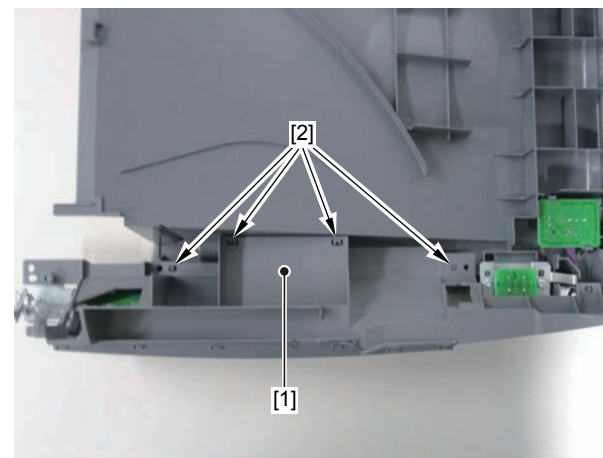

F-3-32

Removing Control Panel Unit(LBP7780C/LBP5480)

Before Removing Control Panel Unit

- 1) Remove the control panel unit right cover.(Refer to page 3-14)
- 2) Remove the left cover.(Refer to page 3-11)
- 3) Remove the control panel unit left cover.(Refer to page 3-15)
- 4) Remove the upper front cover unit.(Refer to page 3-16)

Removing Control Panel Unit

- 1) Remove the 2 screws [1].

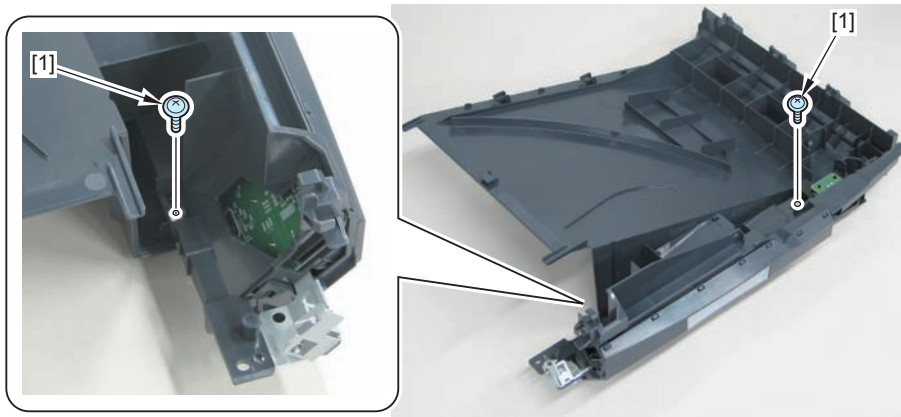

F-3-33

- 2) Remove the control panel unit [1].

- 4 claws [2]

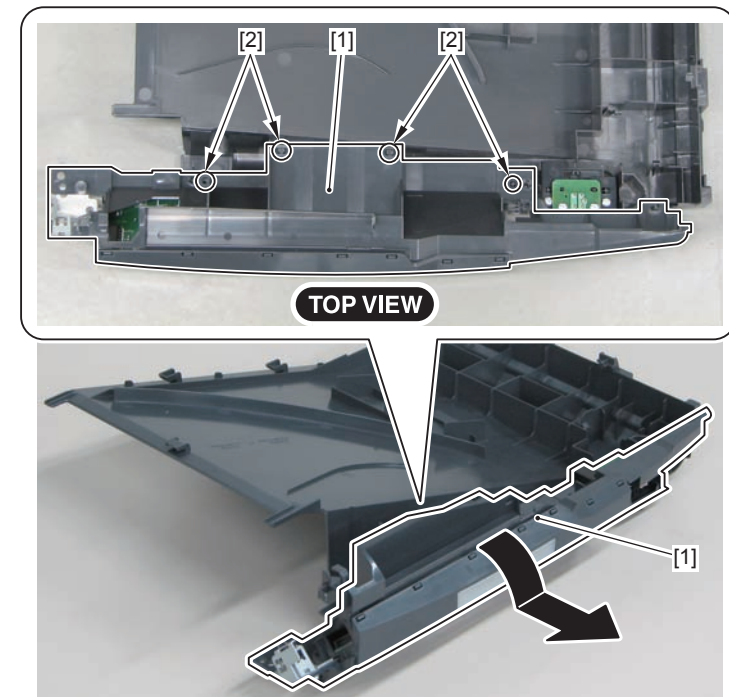

F-3-34

Removing Upper Rear Cover

Before Removing the Upper Rear Cover

- 1) Remove the rear cover.(Refer to page 3-12)
- 2) Remove the control panel unit right cover.(Refer to page 3-14)
- 3) Remove the left cover.(Refer to page 3-11)
- 4) Remove the control panel unit left cover.(Refer to page 3-15)
- 5) Remove the upper front cover unit.(Refer to page 3-16)

Removing Upper Rear Cover

- 1) Remove the upper rear cover [1] by sliding it to the direction of the arrow.
 - 2 screws [2]
 - 1 claw [3]
 - 1 boss [4]

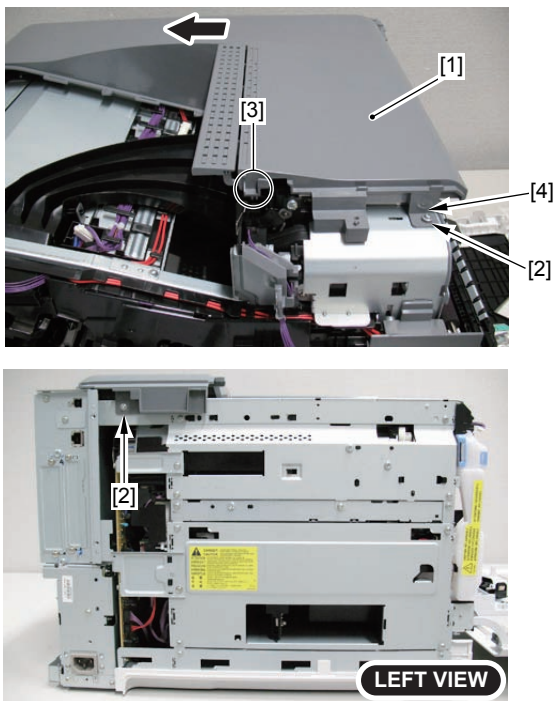

F-3-35

Removing Upper Rear Cover(LBP7780C/LBP5480)

Before Removing the Upper Rear Cover

- 1) Remove the rear cover(Refer to page 3-12)
- 2) Remove the control panel unit right cover.(Refer to page 3-14)
- 3) Remove the left cover.(Refer to page 3-11)
- 4) Remove the control panel unit left cover.(Refer to page 3-15)
- 5) Remove the upper front cover unit.(Refer to page 3-16)

Removing Upper Rear Cover

- 1) Remove the upper rear cover [1] by sliding it to the direction of the arrow.
 - 2 screws [2]
 - 1 claw [3]
 - 1 boss [4]
 - 4 hooks [5]

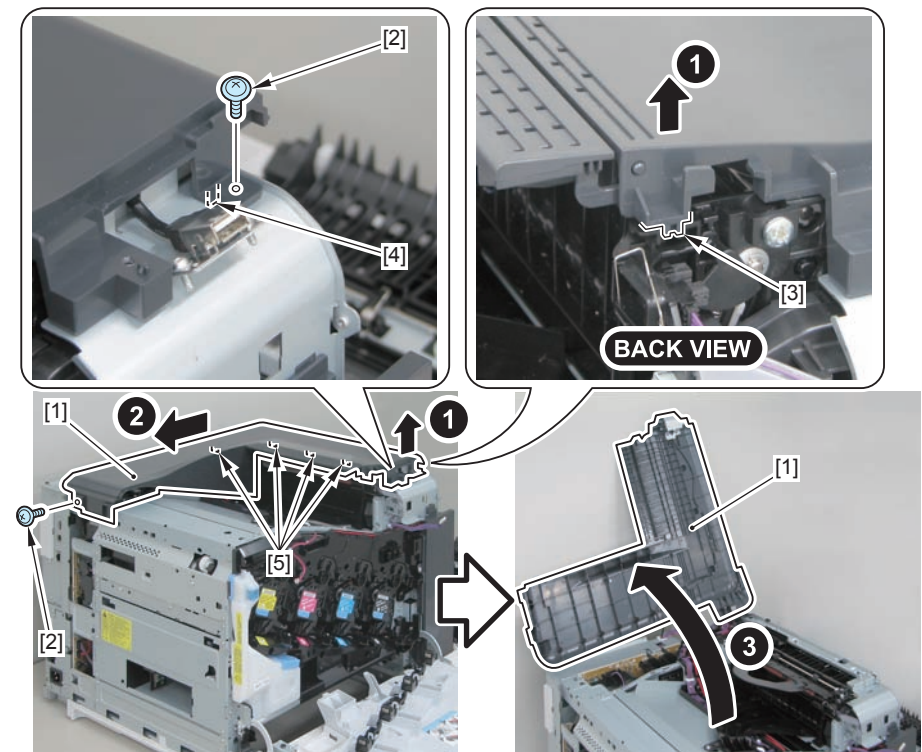

F-3-36

2) Remove the USB cable [1] and upper rear cover [2]

- 1 screw [3]
- 1 cable guide [4]

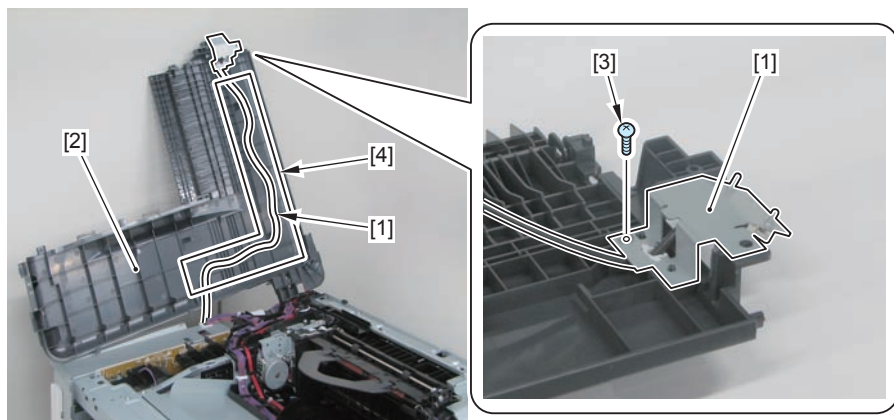

F-3-37

Removing the Front Cover Unit

- 1) Open the front cover unit.
 - 2) Remove the front cover unit [1].
- 2 screws [2]

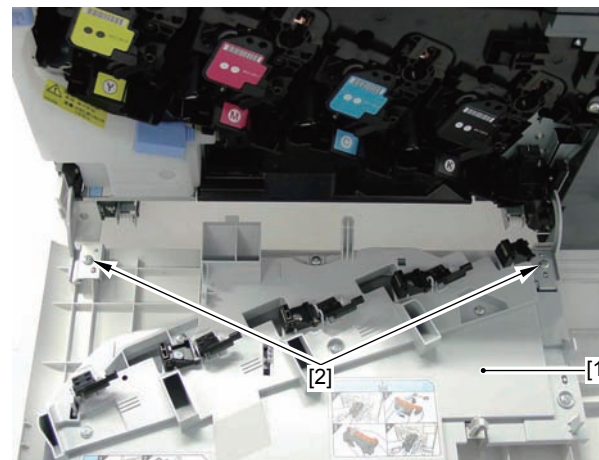

F-3-38

Removing Front Right Cover

Before Removing Front Right Cover

- 1) Open the right cover unit. (Refer to page 3-25)
- 2) Remove the control panel unit right cover. (Refer to page 3-14)

Removing Front Right Cover

- 1) Remove the screw [1].

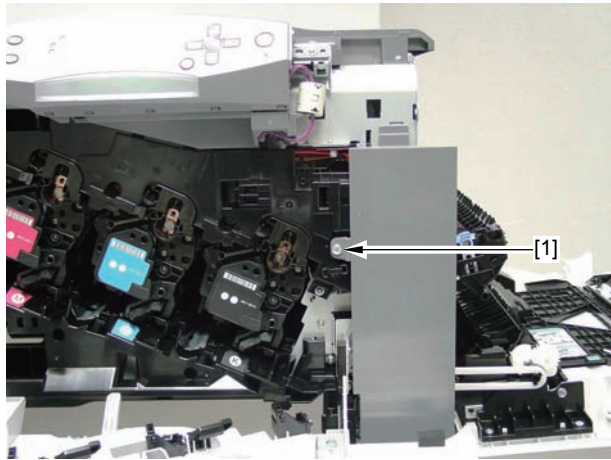

F-3-39

- 2) Remove the front right cover [1].

- 2 screws [2]
- 2 claws [3]
- 1 hook [4]

MEMO :

When removing the Front Right cover, make sure to remove the claw from the very bottom one and remove the top claw at the end.

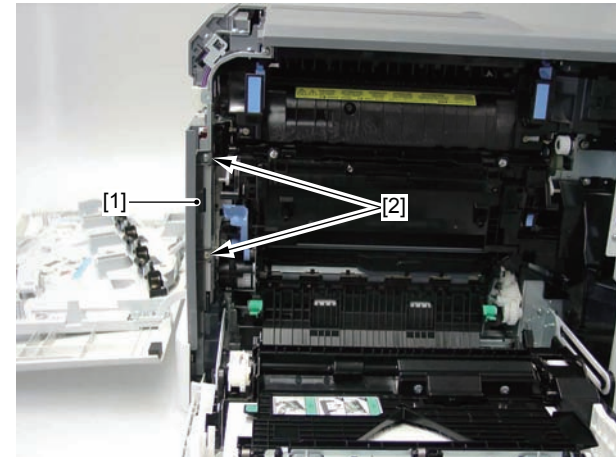

F-3-40

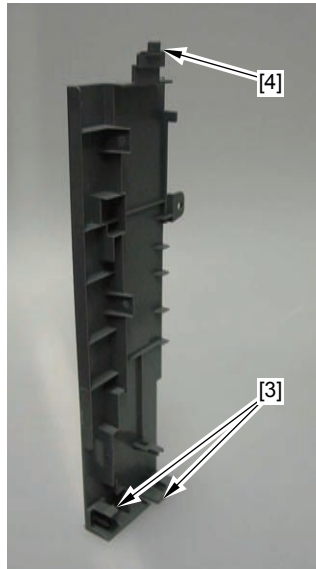

F-3-41

● Removing Front Right Cover(LBP7780C/LBP5480)

■ Before Removing Front Right Cover

- 1) Open the right cover unit.
- 2) Remove the control panel unit right cover.(Refer to page 3-14)
- 3) Remove the front cover unit(Refer to page 3-22)

■ Removing Front Right Cover

- 1) Remove the screw [1].

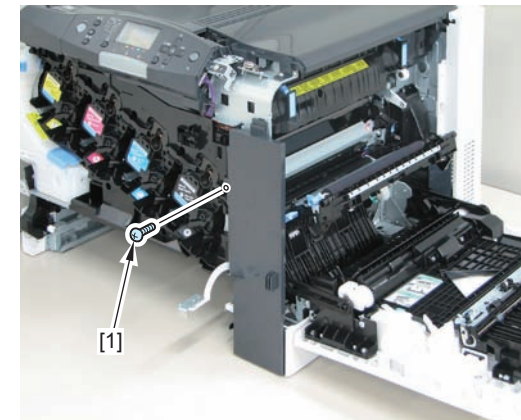

F-3-42

2) Remove the front right cover [1].

- 2 screws [2]
- 2 claws [3]
- 1 hook [4]

MEMO :

When removing the Front Right cover, make sure to remove the claw from the very bottom one and remove the top claw at the end.

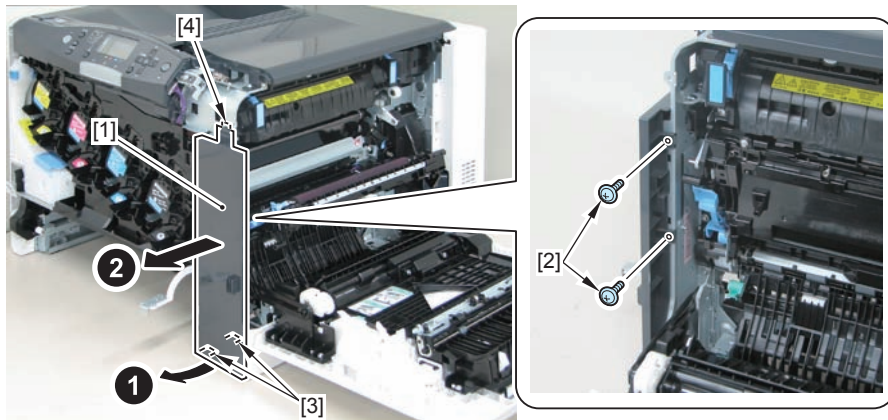

F-3-43

Removing the Right Cover Unit

1) Open the right cover unit.

2) Close the secondary transfer unit [1], and remove the cover [2].

- 3 screws [3]

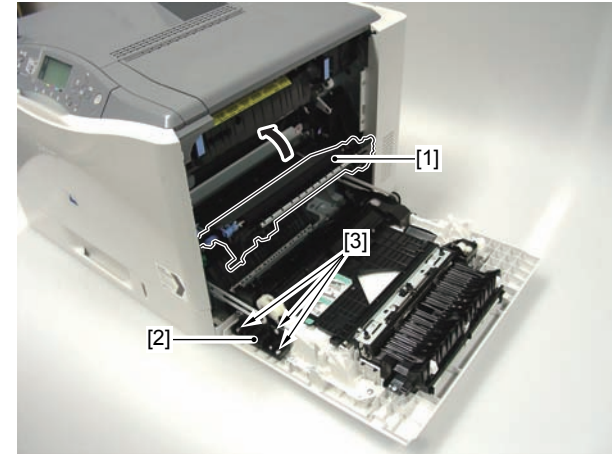

F-3-44

3) Remove the link arm [1], and remove the cover [2].

- 1 screw [3]

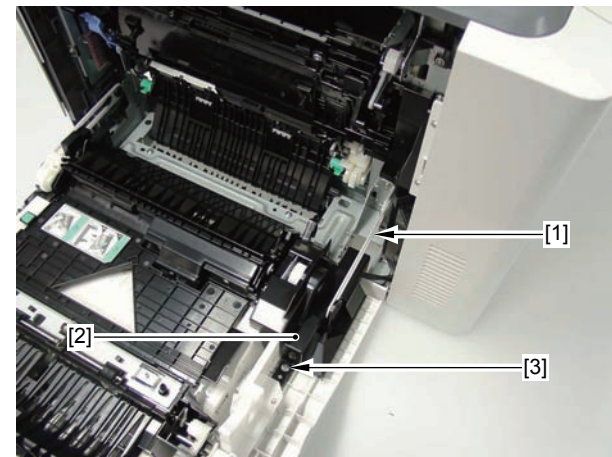

F-3-45

4) Remove the right cover unit [1].

- 2 screws [2]
- 2 connectors [3]

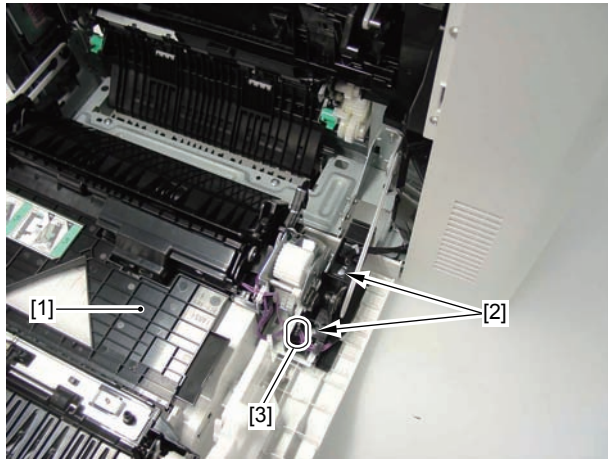

F-3-46

Removing the Right Cover Unit(LBP7780C/5480)

- 1) Open the right cover unit.
- 2) Close the secondary transfer unit [1], and remove the cover [2].
 - 3 screws [3]

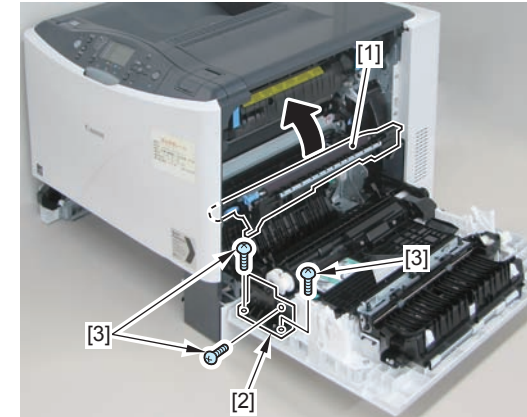

F-3-47

- 3) Remove the link arm [1], and remove the cover [2].
 - 1 screw [3]
 - 2 hooks [4]

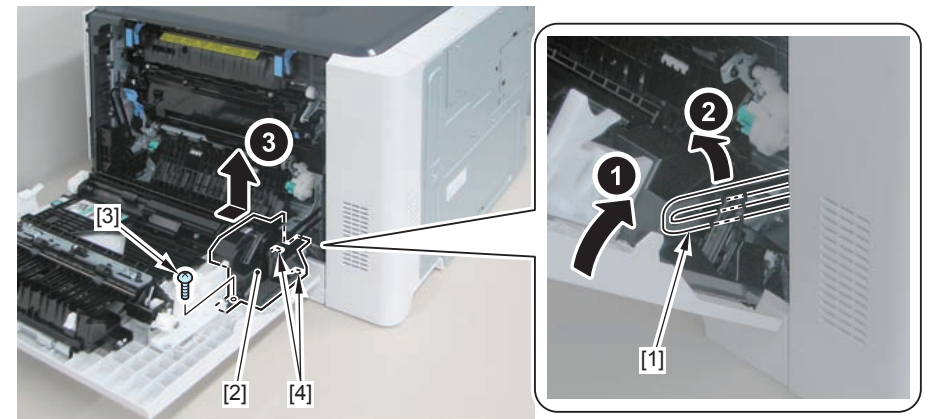

F-3-48

Main Units

Removing Secondary Transfer Unit

- 1) Open the right cover unit.
- 2) Press the arm [1] downward, and lift down the secondary transfer unit [2].

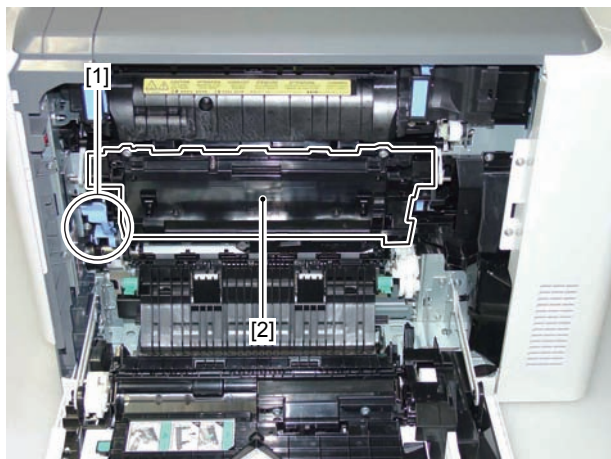

F-3-49

- 3) Push and remove the left shaft [1] to the right, and remove the Secondary Transfer Unit [2].

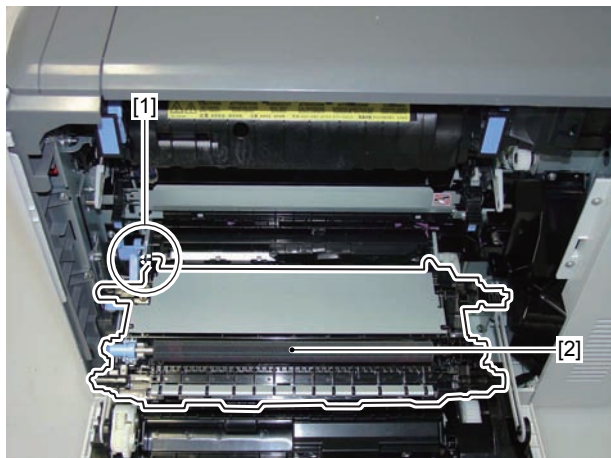

F-3-50

Removing ITB Unit

- 1) Open the right cover unit.
- 2) Press the arm [1] downward, and lift down the secondary transfer unit [2].

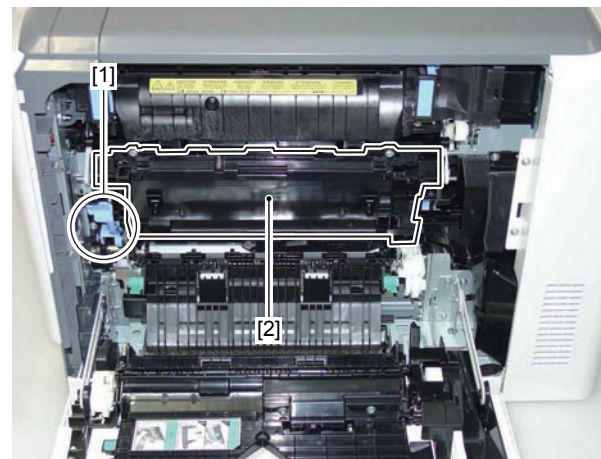

F-3-51

- 3) Hold the left and right grip [1], and pull out the ITB unit [2].

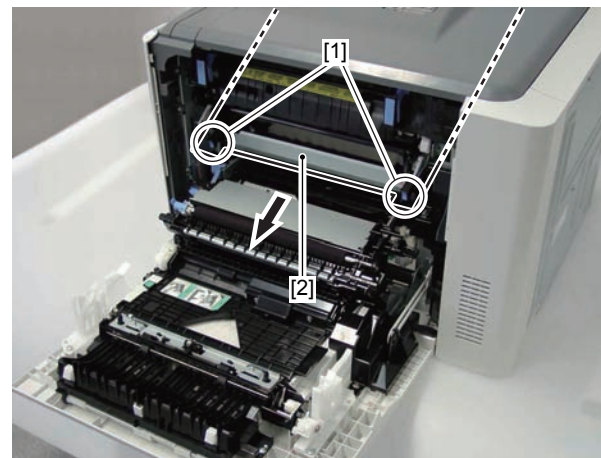

F-3-52

4) Pinch to the left and right grip [1], and remove the ITB unit [2].

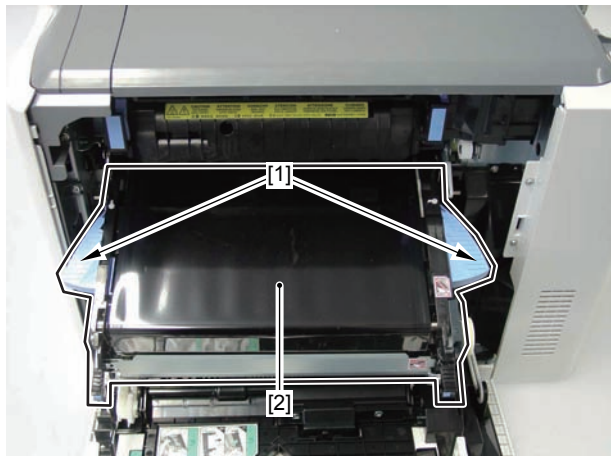

F-3-53

Caution :

Be sure not to touch the belt surface.



F-3-54

Removing Fixing Assembly

Caution :

Since the Fixing Assembly is in high temperature just after the power OFF, make sure to leave it until it cools down before remove it.

- 1) Open the right cover unit.
- 2) Hold the left&right grips [1] to release the lock and remove the Fixing Assembly [2].

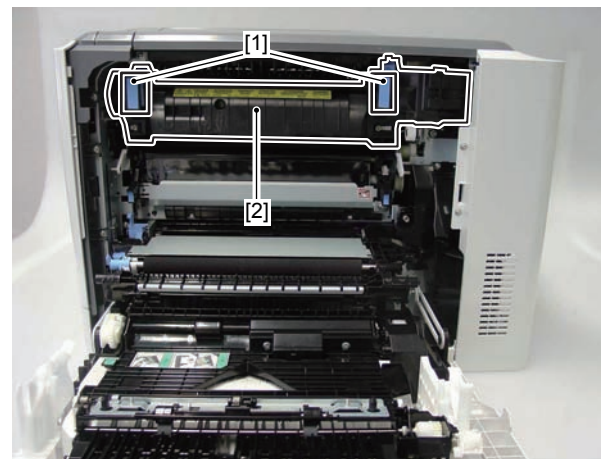

F-3-55

Removing Waste Toner Container

- 1) Open the front cover unit.
- 2) Remove the waste toner container [1].



F-3-56

Remove the Waste Toner Container(LBP7780C/ LBP5480)

- 1) Open the front cover unit.
- 2) Remove the waste toner container [1].

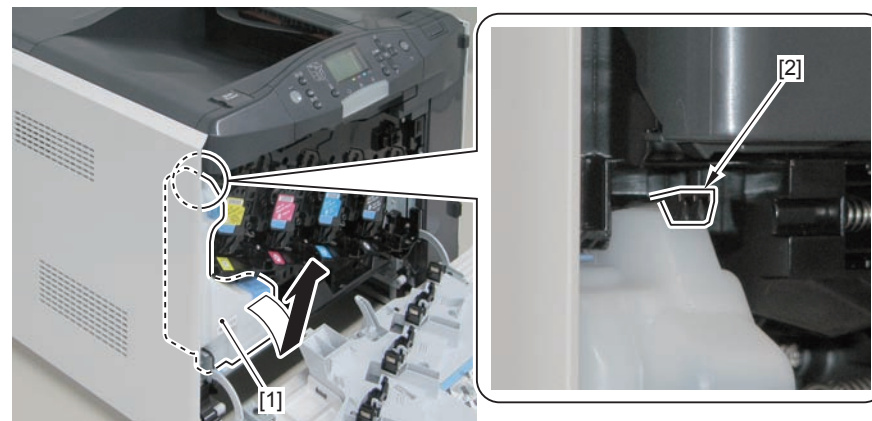

F-3-57

Removing Waste Toner Full Sensor Unit

Before Removing Waste Toner Full Sensor Unit

- 1) Remove the left cover. (Refer to page 3-11)
- 2) Remove the waste toner container. (Refer to page 3-29)

Removing the Waste Toner Full Sensor Unit

- 1) Remove the left plate cover [1].
 - 5 screws [2]

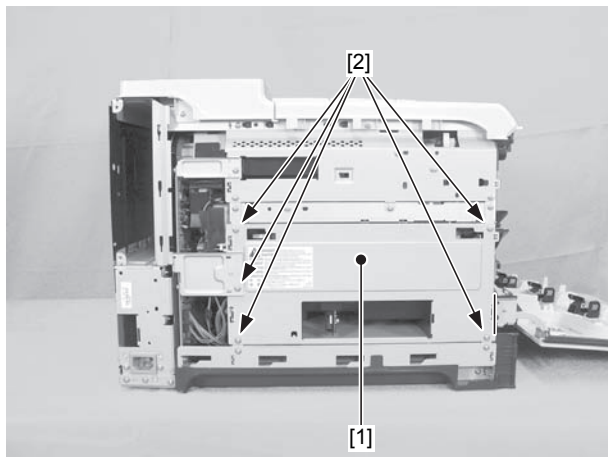

F-3-58

- 2) Remove the waste toner full sensor unit [1].

- 1 screw [2] (tapping screw)
- 1 connector [3]

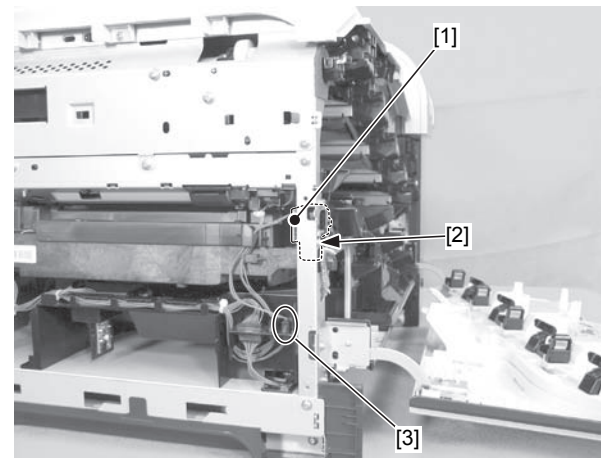

F-3-59

Points to note at installation :

When installing the Waste Toner Full Sensor Unit, hang the hook [1] and fix it with the screw [2].

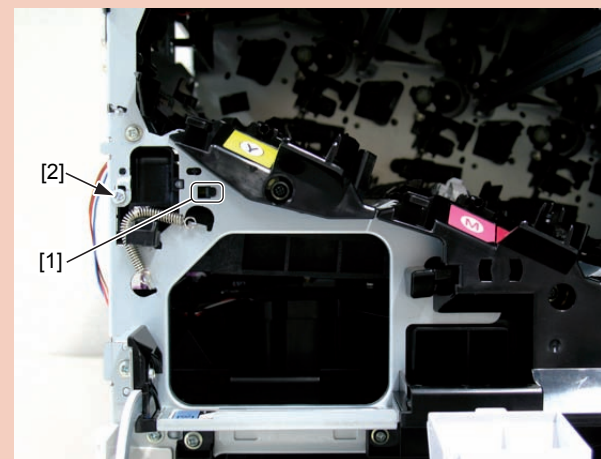

F-3-60

Removing Waste Toner Full Sensor Unit(LBP7780C/LBP5480)

Before Removing Waste Toner Full Sensor Unit

- 1) Remove the left cover.(Refer to page 3-11)
- 2) Remove the waste toner container.(Refer to page 3-29)

Removing the Waste Toner Full Sensor Unit

- 1) Remove the left plate cover [1].
 - 5 screws [2]

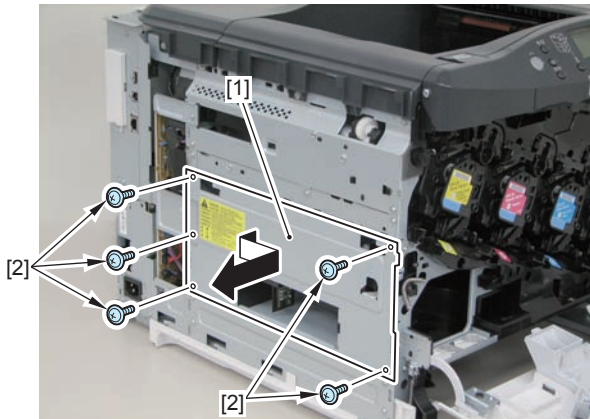

F-3-61

- 2) Remove the waste toner full sensor unit [1].

- 1 screw [2] (tapping screw)
- 1 connector [3]

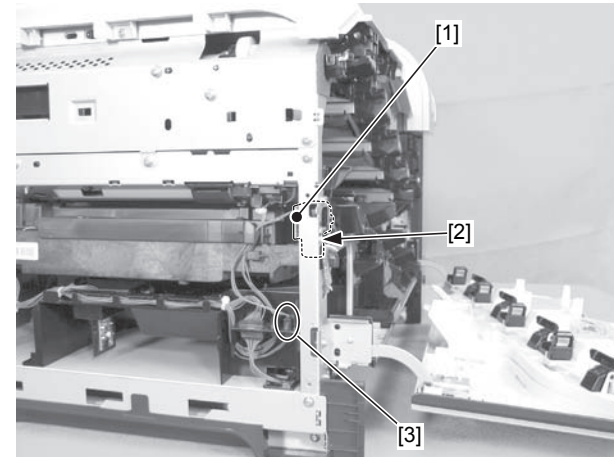

F-3-62

Points to note at installation :

When installing the Waste Toner Full Sensor Unit, hang the hook [1] and fix it with the screw [2].

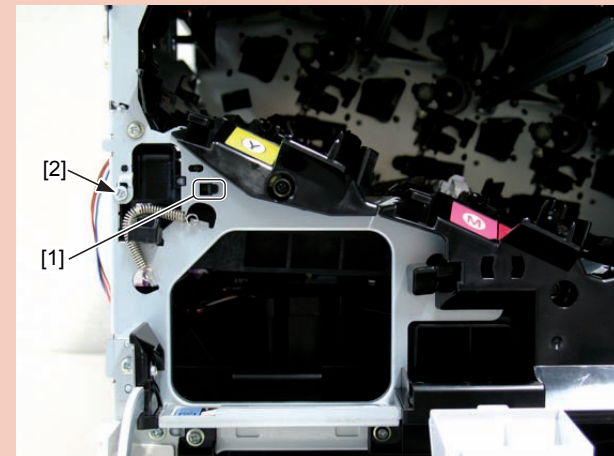

F-3-63

Removing Waste Toner Feed Motor Unit

Before Removing Waste Toner Feed Motor Unit

- 1) Remove the left cover. (Refer to page 3-11)
- 2) Remove the waste toner container. (Refer to page 3-29)

Removing Waste Toner Feed Motor Unit

- 1) Remove the toner cartridge.
- 2) Remove the connector cover [1].
 - 1 claw [2]

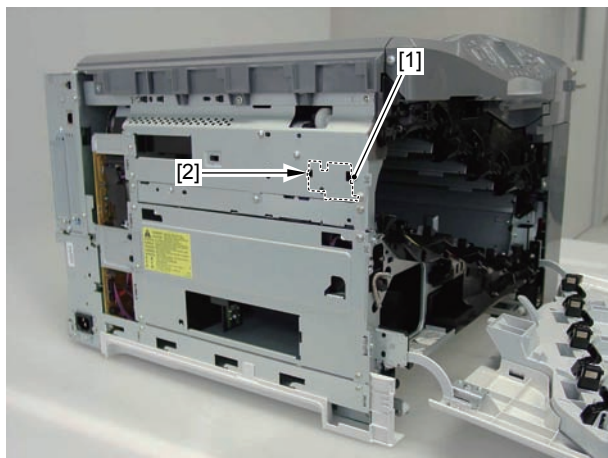

F-3-64

- 3) Remove 1 connector [1].

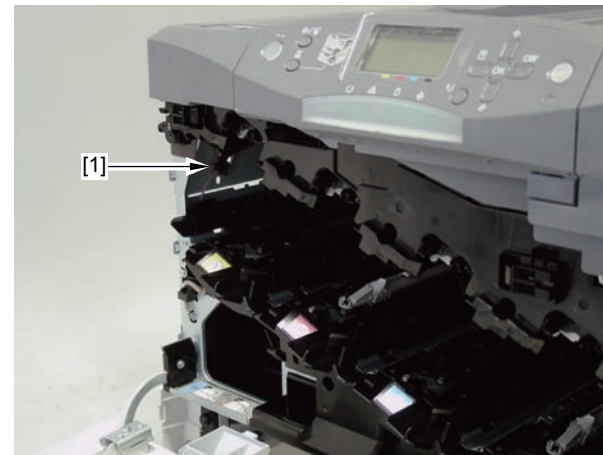

F-3-65

- 4) Remove the waste toner feed motor unit [1].
 - 2 screws [2]

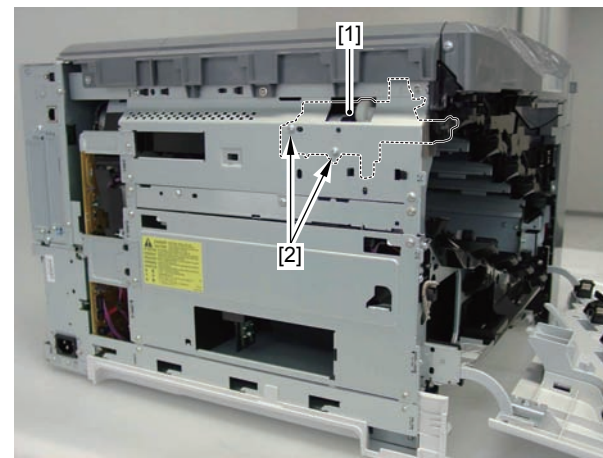

F-3-66

Removing Waste Toner Feed Motor Unit(LBP7780C/ LBP5480)

Before Removing Waste Toner Feed Motor Unit

- 1) Remove the left cover.(Refer to page 3-11)
- 2) Remove the waste toner container.(Refer to page 3-29)

Removing Waste Toner Feed Motor Unit

- 1) Remove the toner cartridge.
- 2) Remove the connector cover [1].
 - 1 claw [2]

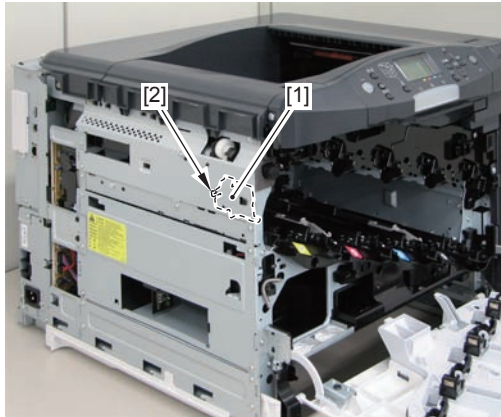

F-3-67

- 3) Remove 1 connector [1].

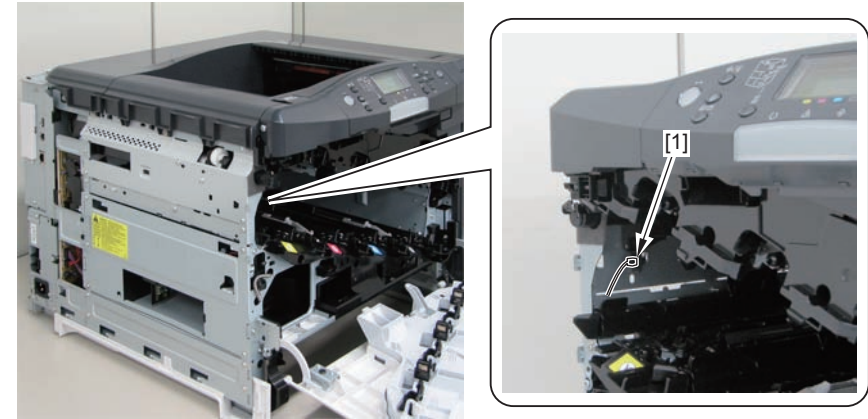

F-3-68

- 4) Remove the waste toner feed motor unit [1].
 - 2 screws [2]

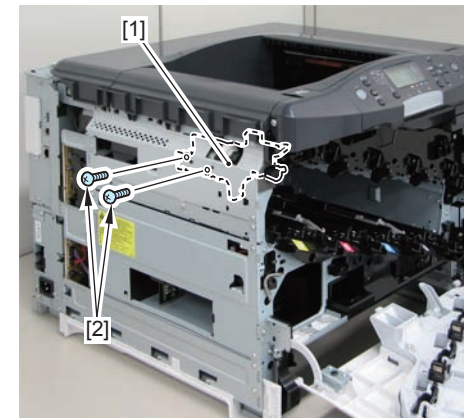

F-3-69

Removing Registration Unit

Before Removing Registration Unit

- 1) Remove the secondary transfer unit. (Refer to page 3-27)
- 2) Remove the left cover. (Refer to page 3-11)
- 3) Remove the rear cover. (Refer to page 3-12)
- 4) Remove the right rear cover. (Refer to page 3-13)
- 5) Remove the Power Fan. (Refer to page 3-79)

Removing Registration Unit

- 1) Remove the gear cover [1].
 - 2 screws [2]

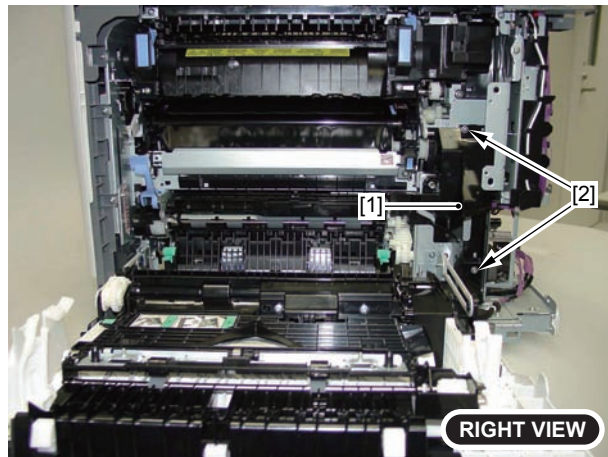

F-3-70

- 2) Remove the of the DC controller PCB.

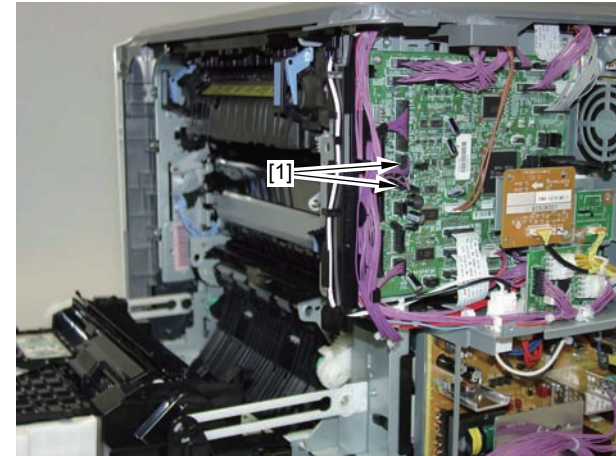

F-3-71

- 3) Remove the cover [1].
 - 1 screw [2]

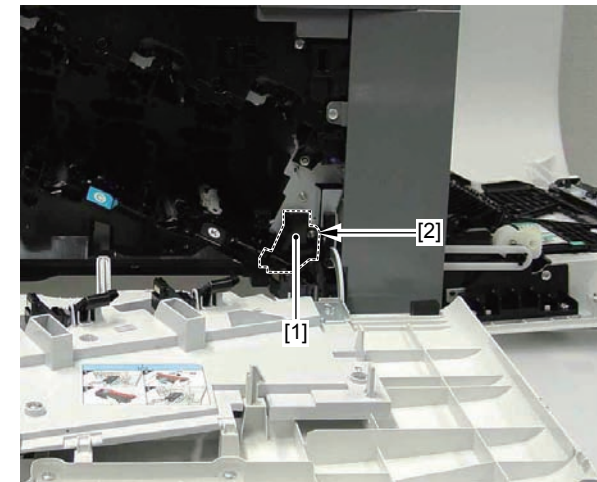

F-3-72

4) Open the feed guide [1].

- 2 claws [2]

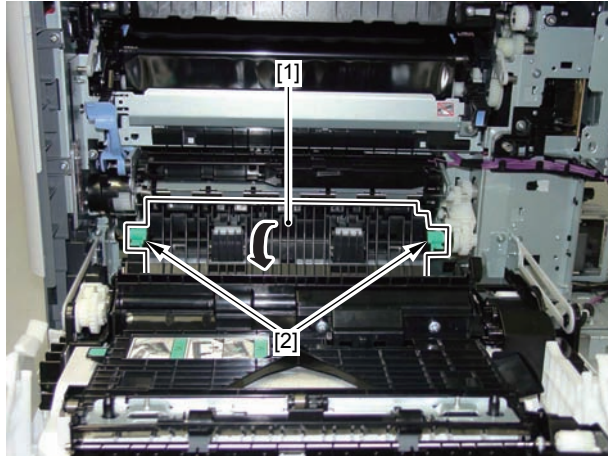

F-3-73

Caution :

At assembly, close the Feed Guide [1] and hook the 2 claws [2] securely.

5) Remove the registration unit [1] by lifting it up.

- 3 screws [2]
- 2 hooks [3]

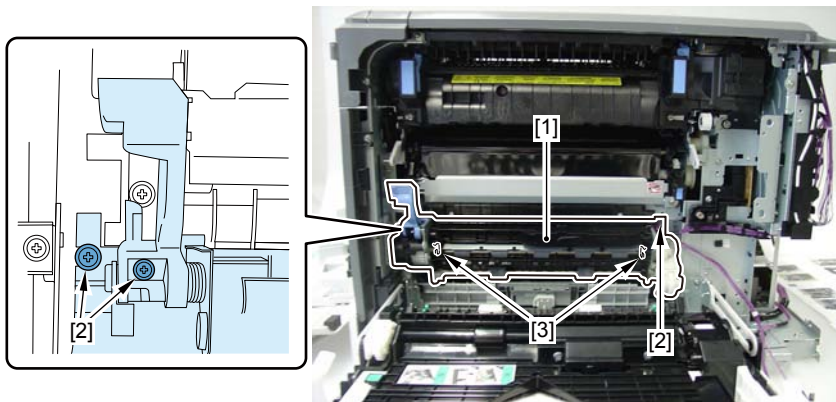

F-3-74

Removing Registration Unit(LBP7780C/LBP5480)

Before Removing Registration Unit

- 1) Remove the secondary transfer unit. (Refer to page 3-27)
- 2) Remove the left cover. (Refer to page 3-11)
- 3) Remove the right rear cover. (Refer to page 3-13)
- 4) Remove the rear cover. (Refer to page 3-12)
- 5) Remove the Power Fan. (Refer to page 3-79)

Removing Registration Unit

- 1) Remove the gear cover [1].
- 2 screws [2]

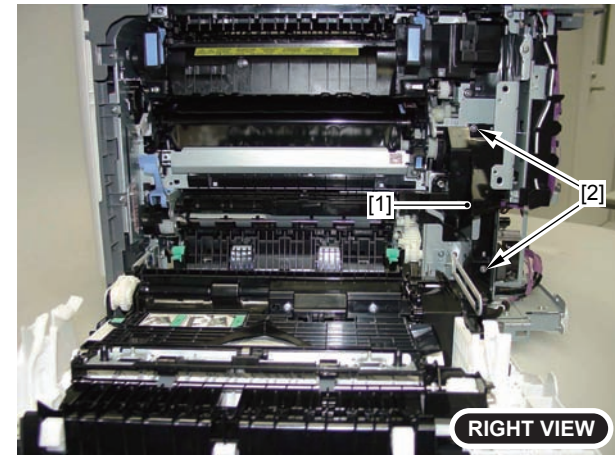

F-3-75

2) Remove the 2 connectors [1] from the DC controller PCB.

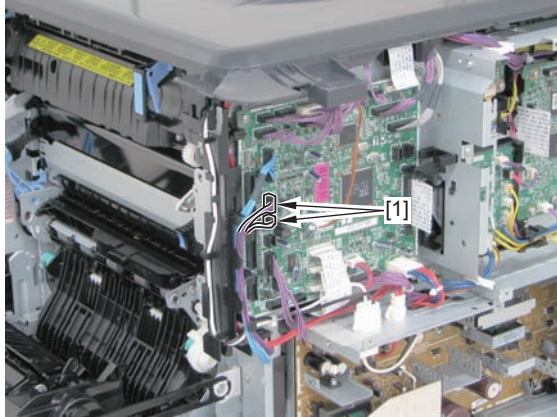

F-3-76

3) Remove the cover [1].

- 1 screw [2]
- 1 hook [3]

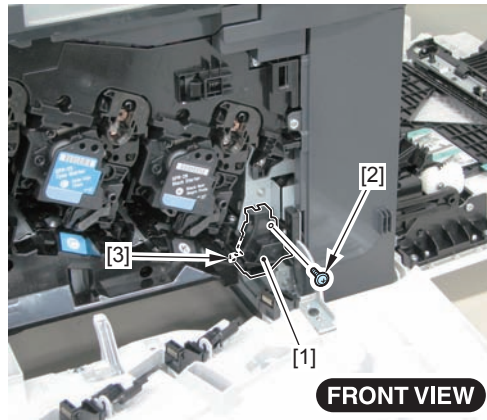

F-3-77

4) Open the feed guide [1].

- 2 claws [2]

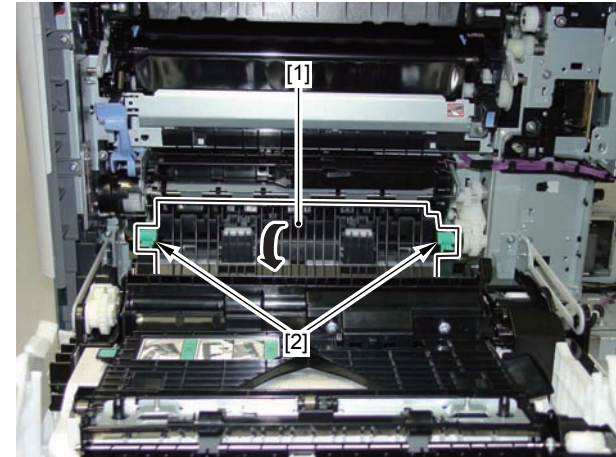

F-3-78

Caution :

At assembly, close the Feed Guide [1] and hook the 2 claws [2] securely.

5) Remove the registration unit [1] by lifting it up.

- 3 screws [2]
- 2 hooks [3]

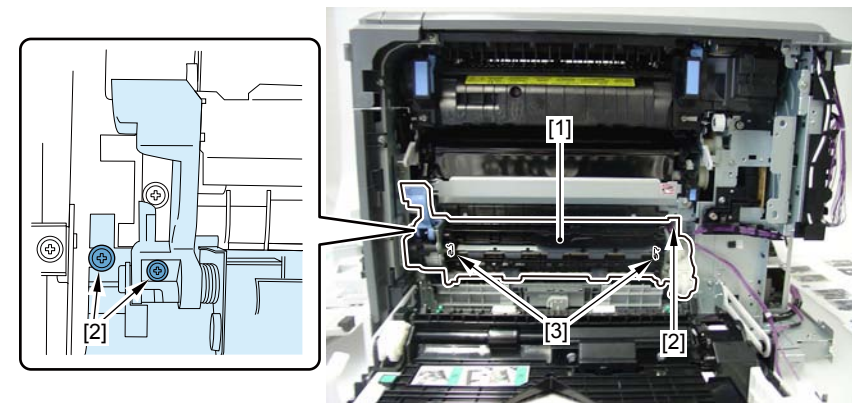

F-3-79

Removing Color Displacement/Density Sensor Unit

Before Removing Color Displacement/Density Sensor Unit

- 1) Remove the secondary transfer unit. (Refer to page 3-27)
- 2) Remove the ITB unit. (Refer to page 3-27)
- 3) Remove the left cover. (Refer to page 3-11)
- 4) Remove the rear cover. (Refer to page 3-12)
- 5) Remove the right rear cover. (Refer to page 3-13)
- 6) Remove the power fan. (Refer to page 3-79)

Removing Color Displacement/Density Sensor Unit

- 1) Remove the connector [1] on the DC controller in 1 place.

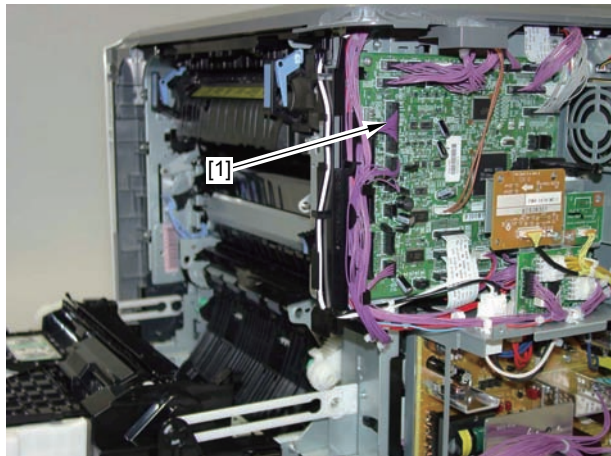

F-3-80

- 2) Remove the harness from the harness guide [1], and remove the color displacement/density sensor unit [2].

- 2 screws [3]
- Slide the shutter [4] to the rear.

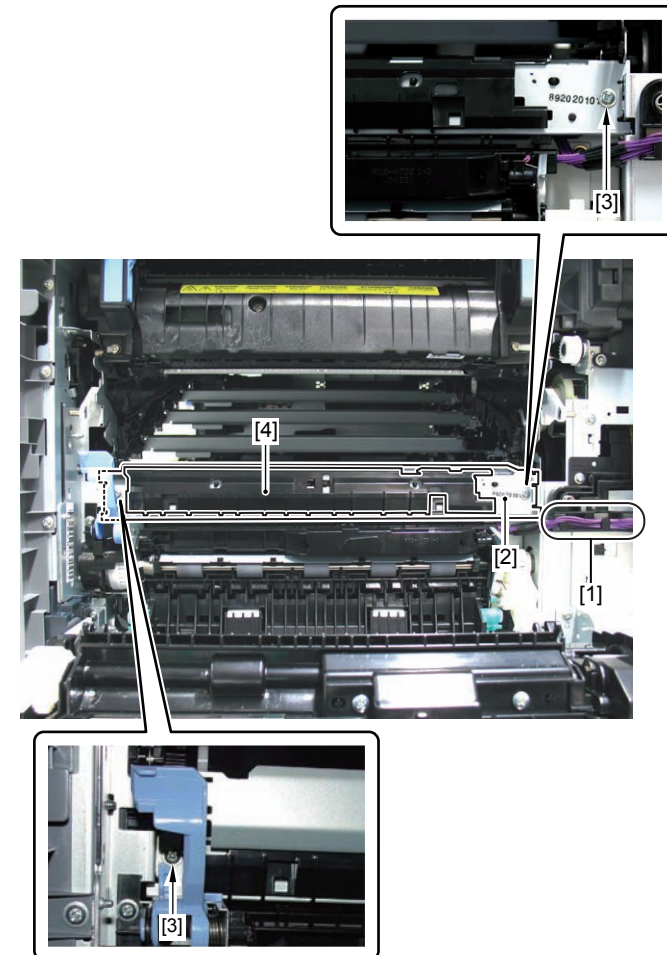

F-3-81

Points to note at installation :

Make sure to keep the shutter slid when installing the Color Displacement/Density Sensor Unit to the host machine.

Removing Color Displacement/Density Sensor Unit(LBP7780C/5480)

Before Removing Color Displacement/Density Sensor Unit

- 1) Remove the secondary transfer unit. (Refer to page 3-27)
- 2) Remove the ITB unit. (Refer to page 3-27)
- 3) Remove the left cover. (Refer to page 3-11)
- 4) Remove the right rear cover. (Refer to page 3-13)
- 5) Remove the rear cover. (Refer to page 3-12)
- 6) Remove the power fan. (Refer to page 3-79)

Removing Color Displacement/Density Sensor Unit

- 1) Remove the connector [1] on the DC controller in 1 place.

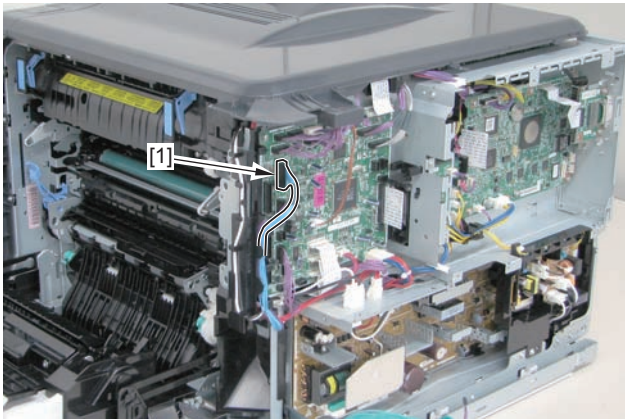

F-3-82

- 2) Remove the gear cover [1]

- 2 screws [2]

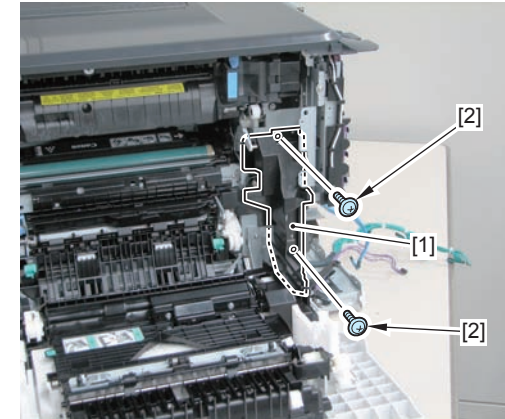

F-3-83

Removing Lifter Drive Unit

Before Removing Lifter Drive Unit

- 1) Remove the left cover. (Refer to page 3-11)
- 2) Remove the rear cover. (Refer to page 3-12)
- 3) Remove the right rear cover. (Refer to page 3-13)
- 4) Remove the ICB PCB. (Refer to page 3-101)
- 5) Remove the main controller PCB. (Refer to page 3-101)
- 6) Remove the low-voltage power unit. (Refer to page 3-109)
- 7) Remove the lower high voltage power supply PCB. (Refer to page 3-115)

Removing Lifter Drive Unit

- 1) Remove the harness [2] from the harness guide [1].
 - 3 connectors [3]

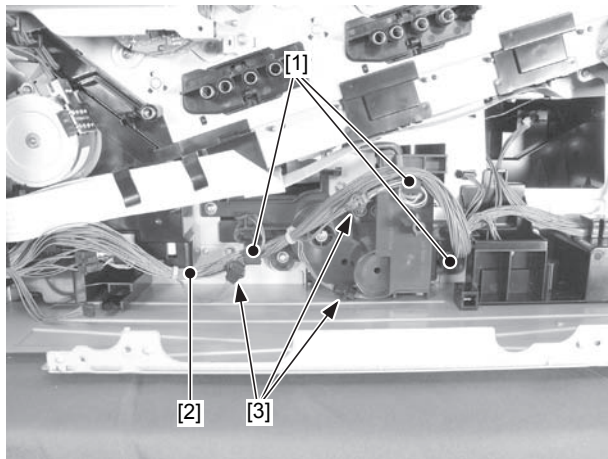

F-3-84

- 2) Remove the lifter drive unit [1].

- 5 screws [2]
- 1 claw [3]

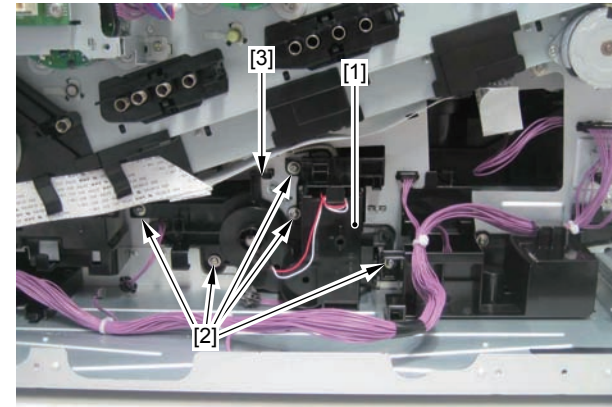

F-3-85

Removing Lifter Drive Unit(LBP7780C/LBP5480)

Before Removing Lifter Drive Unit

- 1) Remove the left cover.(Refer to page 3-11)
- 2) Remove the rear cover.(Refer to page 3-12)
- 3) Remove the right rear cover.(Refer to page 3-13)
- 4) Remove the main controller PCB.(Refer to page 3-101)
- 5) Remove the low-voltage power unit.(Refer to page 3-109)
- 6) Remove the lower high voltage power supply PCB.(Refer to page 3-115)

Removing Lifter Drive Unit

- 1) Remove the harness [2] from the harness guide [1].
 - 4 connectors [3]

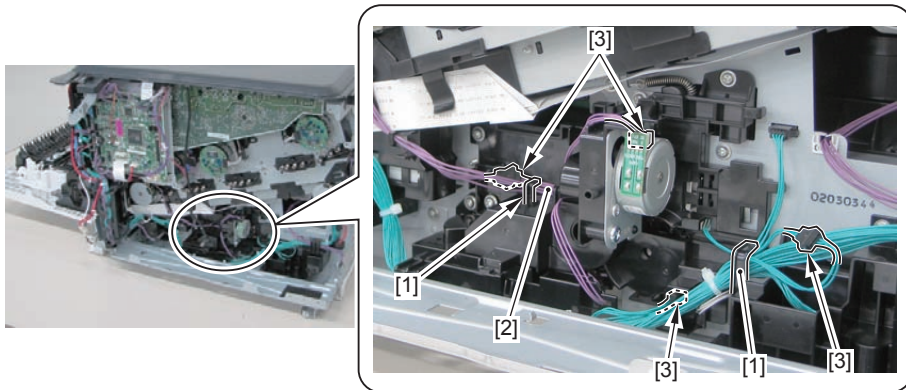

F-3-86

- 2) Remove the lifter drive unit [1].

- 5 screws [2]
- 1 claw [3]

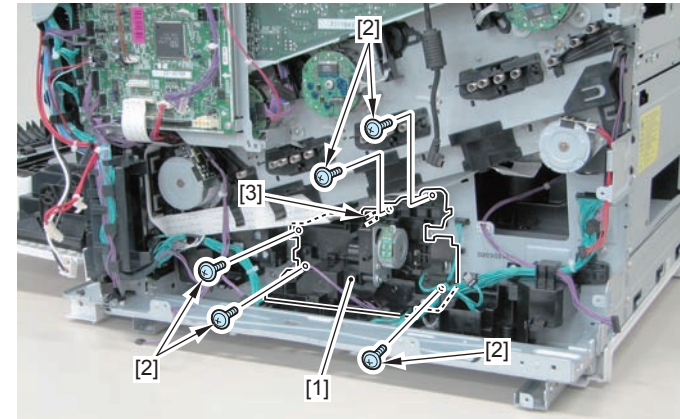

F-3-87

Removing Laser Scanner Unit

Before Removing Laser Scanner Unit

- 1) Remove the left cover. (Refer to page 3-11)
- 2) Remove the rear cover. (Refer to page 3-12)
- 3) Remove the right rear cover. (Refer to page 3-13)
- 4) Remove the ICB PCB. (Refer to page 3-101)
- 5) Remove the main controller PCB. (Refer to page 3-101)
- 6) Remove the low-voltage power unit. (Refer to page 3-109)
- 7) Remove the lower high voltage power supply PCB. (Refer to page 3-115)
- 8) Remove the fan unit. (Refer to page 3-82)
- 9) Remove the waste toner container. (Refer to page 3-29)
- 10) Remove the waste toner full sensor unit. (Refer to page 3-30)
- 11) Remove the toner cartridge.

Removing Y/M Laser Scanner Unit

- 1) Remove the harness guide [2] after removing the harness [1].
 - 1 connectors [3]
 - 1 claw [4]

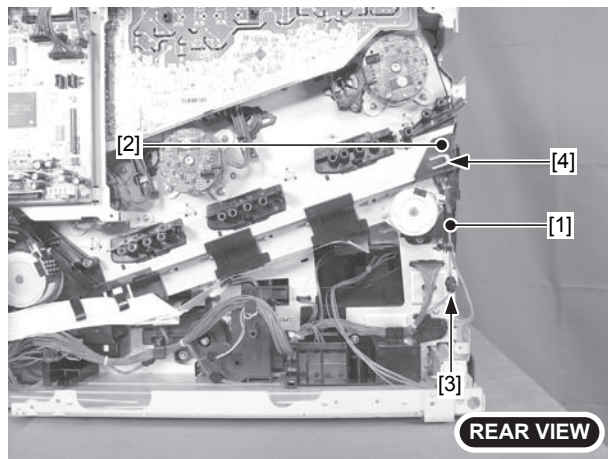

F-3-88

- 2) Remove the cover [1].
 - 1 screw [2]

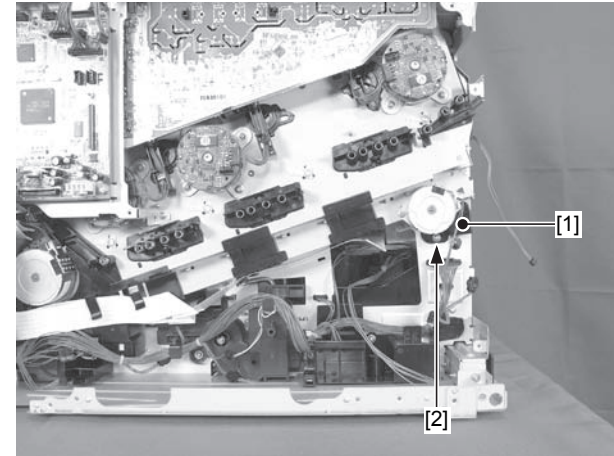

F-3-89

- 3) Remove the flat cable [1] and the spring [2].

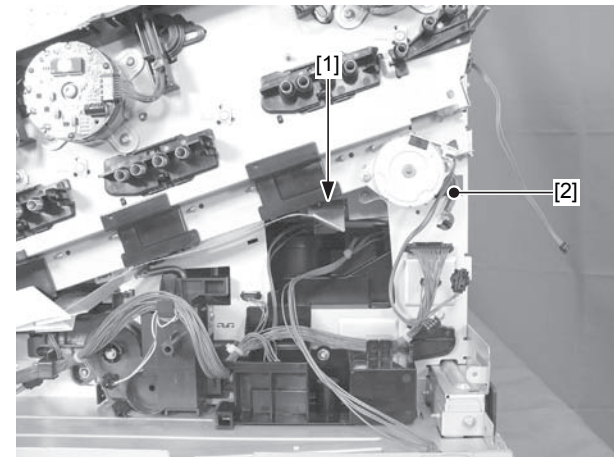

F-3-90

4) Pull out and slide the Y/M Laser Scanner Unit [1] to the right and remove the left shaft [2] to remove the unit.

- 1 spring [3]
- 1 connector [4]

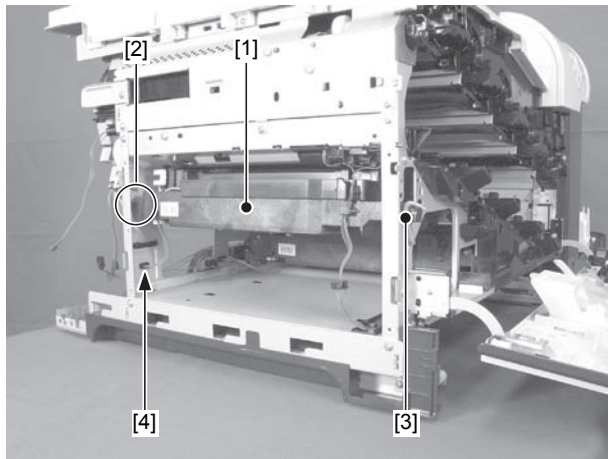

F-3-91

Caution :

Since adjustment is required for the Scanner Unit, do not disassemble it.

Points to note at installation :

Make sure to adjust the position by inserting the protrusion [1] of Laser Scanner Unit into the frame hole [2].

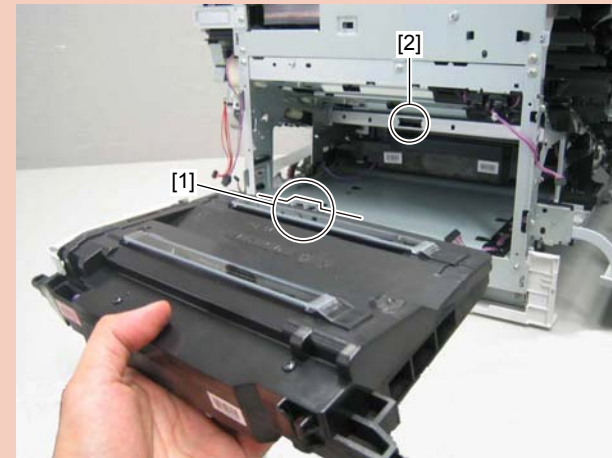

F-3-92

Removing C/Bk Laser Scanner Unit

- 1) Remove the Y/M laser scanner unit.
- 2) Remove the lifter drive unit.
- 3) Remove the spring [1] and the flat cable.[2].

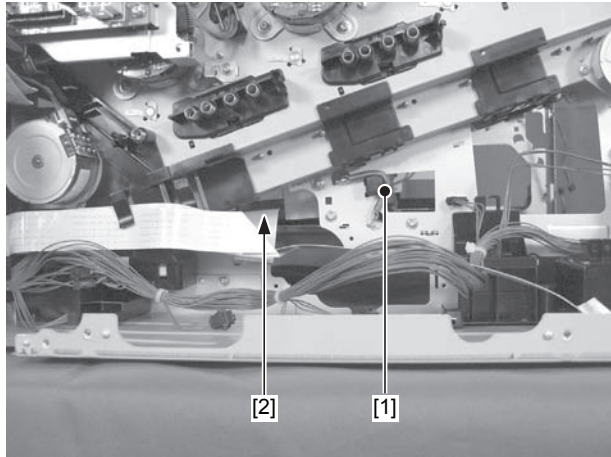

F-3-93

- 4) Remove the 2 screws [1] under the front cover unit.

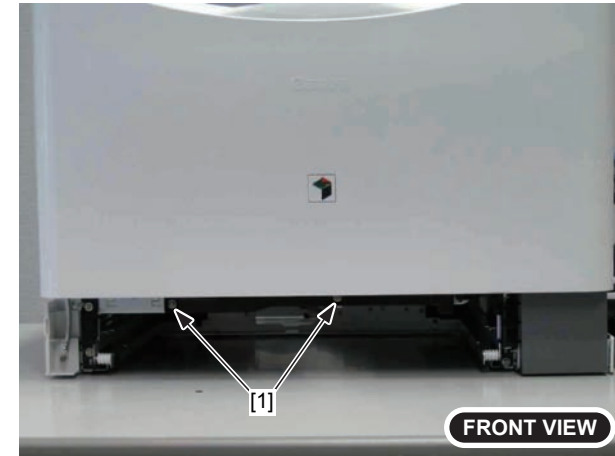

F-3-94

- 5) Open the front cover unit, and remove the cover [1].
 - 1 screw [2]

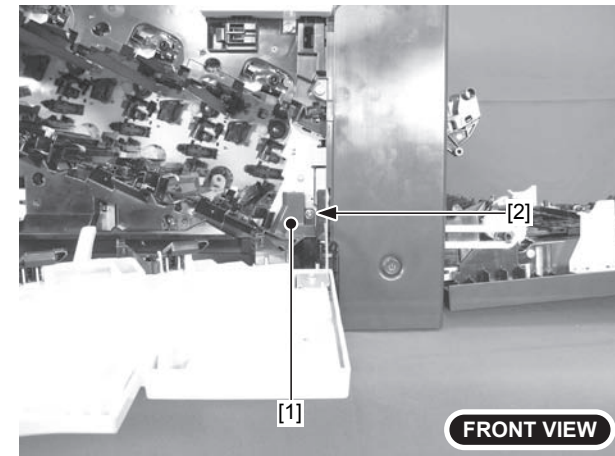

F-3-95

6) Remove the cover [1].

- 2 screws [2]
- 1 claw [3]

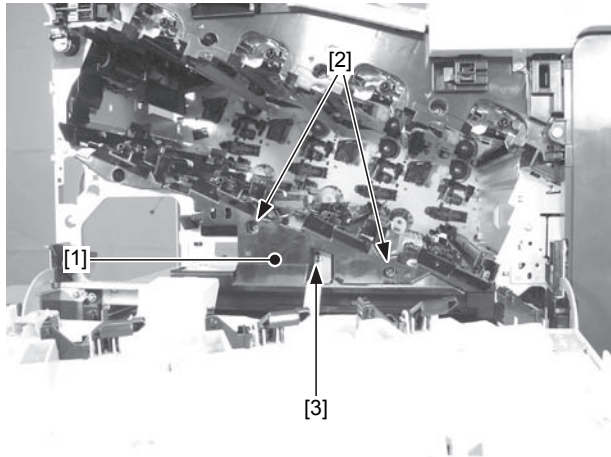

F-3-96

Caution :

When removing/installing the cover [1], be careful of the arm [2] because it easily comes off.

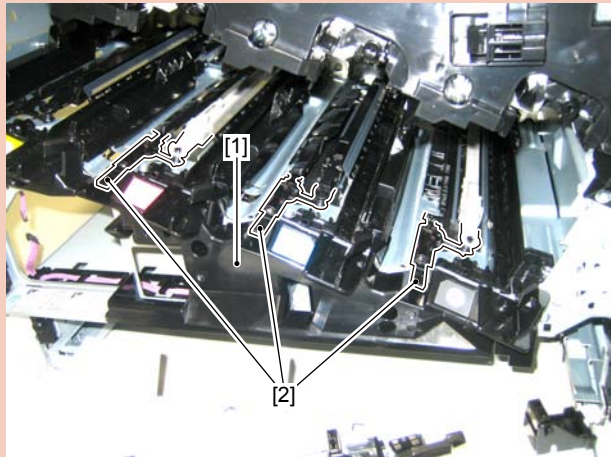

F-3-97

7) Remove the spring [1].

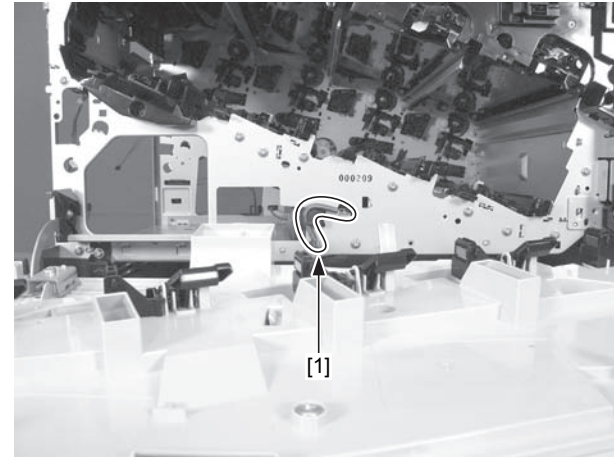

F-3-98

8) Remove the shaft [1] in the left side, remove the C/Bk scanner unit [2].

- 1 connector [3]

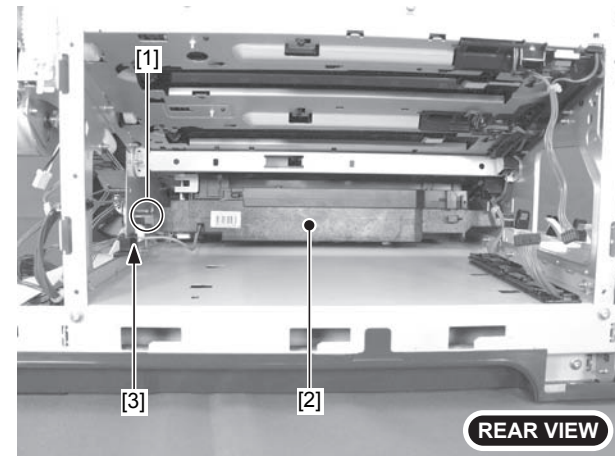

F-3-99

Points to note at installation :

- Make sure to adjust the position by inserting the protrusion [1] of Laser Scanner Unit into the frame hole [2].

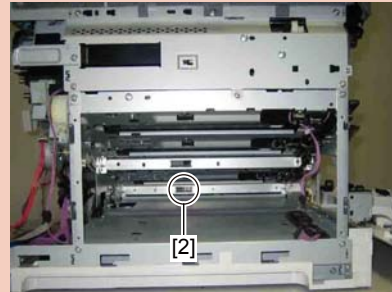
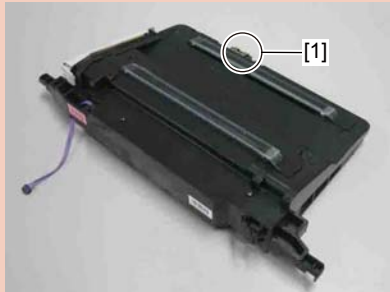

F-3-100

- When installing the cover, put the arm [1] through the cover hole [2].

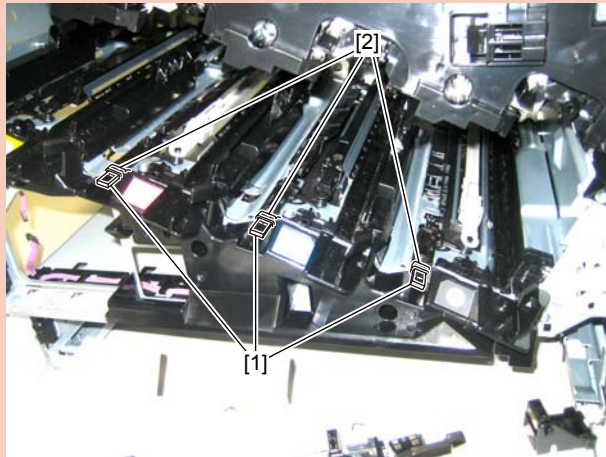

F-3-101

Removing Laser Scanner Unit(LBP7780C/LBP5480)

Before Removing Laser Scanner Unit

- 1) Remove the left cover.(Refer to page 3-11)
- 2) Remove the rear cover.(Refer to page 3-12)
- 3) Remove the right rear cover.(Refer to page 3-13)
- 4) Remove the main controller PCB.(Refer to page 3-101)
- 5) Remove the low-voltage power unit.(Refer to page 3-109)
- 6) Remove the lower high voltage power supply PCB.(Refer to page 3-115)
- 7) Remove the fan unit.(Refer to page 3-82)
- 8) Remove the waste toner container.(Refer to page 3-29)
- 9) Remove the waste toner full sensor unit.(Refer to page 3-30)
- 10) Remove the toner cartridge.

Removing Y/M Laser Scanner Unit

- 1) Remove the harness guide [2] after removing the harness [1].
 - 1 connectors [3]
 - 1 claw [4]

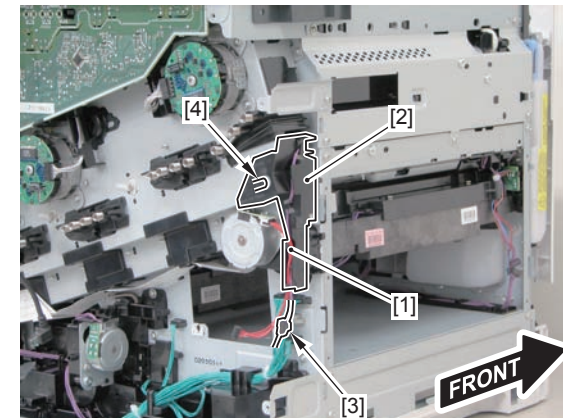

F-3-102

2) Remove the cover [1].

- 1 screw [2]

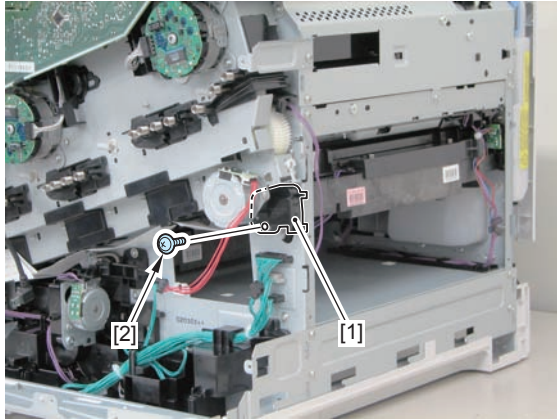

F-3-103

3) Remove the flat cable [1] and the spring [2].

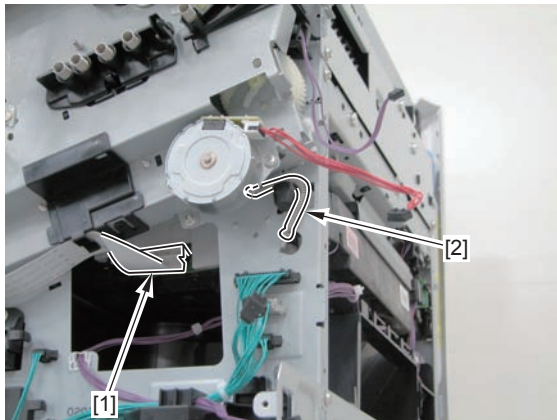

F-3-104

4) Pull out and slide the Y/M Laser Scanner Unit [1] to the right and remove the left shaft [2] to remove the unit.

- 1 spring [3]
- 1 connector [4]

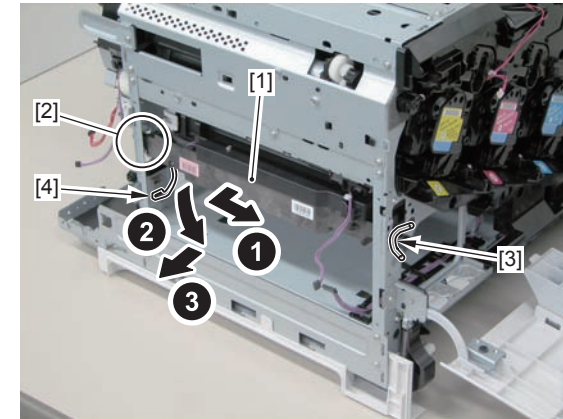

F-3-105

Caution :

Since adjustment is required for the Scanner Unit, do not disassemble it.

Points to note at installation :

Make sure to adjust the position by inserting the protrusion [1] of Laser Scanner Unit into the frame hole [2].

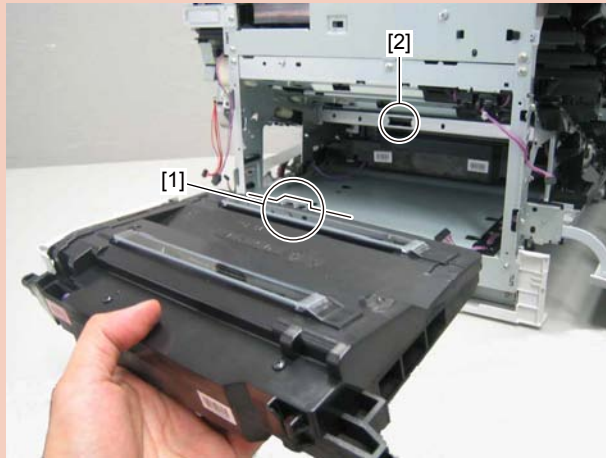

F-3-106

■ Removing C/Bk Laser Scanner Unit

- 1) Remove the Y/M laser scanner unit.
- 2) Remove the lifter drive unit.
- 3) Remove the spring [1] and the flat cable.[2].

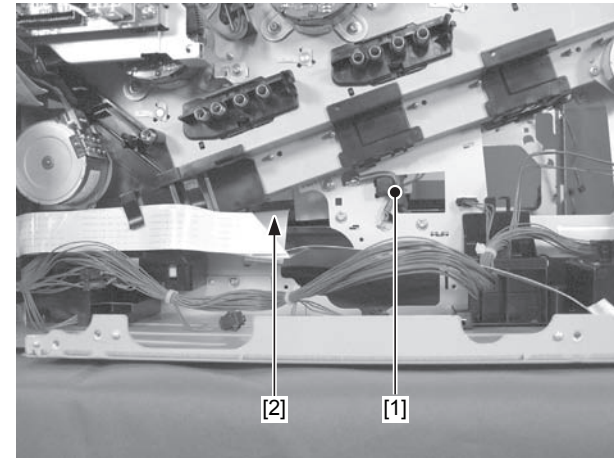

F-3-107

- 4) Remove the 2 screws [1] under the front cover unit.

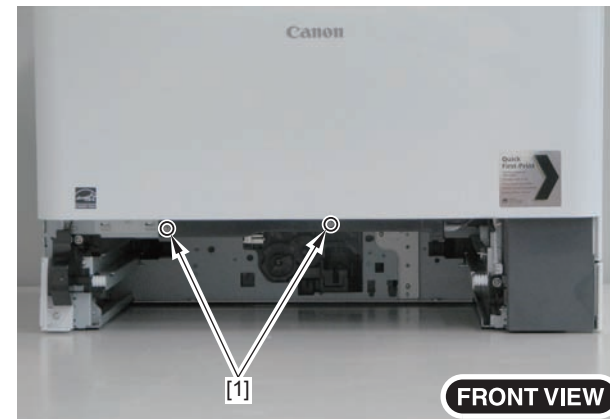

F-3-108

5) Open the front cover unit, and remove the cover [1].

- 1 screw [2]

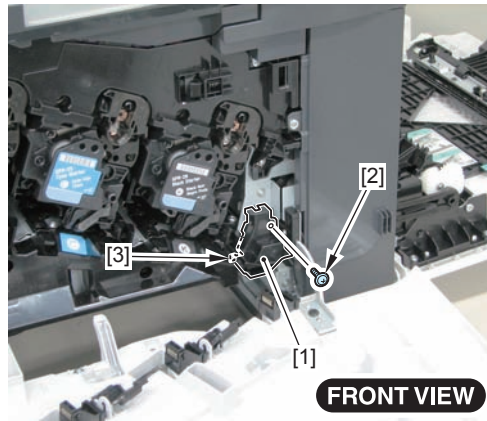

F-3-109

6) Remove the cover [1].

- 2 screws [2]
- 1 claw [3]

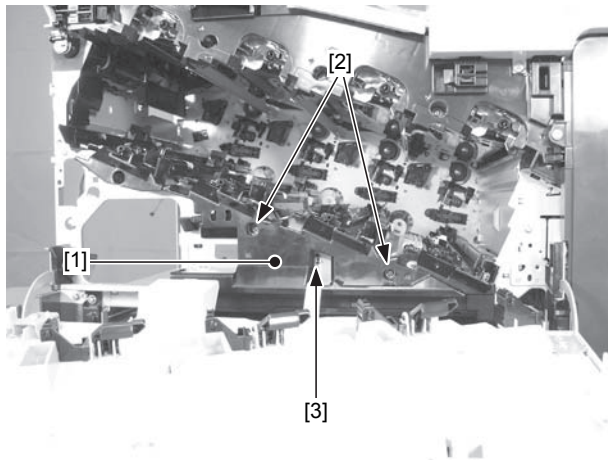

F-3-110

Caution :

When removing/installing the cover [1], be careful of the arm [2] because it easily comes off.

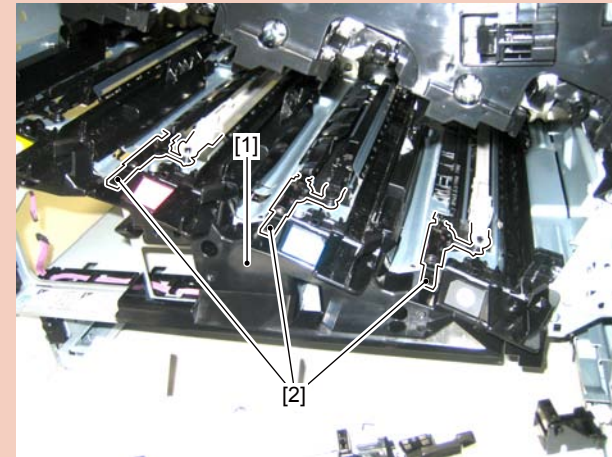

F-3-111

7) Remove the spring [1].

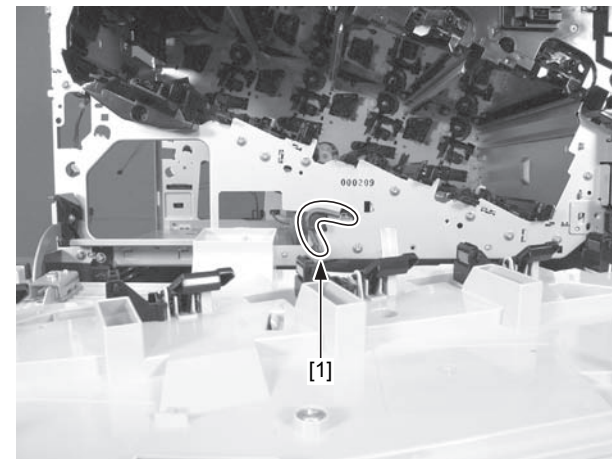

F-3-112

8) Remove the shaft [1] in the left side, remove the C/Bk scanner unit [2].

- 1 connector [3]

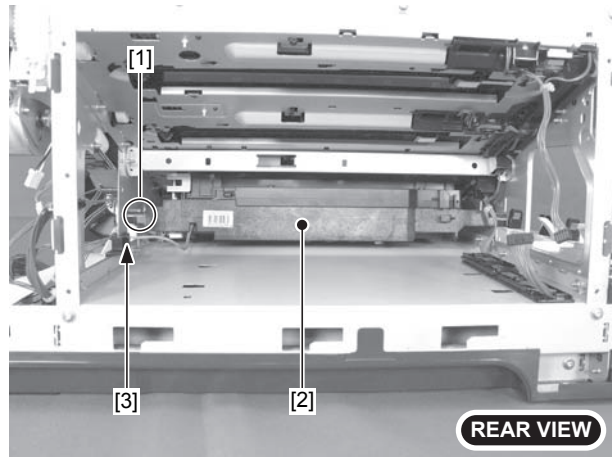

F-3-113

Points to note at installation :

- Make sure to adjust the position by inserting the protrusion [1] of Laser Scanner Unit into the frame hole [2].

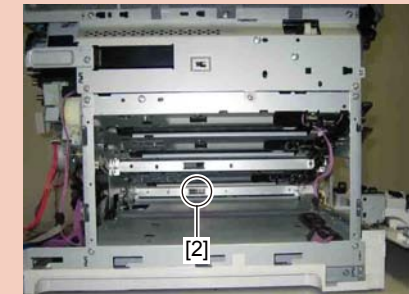
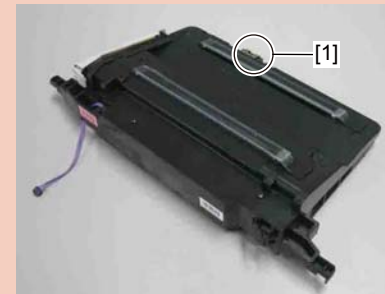

F-3-114

- When installing the cover, put the arm [1] through the cover hole [2].

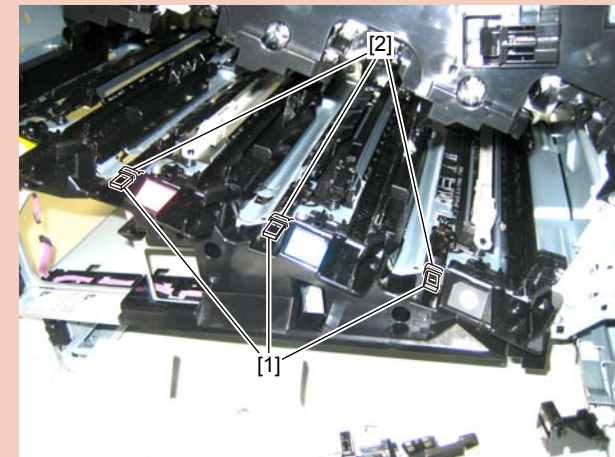

F-3-115

Removing Cassette Pickup Drive Unit

■ Before Removing Cassette Pickup Drive Unit(LBP7750C/ LBP5460)

- 1) Remove the left cover. (Refer to page 3-11)
- 2) Remove the rear cover. (Refer to page 3-12)
- 3) Remove the right rear cover. (Refer to page 3-13)
- 4) Remove the ICB PCB. (Refer to page 3-101)
- 5) Remove the main controller PCB. (Refer to page 3-101)
- 6) Remove the low-voltage power unit. (Refer to page 3-109)
- 7) Remove the lower high voltage power supply PCB. (Refer to page 3-115)
- 8) Remove the power fan. (Refer to page 3-79)

■ Before Removing Cassette Pickup Drive Unit(LBP7780C/ LBP5480)

- 1) Remove the left cover. (Refer to page 3-11)
- 2) Remove the right rear cover. (Refer to page 3-13)
- 3) Remove the rear cover. (Refer to page 3-12)
- 4) Remove the main controller PCB. (Refer to page 3-101)
- 5) Remove the low-voltage power unit. (Refer to page 3-109)
- 6) Remove the lower high voltage power supply PCB. (Refer to page 3-115)
- 7) Remove the power fan. (Refer to page 3-79)

■ Removing Cassette Pickup Drive Unit

- 1) Remove the harness [2] from the harness guide [1].
 - 6 connectors [3]

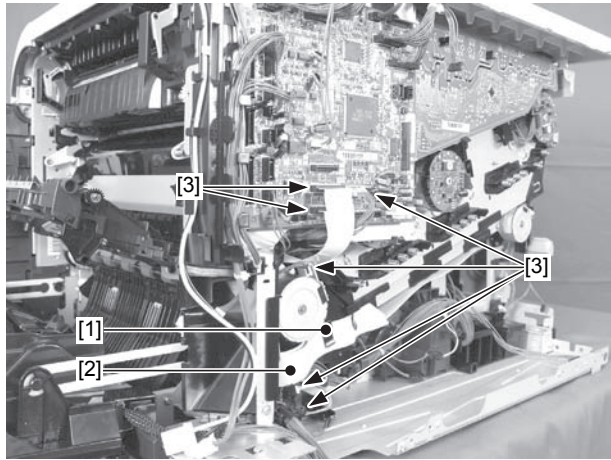

F-3-116

2) Remove the harness guide [1] by sliding it.

- 1 claw [2]

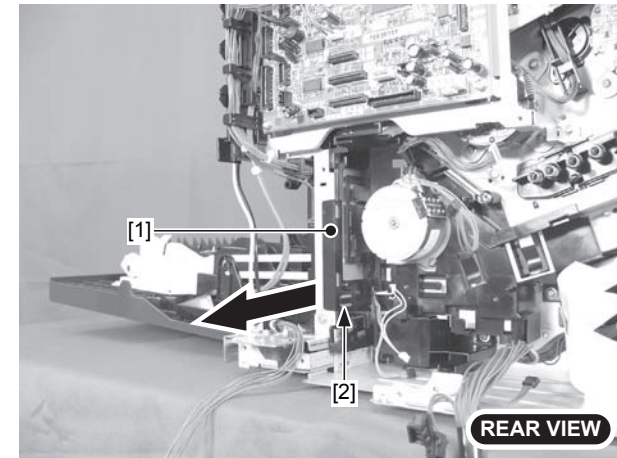

F-3-117

3) Remove the harness [1], and remove the harness guide [2] by sliding it in the direction of the arrow.

- 1 claw [3]

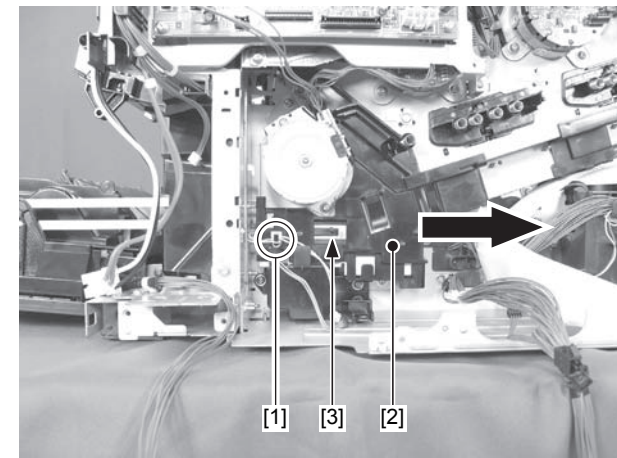

F-3-118

4) Remove the high-voltage PCB mount [1].

- 2 screws [2]

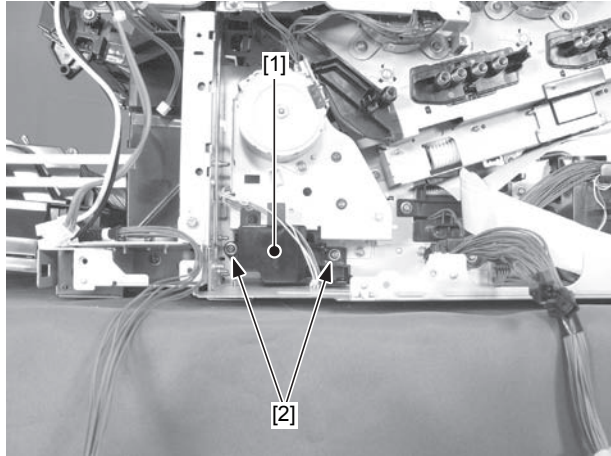

F-3-119

5) Remove the cassette pickup drive unit [1].

- 3 screws [2]

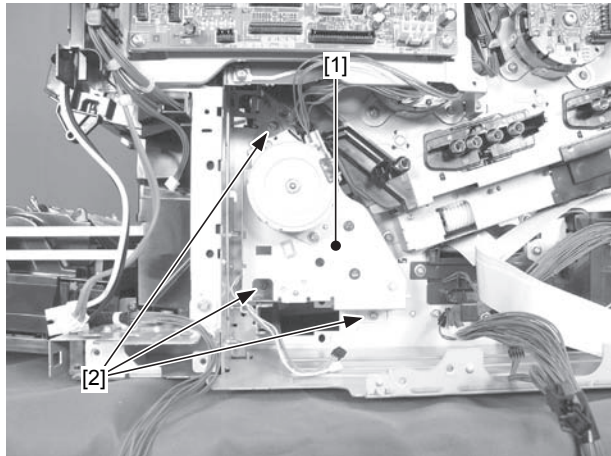

F-3-120

Removing Cassette Pickup Unit

Before Removing Cassette Pickup Unit

- 1) Remove the left cover. (Refer to page 3-11)
- 2) Remove the rear cover. (Refer to page 3-12)
- 3) Remove the right rear cover. (Refer to page 3-13)
- 4) Remove the secondary transfer unit. (Refer to page 3-27)
- 5) Remove the ICB PCB. (Refer to page 3-101)
- 6) Remove the main controller PCB. (Refer to page 3-101)
- 7) Remove the low-voltage power unit. (Refer to page 3-109)
- 8) Remove the lower high voltage power supply PCB. (Refer to page 3-115)
- 9) Remove the power fan. (Refer to page 3-79)
- 10) Remove the registration unit. (Refer to page 3-34)
- 11) Remove the cassette pickup drive unit. (Refer to page 3-50)

Removing Cassette Pickup Unit

- 1) Remove the gear [1].
- 1 claw [2].

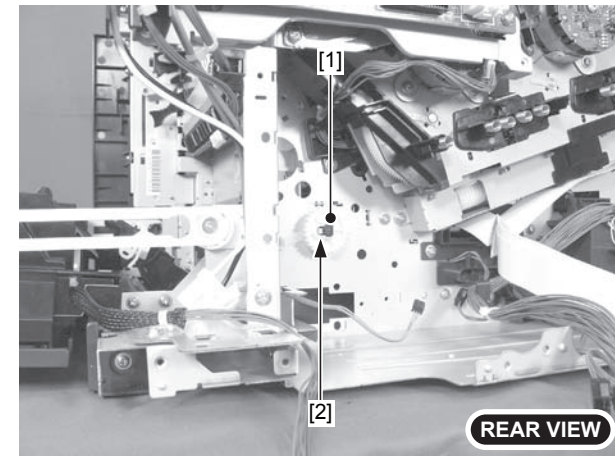

F-3-121

2) Remove the cassette pickup unit [1].

- 2 screws [2]

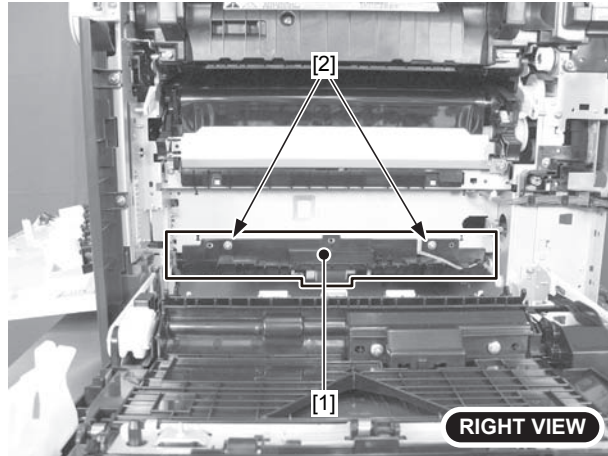

F-3-122

Removing Cassette Pickup Unit(LBP7780C/LBP5480)

Before Removing Cassette Pickup Unit

- 1) Remove the left cover.(Refer to page 3-11)
- 2) Remove the right rear cover.(Refer to page 3-13)
- 3) Remove the rear cover.(Refer to page 3-12)
- 4) Remove the secondary transfer unit.(Refer to page 3-27)
- 5) Remove the main controller PCB.(Refer to page 3-101)
- 6) Remove the low-voltage power unit.(Refer to page 3-109)
- 7) Remove the lower high voltage power supply PCB.(Refer to page 3-115)
- 8) Remove the power fan.(Refer to page 3-79)
- 9) Remove the registration unit.(Refer to page 3-34)
- 10) Remove the cassette pickup drive unit.(Refer to page 3-50)

Removing Cassette Pickup Unit

1) Remove the gear [1].

- 1 claw [2].

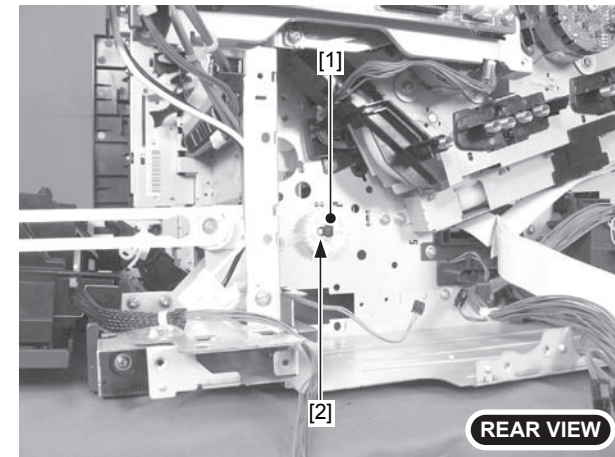

F-3-123

2) Remove the cassette pickup unit [1].

- 2 screws [2]

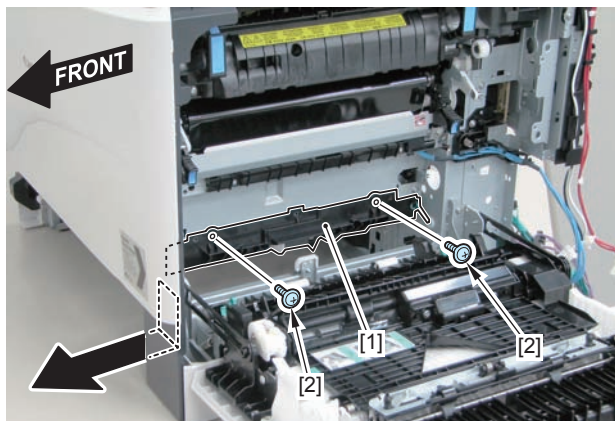

F-3-124

Removing the Main Drive Unit

Before Removing the Main Drive Unit

- 1) Remove the left cover. (Refer to page 3-11)
- 2) Remove the rear cover. (Refer to page 3-12)
- 3) Remove the ITB unit. (Refer to page 3-27)
- 4) Remove the right rear cover. (Refer to page 3-13)
- 5) Remove the ICB PCB. (Refer to page 3-101)
- 6) Remove the main controller PCB. (Refer to page 3-101)
- 7) Remove the low voltage power unit. (Refer to page 3-109)
- 8) Remove the lower high voltage power supply PCB. (Refer to page 3-115)
- 9) Remove the control panel unit right cover. (Refer to page 3-14)
- 10) Remove the control panel unit left cover. (Refer to page 3-15)
- 11) Remove the upper front cover unit. (Refer to page 3-16)
- 12) Remove the upper rear cover. (Refer to page 3-21)
- 13) Remove the DC controller PCB. (Refer to page 3-113)
- 14) Remove the upper high voltage power supply PCB. (Refer to page 3-119)
- 15) Remove the secondary transfer unit. (Refer to page 3-27)
- 16) Remove the power fan. (Refer to page 3-79)
- 17) Remove the toner cartridge.

Removing the Main Drive Unit

- 1) Remove the gear cover [1].
 - 2 screws [2]

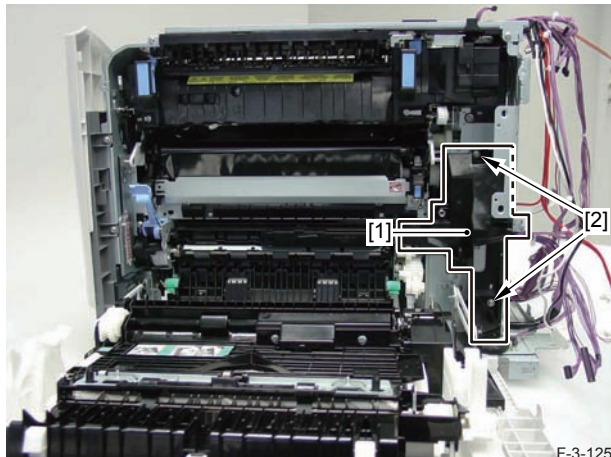

- 2) Remove the harness [1] and remove the high voltage contact point assembly [2].
 - 1 screw [3]

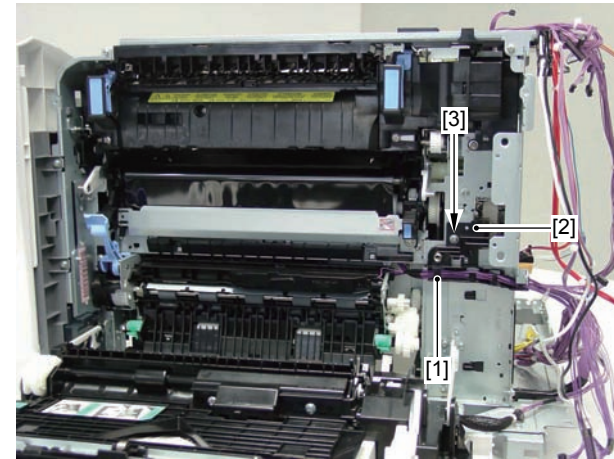

- 3) Remove the harness [2] from the harness guide [1].
 - 7 connectors [3]

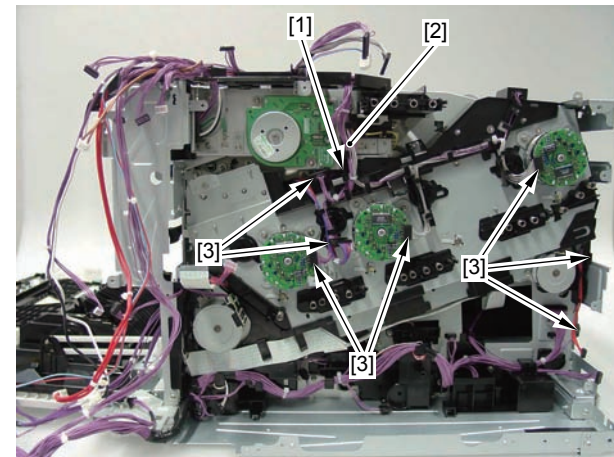

- 4) Remove the flat cable [1] from the harness guide [2].
- 5) Remove the harness guide [3].
- 1 claw [4]

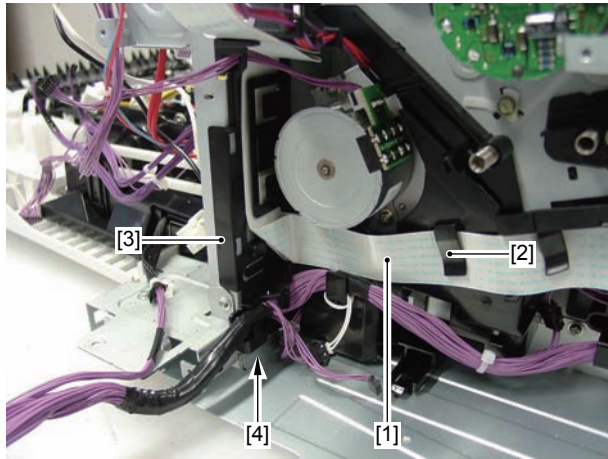

F-3-128

- 6) Remove the 2 plates [1].
- 2 screws [2]

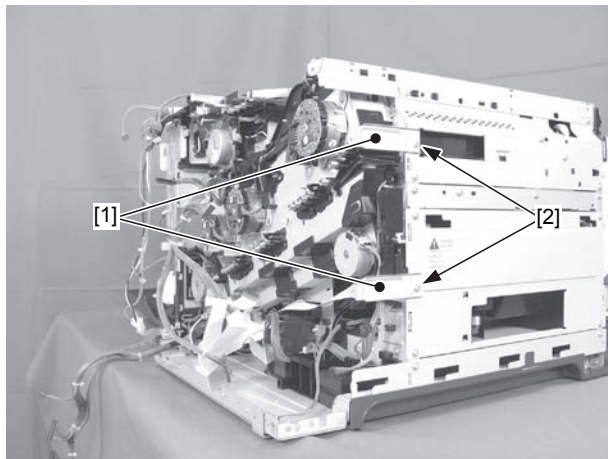

F-3-129

- 7) Remove the developing disengagement motor [1].
- 2 screws [2]
- 8) Remove the stay [3].
- 1 screw [4].
- 9) Remove the harness guide [5] in 2 places .
- 1 claw each
- 10) Remove the main drive unit [6].
- 10 screws [7]

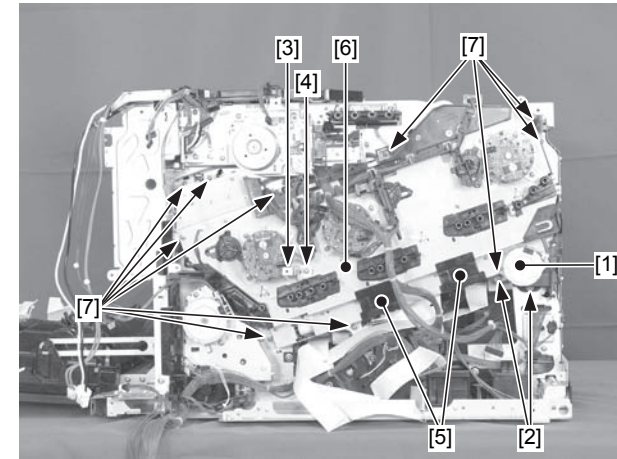

F-3-130

Caution :

Be sure not to hit the cam [1] of the main drive to the plate [2].

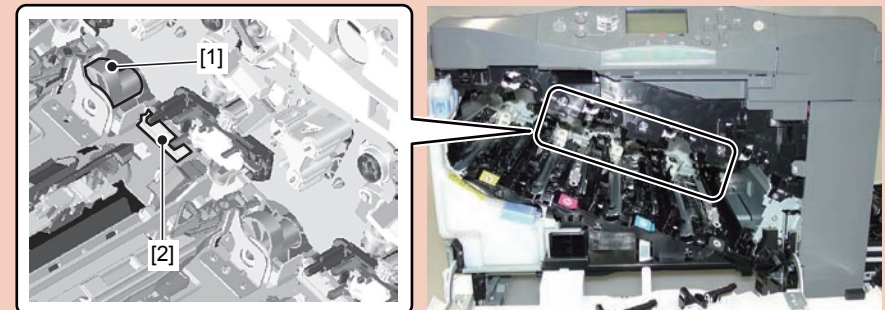

F-3-131

How to Check the Phase of Main Drive Unit Cam

1) Check the positions of 4 cams [1].

Phase of 4 cams are adjusted by aligning the 4 holes of the gear [2] with the hole of the frame. As shown in the enlarged view [3], turn the shaft [4] until 4 holes of the gear [2] is in the indicated position. At the same time, the hole of the frame [5] overlaps with the hole of the gear [2].

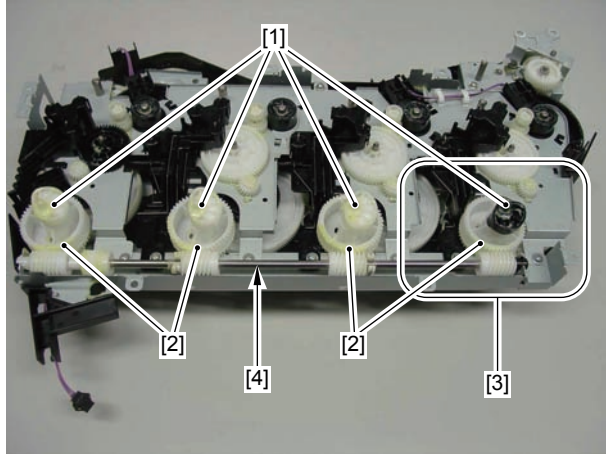

F-3-132

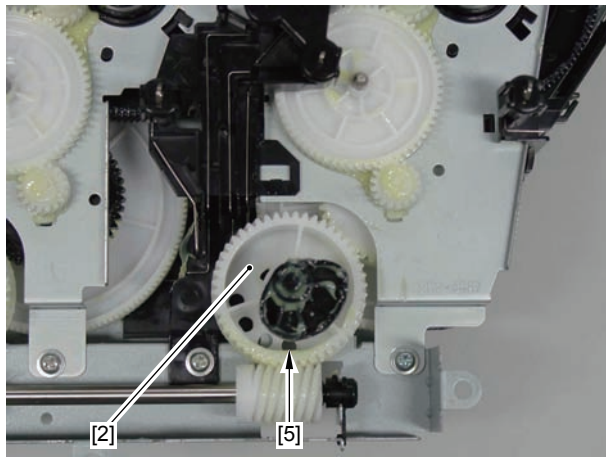

F-3-133

Points to note when installing the main drive unit :

- Check the phase position of the main drive unit cam.
- Make sure that the shaft of the gear [1] on the main drive unit is surely fitted to the frame [2] of the host machine.

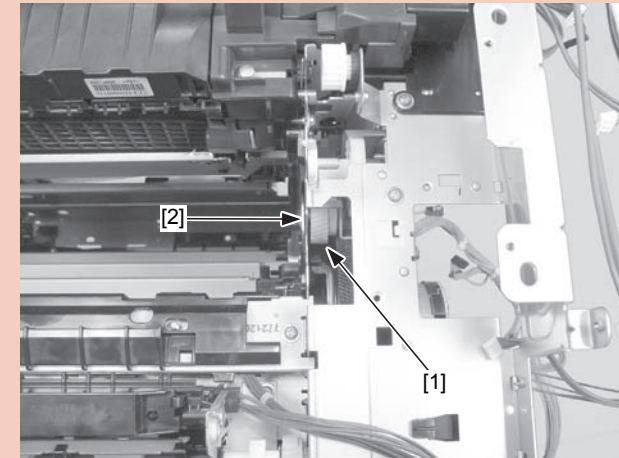

F-3-134

- Make sure that the joint part of the screw on the main drive unit is securely fitted to the host machine frame, and then tighten the screw.

Removing the Main Drive Unit(LBP7780C/LBP5480)

Before Removing the Main Drive Unit

- 1) Remove the left cover.(Refer to page 3-11)
- 2) Remove the right rear cover.(Refer to page 3-13)
- 3) Remove the rear cover.(Refer to page 3-12)
- 4) Remove the ITB unit.(Refer to page 3-27)
- 5) Remove the main controller PCB.(Refer to page 3-101)
- 6) Remove the low voltage power unit.(Refer to page 3-109)
- 7) Remove the lower high voltage power supply PCB.(Refer to page 3-115)
- 8) Remove the control panel unit right cover.(Refer to page 3-14)
- 9) Remove the control panel unit left cover.(Refer to page 3-15)
- 10) Remove the upper front cover unit.(Refer to page 3-16)
- 11) Remove the upper rear cover.(Refer to page 3-21)
- 12) Remove the DC controller PCB.(Refer to page 3-113)
- 13) Remove the upper high voltage power supply PCB.(Refer to page 3-119)
- 14) Remove the secondary transfer unit.(Refer to page 3-27)
- 15) Remove the power fan.(Refer to page 3-79)
- 16) Remove the toner cartridge.

Removing the Main Drive Unit

- 1) Remove the gear cover [1].
 - 2 screws [2]

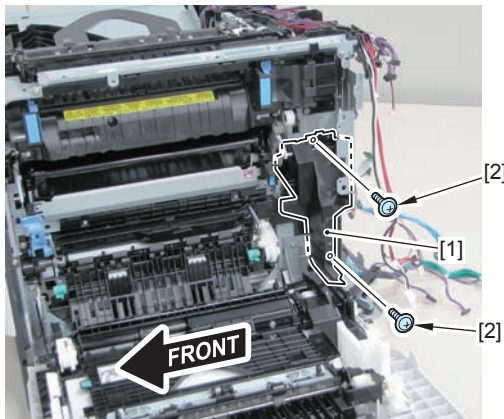

F-3-135

- 2) Remove the harness [1] and remove the high voltage contact point assembly [2].
 - 1 screw [3]

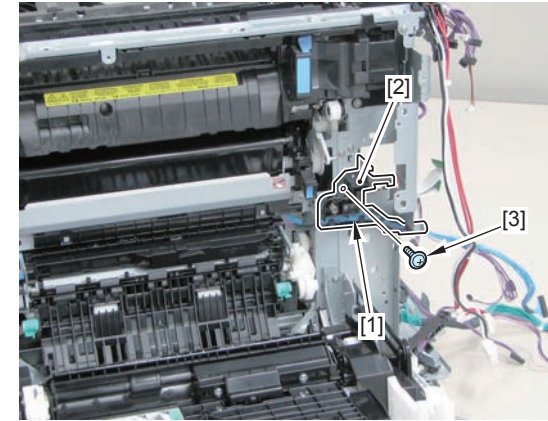

F-3-136

- 3) Remove the harness [2] from the harness guide [1].
 - 7 connectors [3]

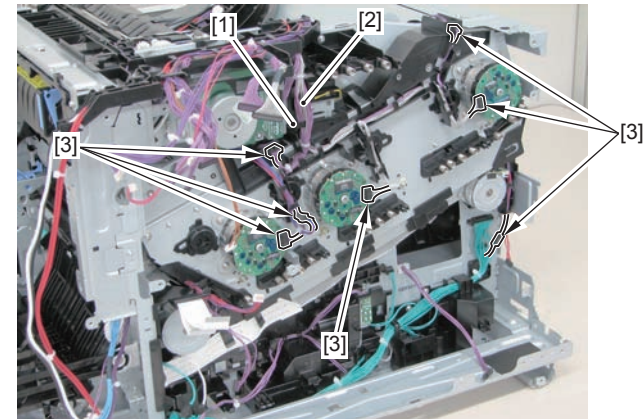

F-3-137

- 4) Remove the flat cable [1] from the harness guide[2].
- 5) Remove the harness guide [3].
 - 1 claw [4]

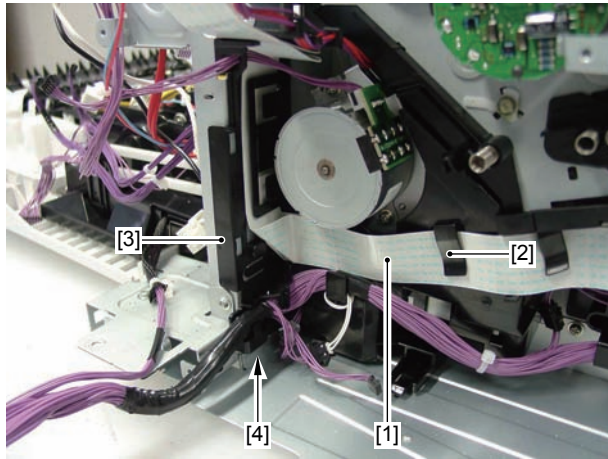

F-3-138

- 6) Remove the 2 plates [1].
 - 2 screws [2]

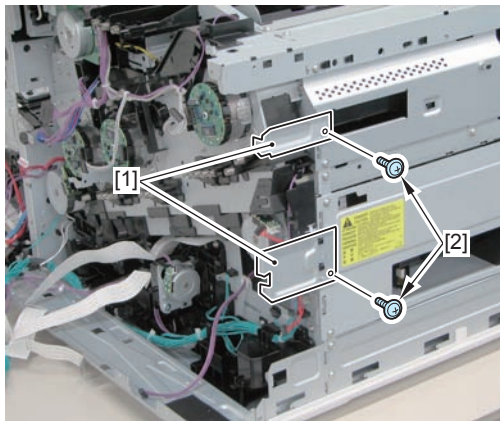

F-3-139

- 7) Remove the developing disengagement motor [1].
 - 2 screws [2]
- 8) Remove the stay [3].
 - 1 screw [4].
- 9) Remove the harness guide [5] in 2 places .
 - 1 claw each
- 10) Remove the main drive unit [6].
 - 10 screws [7]

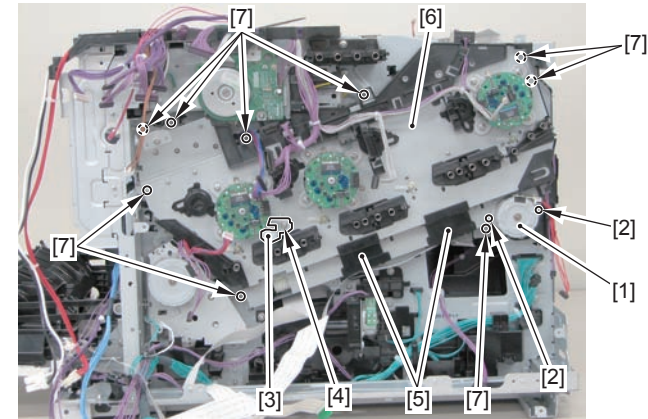

F-3-140

Caution :

Be sure not to hit the cam [1] of the main drive to the plate [2].

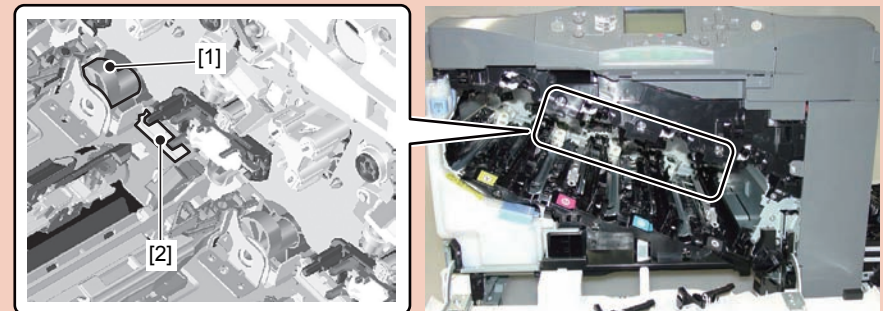

F-3-141

How to Check the Phase of Main Drive Unit Cam

1) Check the positions of 4 cams [1].

Phase of 4 cams are adjusted by aligning the 4 holes of the gear [2] with the hole of the frame. As shown in the enlarged view [3], turn the shaft [4] until 4 holes of the gear [2] is in the indicated position. At the same time, the hole of the frame [5] overlaps with the hole of the gear [2].

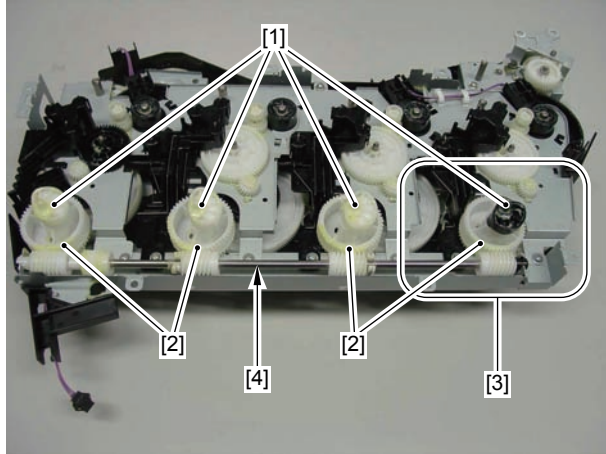

F-3-142

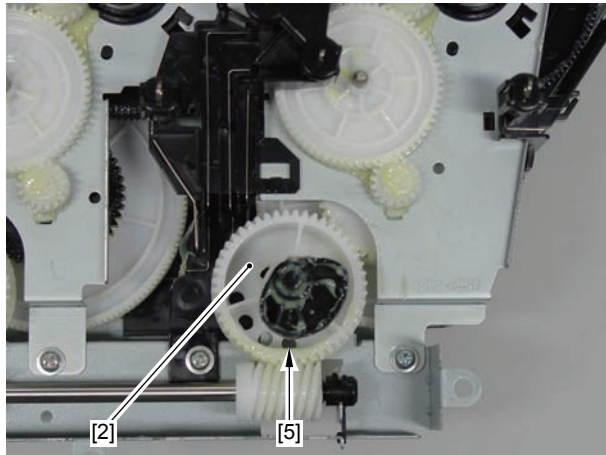

F-3-143

Points to note when installing the main drive unit :

- Check the phase position of the main drive unit cam.
- Make sure that the shaft of the gear [1] on the main drive unit is surely fitted to the frame [2] of the host machine.

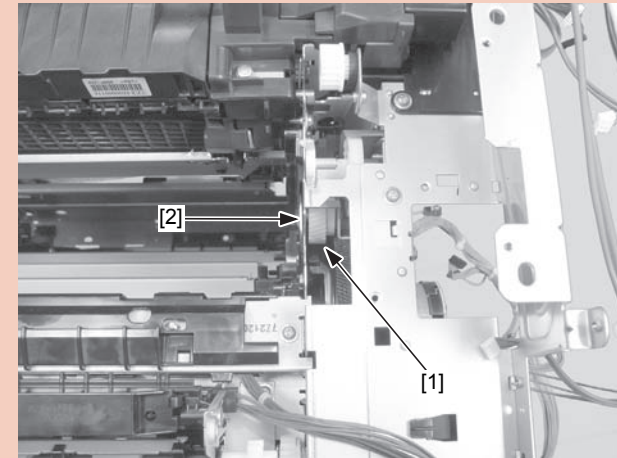

F-3-144

- Make sure that the joint part of the screw on the main drive unit is securely fitted to the host machine frame, and then tighten the screw.

Removing the Fixing Drive Unit

Before Removing the Fixing Drive Unit

- 1) Remove the left cover. (Refer to page 3-11)
- 2) Remove the rear cover. (Refer to page 3-12)
- 3) Remove the ITB unit. (Refer to page 3-27)
- 4) Remove the fixing assembly. (Refer to page 3-28)
- 5) Remove the right rear cover. (Refer to page 3-13)
- 6) Remove the ICB PCB. (Refer to page 3-101)
- 7) Remove the main controller PCB. (Refer to page 3-101)
- 8) Remove the low voltage power unit. (Refer to page 3-109)
- 9) Remove the lower high voltage power supply PCB. (Refer to page 3-115)
- 10) Remove the control panel unit right cover. (Refer to page 3-14)
- 11) Remove the control panel unit left cover. (Refer to page 3-15)
- 12) Remove the upper front cover unit. (Refer to page 3-16)
- 13) Remove the upper rear cover. (Refer to page 3-21)
- 14) Remove the upper high voltage power supply PCB. (Refer to page 3-119)
- 15) Remove the toner cartridge.
- 16) Remove the main drive unit. (Refer to page 3-55)

Caution :

When installing the main drive unit, refer to the points to note when installing the main drive unit.

Removing the Fixing Drive Unit

1) Remove the harness [1].

- 1 connector [2]
- 2) Remove the harness guide [3].
- 2 screws [4]

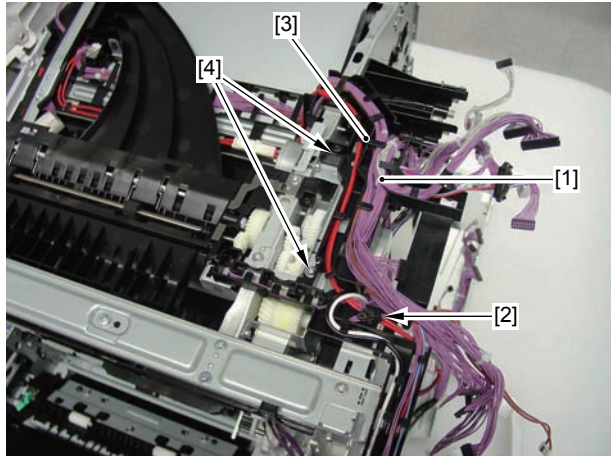

F-3-145

3) Remove the plate [1].

- 1 screw [2]

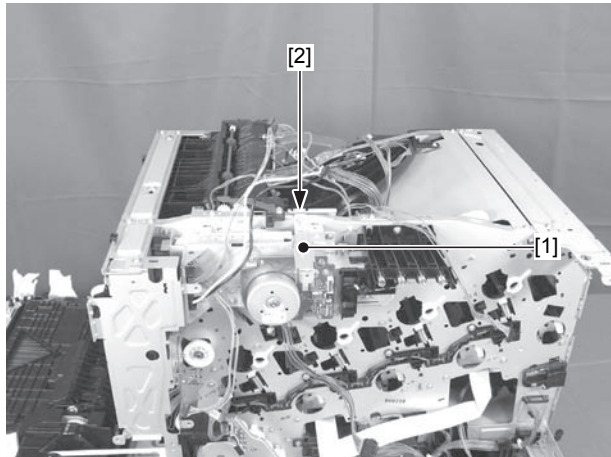

F-3-146

4) Remove the cover [1].

- 1 screw [2]

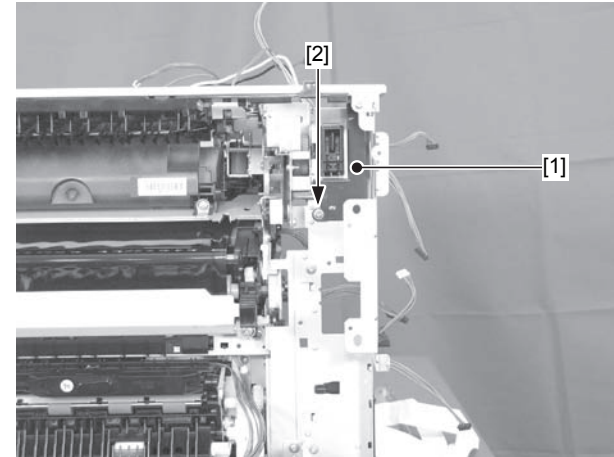

F-3-147

5) Remove the fixing drive unit [1].

- 5 screws [2]

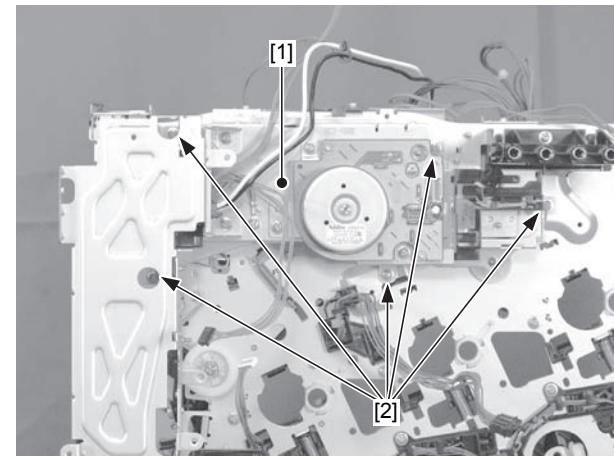

F-3-148

Removing the Fixing Drive Unit(LBP7780C/LBP5480)

Before Removing the Fixing Drive Unit

- 1) Remove the left cover.(Refer to page 3-11)
- 2) Remove the right rear cover.(Refer to page 3-13)
- 3) Remove the rear cover.(Refer to page 3-12)
- 4) Remove the ITB unit.(Refer to page 3-27)
- 5) Remove the fixing assembly.(Refer to page 3-28)
- 6) Remove the main controller PCB.(Refer to page 3-101)
- 7) Remove the low voltage power unit.(Refer to page 3-109)
- 8) Remove the lower high voltage power supply PCB.(Refer to page 3-115)
- 9) Remove the control panel unit right cover.(Refer to page 3-14)
- 10) Remove the control panel unit left cover.(Refer to page 3-15)
- 11) Remove the upper front cover unit.(Refer to page 3-16)
- 12) Remove the upper rear cover.(Refer to page 3-21)
- 13) Remove the upper high voltage power supply PCB.(Refer to page 3-119)
- 14) Remove the toner cartridge.
- 15) Remove the main drive unit.(Refer to page 3-55)

Caution :

When installing the main drive unit, refer to the points to note when installing the main drive unit.

Removing the Fixing Drive Unit

- 1) Remove the harness [1].
 - 1 connector [2]
- 2) Remove the harness guide [3].
 - 2 screws [4]

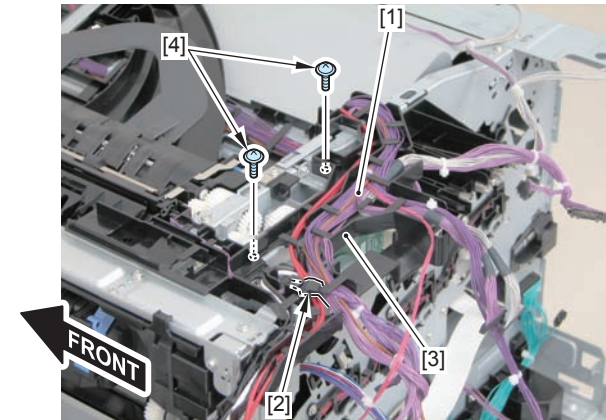

F-3-149

- 3) Remove the plate [1].
 - 1 screw [2]

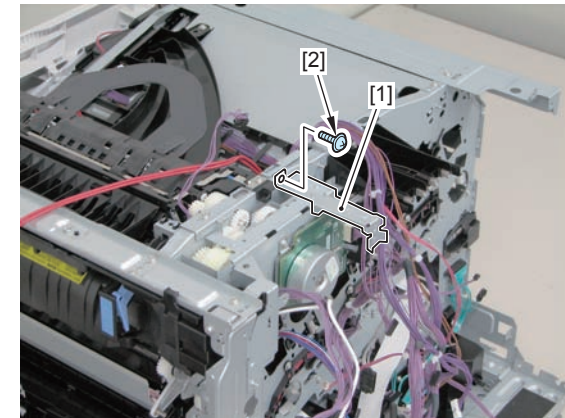

F-3-150

4) Remove the cover [1].

- 1 screw [2]

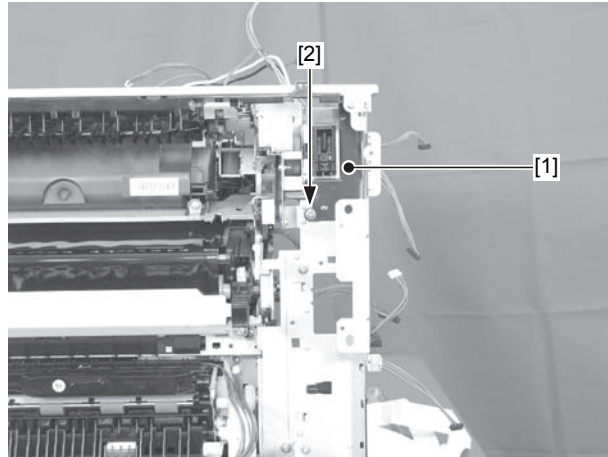

F-3-151

5) Remove the fixing drive unit [1].

- 5 screws [2]
- 2 connectors [3]

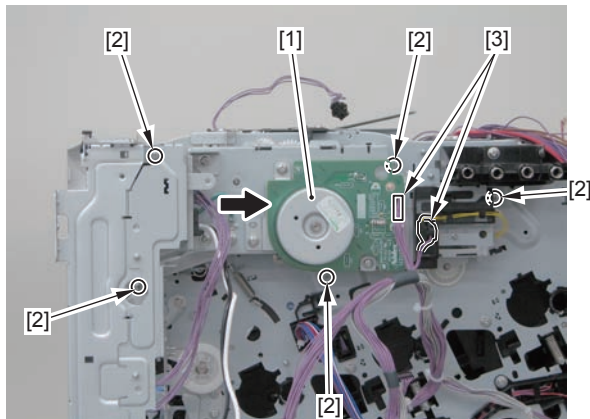

F-3-152

Removing the Delivery Unit

Before Removing the Delivery Unit

- 1) Remove the left cover. (Refer to page 3-11)
- 2) Remove the rear cover. (Refer to page 3-12)
- 3) Remove the ITB unit. (Refer to page 3-27)
- 4) Remove the fixing assembly. (Refer to page 3-28)
- 5) Remove the right rear cover. (Refer to page 3-13)
- 6) Remove the ICB PCB. (Refer to page 3-101)
- 7) Remove the main controller PCB. (Refer to page 3-101)
- 8) Remove the low voltage power unit. (Refer to page 3-109)
- 9) Remove the lower high voltage power supply PCB. (Refer to page 3-115)
- 10) Remove the control panel unit right cover. (Refer to page 3-14)
- 11) Remove the control panel unit left cover. (Refer to page 3-15)
- 12) Remove the upper front cover unit. (Refer to page 3-16)
- 13) Remove the upper rear cover. (Refer to page 3-21)
- 14) Remove the upper high voltage power supply PCB. (Refer to page 3-119)
- 15) Remove the toner cartridge.
- 16) Remove the main drive unit. (Refer to page 3-55)
- 17) Remove the fixing drive unit. (Refer to page 3-61)

Removing the Delivery Unit

1) Remove the guide [1].

- 2 screws [2]

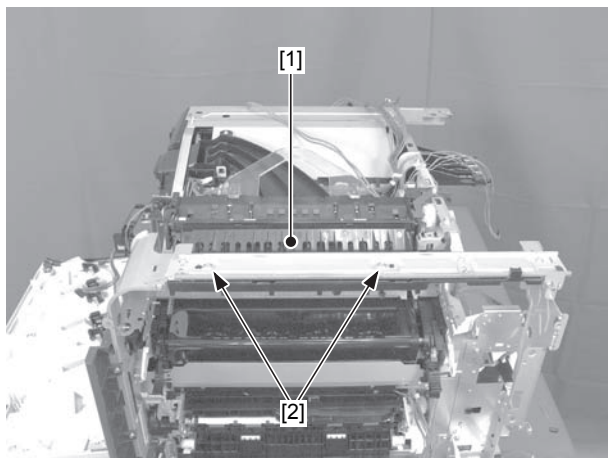

F-3-153

2) Remove the 2 screws [1].

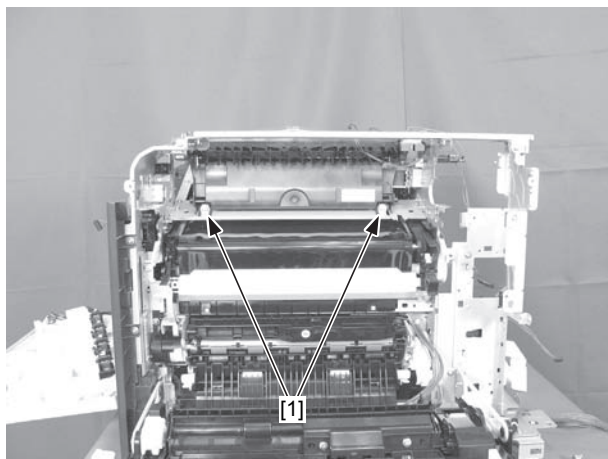

F-3-154

3) Remove the gear [1].

- 1 claw [2]



F-3-155

4) Turn and remove the shaft support [1].

- 1 claw [2]

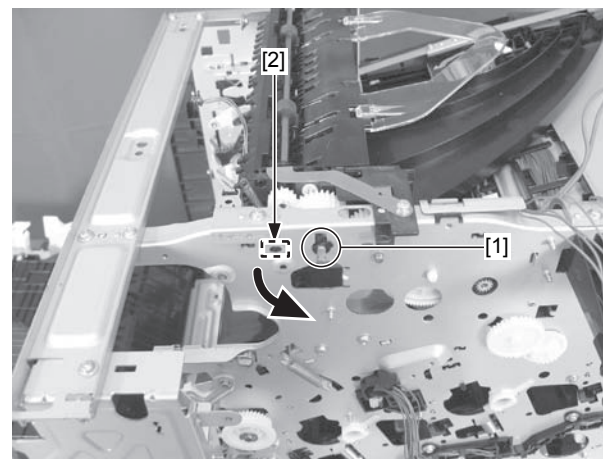

F-3-156

5) Remove the delivery unit [1].

- 1 connector [2]
- 2 screws [3]

Caution:

Do not transform or lost the spring [4].

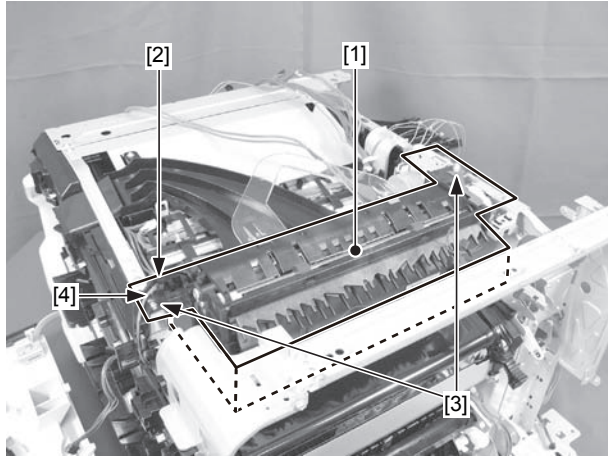

F-3-157

MEMO :

When installing the unit, fit the core [1] in the solenoid surely.

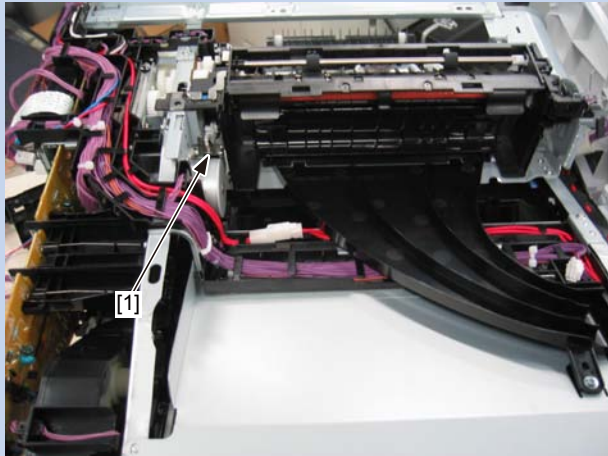

F-3-158

Removing the Delivery Unit(LBP7780C/LBP5480)

Before Removing the Delivery Unit

- 1) Remove the left cover.(Refer to page 3-11)
- 2) Remove the right rear cover.(Refer to page 3-13)
- 3) Remove the rear cover.(Refer to page 3-12)
- 4) Remove the ITB unit.(Refer to page 3-27)
- 5) Remove the fixing assembly.(Refer to page 3-28)
- 6) Remove the main controller PCB.(Refer to page 3-101)
- 7) Remove the low voltage power unit.(Refer to page 3-109)
- 8) Remove the lower high voltage power supply PCB.(Refer to page 3-115)
- 9) Remove the control panel unit right cover.(Refer to page 3-14)
- 10) Remove the control panel unit left cover.(Refer to page 3-15)
- 11) Remove the upper front cover unit.(Refer to page 3-16)
- 12) Remove the upper rear cover.(Refer to page 3-21)
- 13) Remove the upper high voltage power supply PCB.(Refer to page 3-119)
- 14) Remove the toner cartridge.
- 15) Remove the main drive unit.(Refer to page 3-55)
- 16) Remove the fixing drive unit.(Refer to page 3-61)

Removing the Delivery Unit

- 1) Remove the guide [1].
- 2 screws [2]

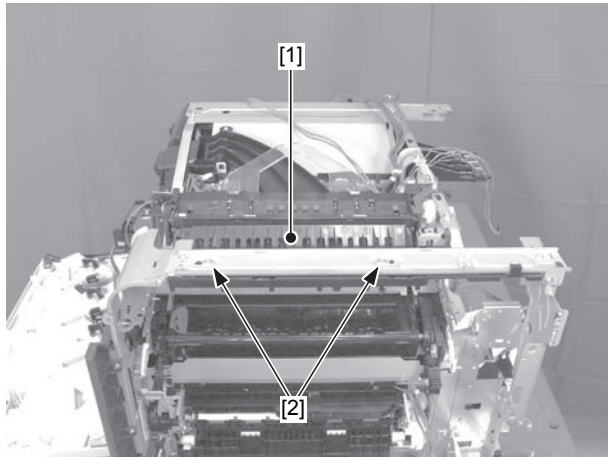

F-3-159

- 2) Remove the 2 screws [1].

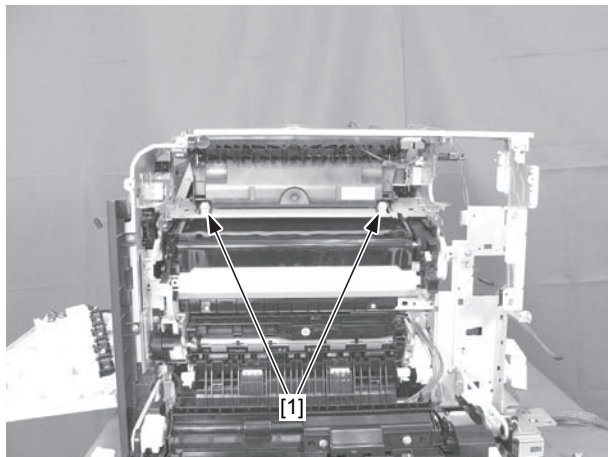

F-3-160

- 3) Remove the gear [1].
- 1 claw [2]

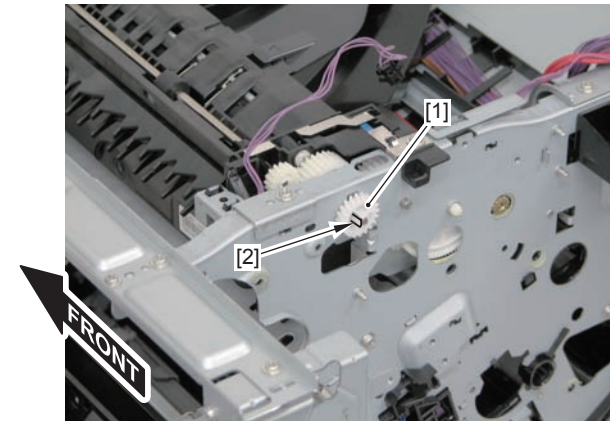

F-3-161

- 4) Turn and remove the shaft support [1].
- 1 claw [2]

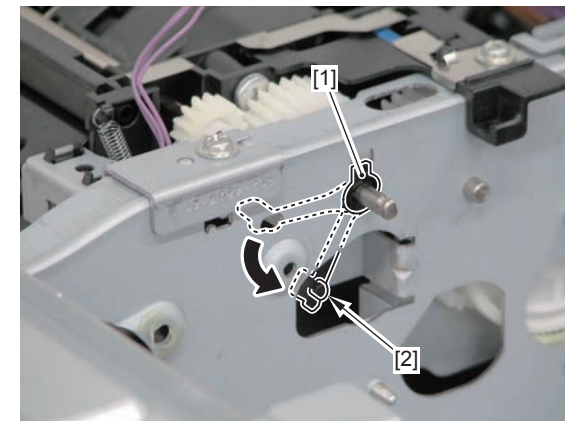

F-3-162

5) Remove the delivery unit [1].

- 1 connector [2]
- 2 screws [3]

Caution:

Do not transform or lost the spring [4].

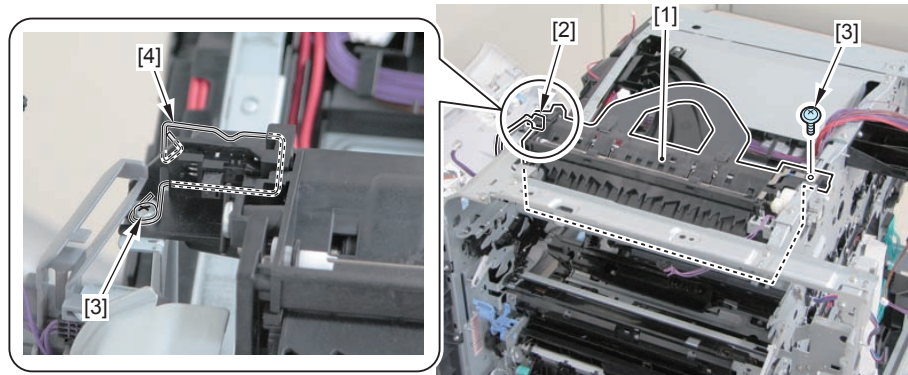

F-3-163

MEMO :

When installing the unit, fit the core [1] in the solenoid surely.

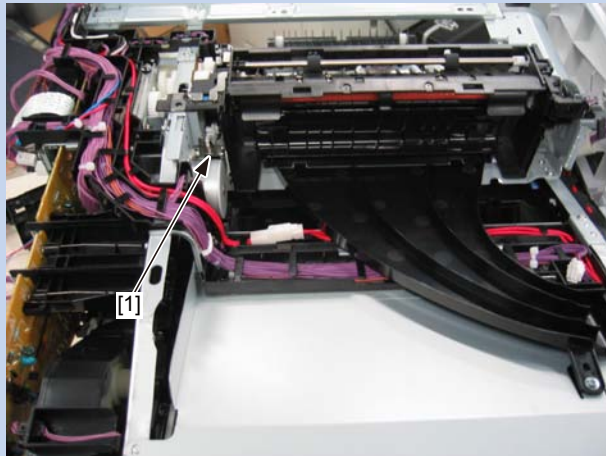

F-3-164

Removing the Duplex Drive Unit

Before Removing the Duplex Drive Unit

- 1) Remove the left cover. (Refer to page 3-11)
- 2) Remove the rear cover. (Refer to page 3-12)
- 3) Remove the ITB unit. (Refer to page 3-27)
- 4) Remove the fixing assembly. (Refer to page 3-28)
- 5) Remove the right rear cover. (Refer to page 3-13)
- 6) Remove the ICB PCB. (Refer to page 3-101)
- 7) Remove the main controller PCB. (Refer to page 3-101)
- 8) Remove the low voltage power unit. (Refer to page 3-109)
- 9) Remove the lower high voltage power supply PCB. (Refer to page 3-115)
- 10) Remove the control panel unit right cover. (Refer to page 3-14)
- 11) Remove the control panel unit left cover. (Refer to page 3-15)
- 12) Remove the upper front cover unit. (Refer to page 3-16)
- 13) Remove the upper rear cover. (Refer to page 3-21)
- 14) Remove the upper high voltage power supply PCB. (Refer to page 3-119)
- 15) Remove the toner cartridge.
- 16) Remove the main drive unit. (Refer to page 3-55)
- 17) Remove the fixing drive unit. (Refer to page 3-61)
- 18) Remove the delivery unit. (Refer to page 3-64)

■ Removing the Duplex Drive Unit

1) Remove the duplex drive unit [1].

- 2 connectors [2]
- 3 screws [3]

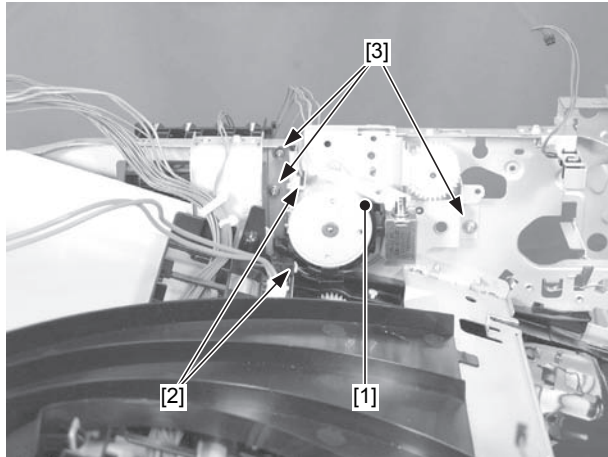

F-3-165

● Removing the Duplex Drive Unit(LBP7780C/LBP5480)

■ Before Removing the Duplex Drive Unit

- 1) Remove the left cover.(Refer to page 3-11)
- 2) Remove the right rear cover.(Refer to page 3-13)
- 3) Remove the rear cover.(Refer to page 3-12)
- 4) Remove the ITB unit.(Refer to page 3-27)
- 5) Remove the fixing assembly.(Refer to page 3-28)
- 6) Remove the main controller PCB.(Refer to page 3-101)
- 7) Remove the low voltage power unit.(Refer to page 3-109)
- 8) Remove the lower high voltage power supply PCB.(Refer to page 3-115)
- 9) Remove the control panel unit right cover.(Refer to page 3-14)
- 10) Remove the control panel unit left cover.(Refer to page 3-15)
- 11) Remove the upper front cover unit.(Refer to page 3-16)
- 12) Remove the upper rear cover.(Refer to page 3-21)
- 13) Remove the upper high voltage power supply PCB.(Refer to page 3-119)
- 14) Remove the toner cartridge.
- 15) Remove the main drive unit.(Refer to page 3-55)
- 16) Remove the fixing drive unit.(Refer to page 3-63)
- 17) Remove the delivery unit.(Refer to page 3-66)

Removing the Duplex Drive Unit

- 1) Remove the duplex drive unit [1].
 - 2 connectors [2]
 - 3 screws [3]

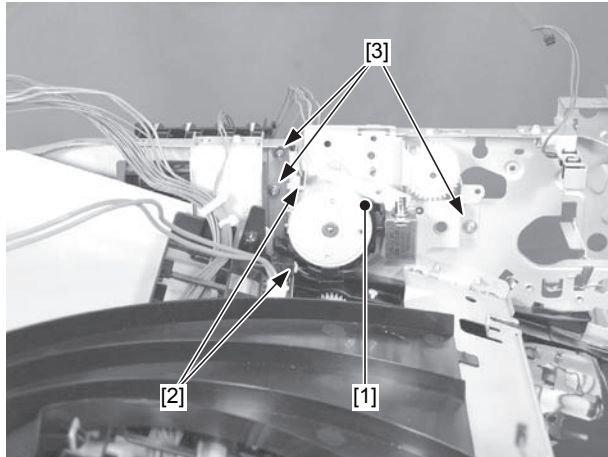

F-3-166

Removing the Duplex Feed Roller Unit

- 1) Open the right cover unit.
- 2) Remove the duplex feed guide [1].
 - 3 screws [2]

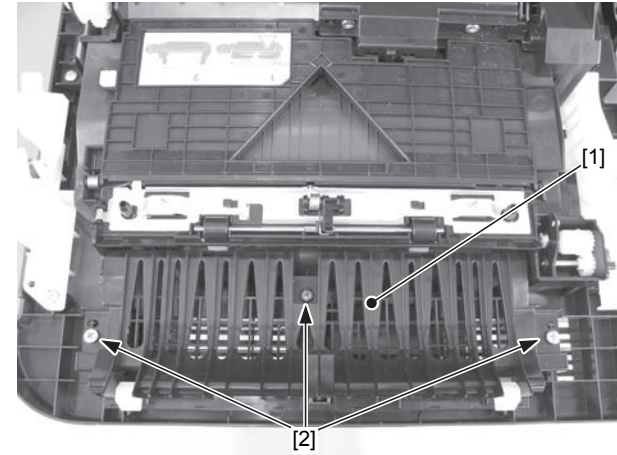

F-3-167

- 3) Slide the duplex feed roller unit [1] in the direction of the arrow and remove it.

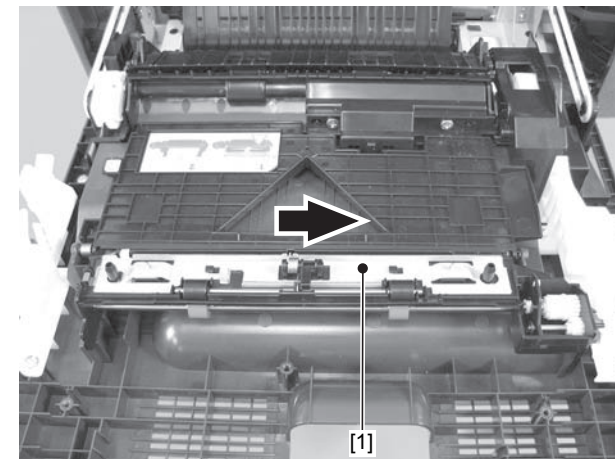

F-3-168

Removing the Duplex Feed Roller Unit(LBP7780C/ LBP5480)

- 1) Open the right cover unit.
- 2) Remove the duplex feed guide [1].
 - 2 screws [2]

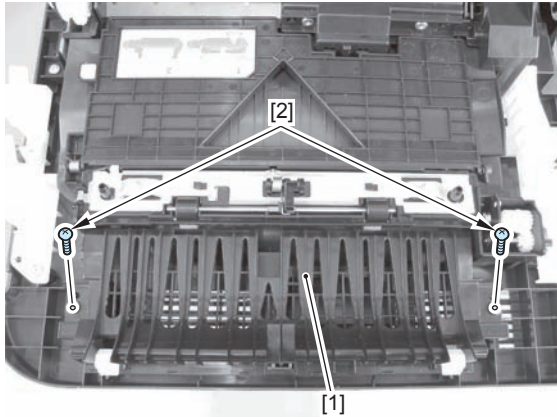

F-3-169

- 3) Slide the duplex feed roller unit [1] in the direction of the arrow and remove it.

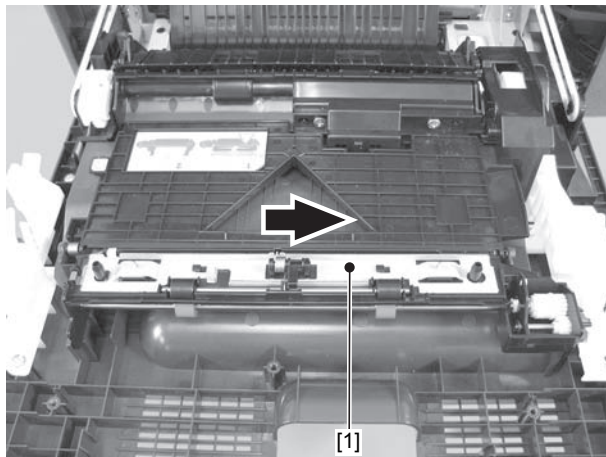

F-3-170

Removing the Multi-purpose Tray Pickup Unit

Before Removing the Multi-purpose Tray Pickup Unit

- 1) Remove the right cover unit. (Refer to page 3-25)

Removing the Multi-purpose Tray Pickup Unit

- 1) Remove the cover [1].
 - 2 claws [2]

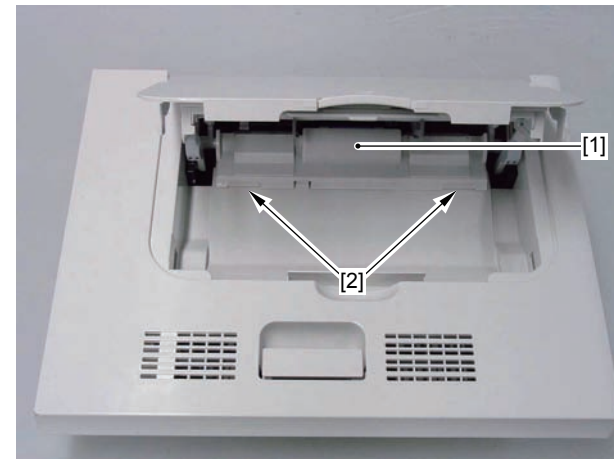

F-3-171

- 2) Remove the shaft [1] from the shaft support [2].

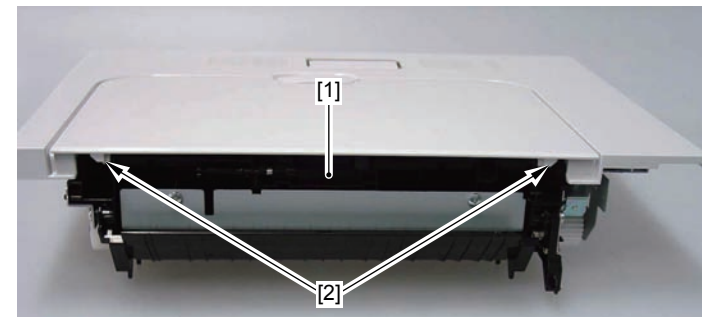

F-3-172

3) Remove the 2 springs [1].

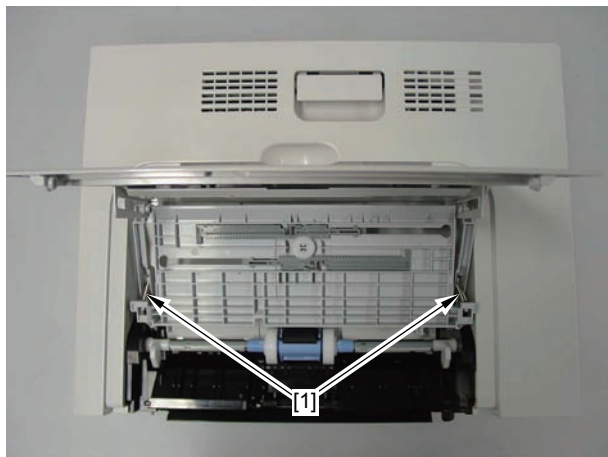

F-3-173

4) Remove the 2 arms [1] from the 2 shaft supports [2] in the indicated angle and remove the manual tray cover unit [3].

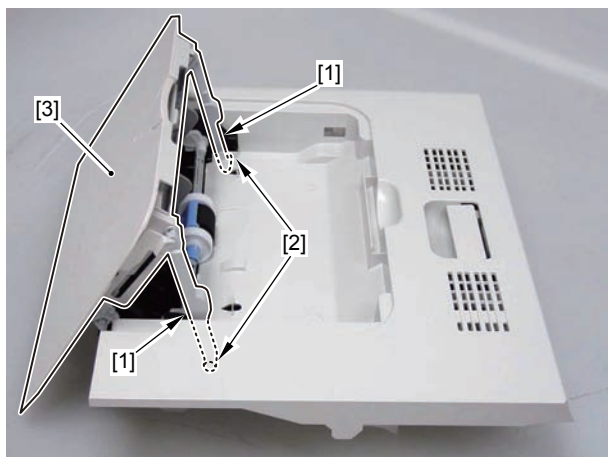

F-3-174

5) Remove the shaft [1] from the shaft support [2] in 2 places and remove the feed unit cover [3].

Caution:

Do not lost the spring [4].

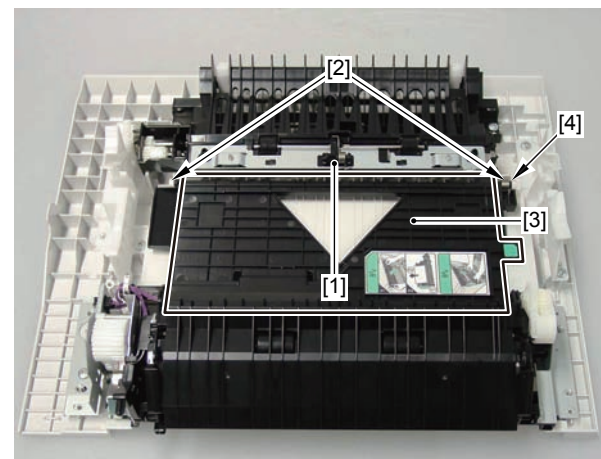

F-3-175

6) Remove the plate [1] and remove the 2 connectors [2].

- 1 screw [3]
- 1 spring [4]

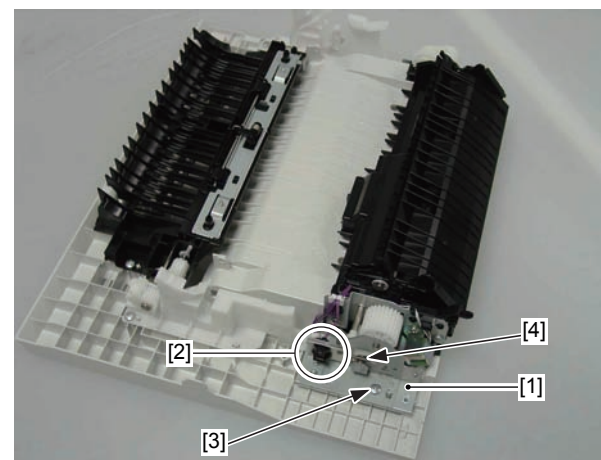

F-3-176

7) Remove the spring [1] and the gear [2].

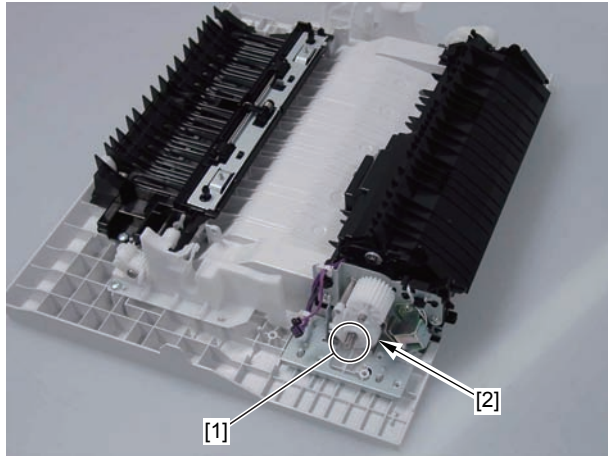

F-3-177

MEMO :

When installing the spring, install the gear first and then, install the spring to the center of the gear.

8) Remove the plate [1].

- 1 screw [2]

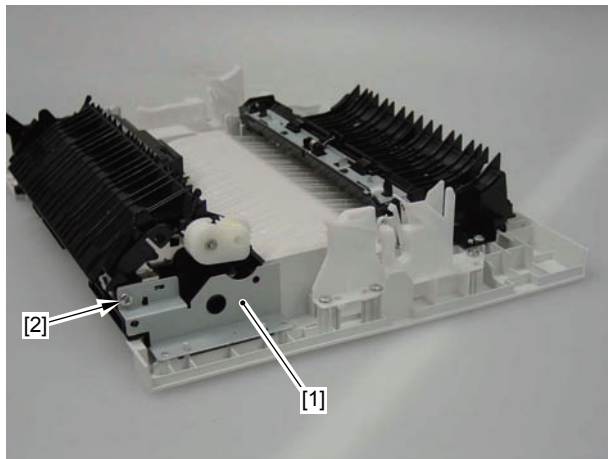

F-3-178

9) Disengage the plate [1] from the boss and slide the multi-purpose tray pickup unit [2] in the direction of the arrow.

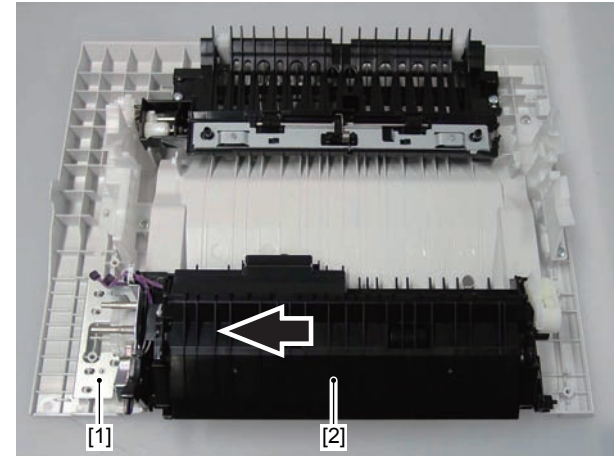

F-3-179

Removing the Multi-purpose Tray Pickup Unit (LBP7780C/LBP5480)

Before Removing the Multi-purpose Tray Pickup Unit

1) Remove the right cover unit. (Refer to page 3-25)

Removing the Multi-purpose Tray Pickup Unit

1) Remove the cover [1].

- 2 claws [2]

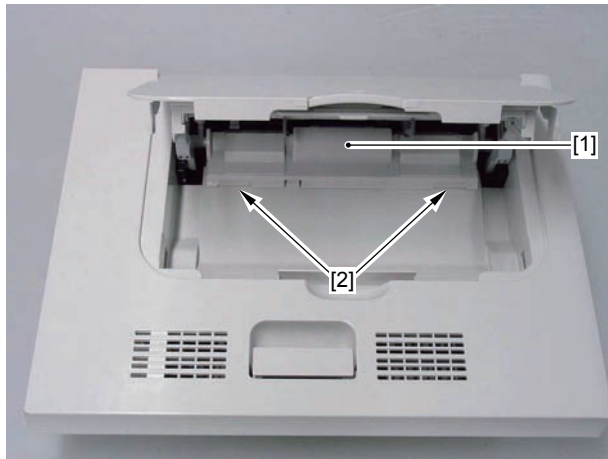

F-3-180

2) Remove the shaft [1] from the shaft support [2].

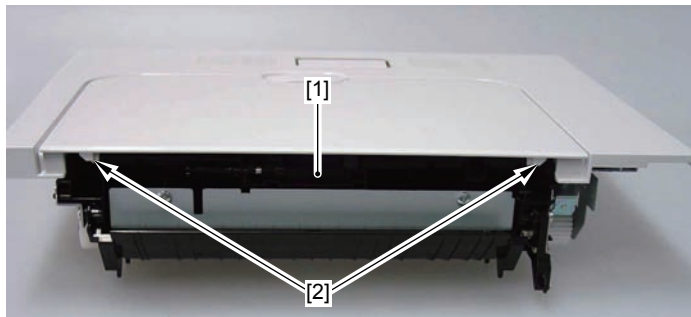

F-3-181

3) Remove the 2 springs [1].

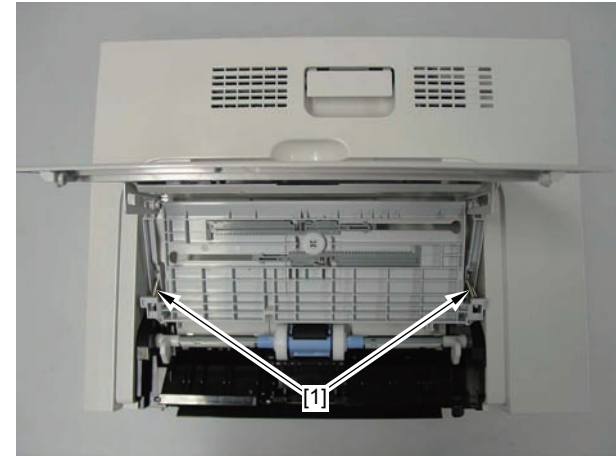

F-3-182

4) Remove the 2 arms [1] from the 2 shaft supports [2] in the indicated angle and remove the manual tray cover unit [3].

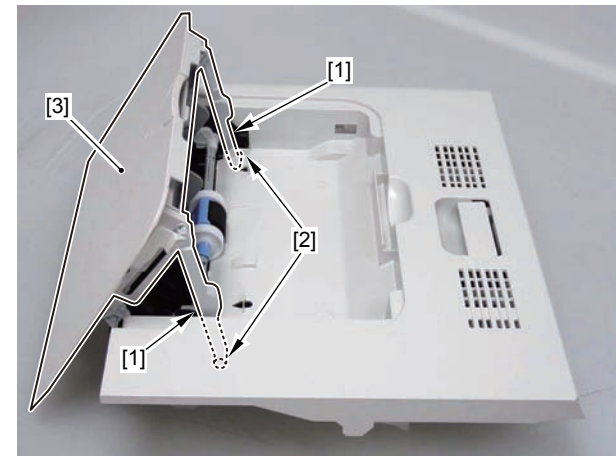

F-3-183

5) Remove the shaft [1] from the shaft support [2] in 2 places and remove the feed unit cover [3].

Caution:

Do not lost the spring [4].

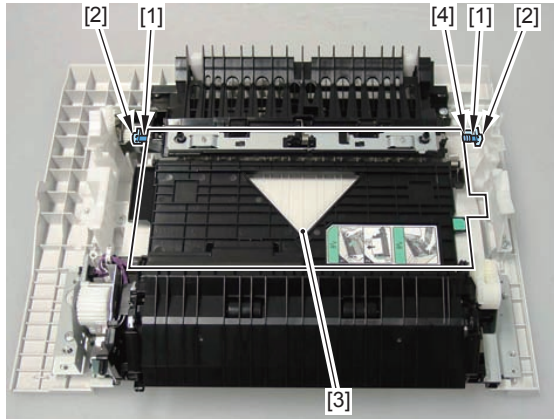

F-3-184

6) Remove the plate [1] and remove the 2 connectors [2].

- 1 screw [3]
- 1 spring [4]

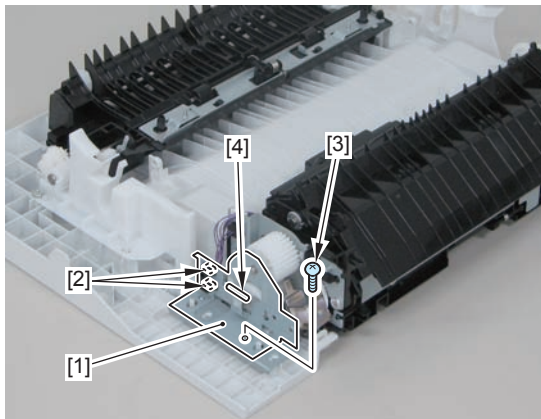

F-3-185

7) Remove the spring [1] and the gear [2].

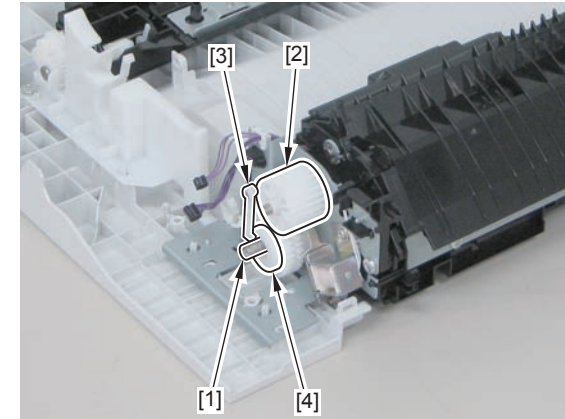

F-3-186

MEMO :

When installing the spring, install the gear first and then, install the spring to the center of the gear.

8) Remove the plate [1].

- 1 screw [2]

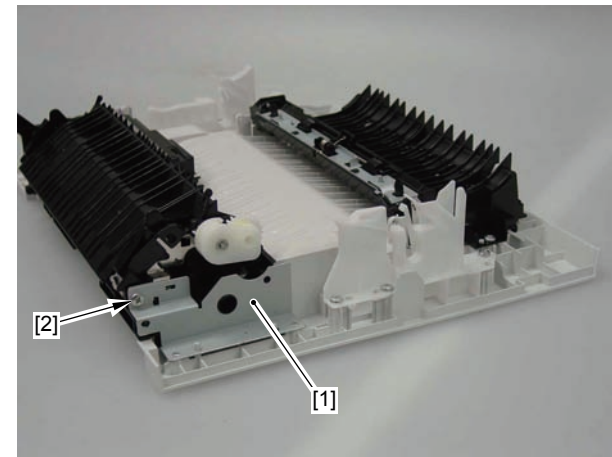

F-3-187

9) Disengage the plate [1] from the boss and slide the multi-purpose tray pickup unit [2] in the direction of the arrow.

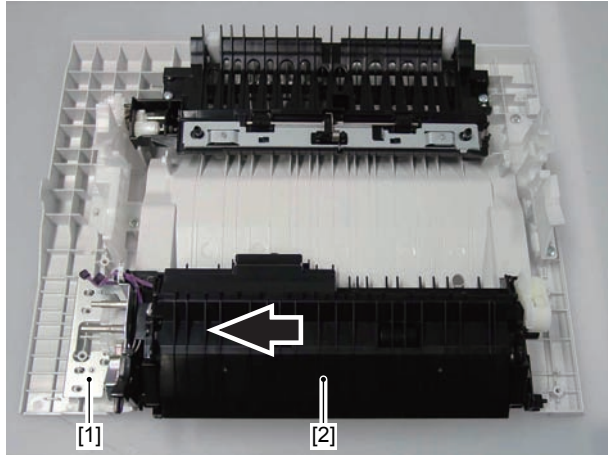

F-3-188

Removing the Auto Close Unit(LBP7780C/LBP5480)

Before Removing the Auto Close Unit

- 1) Remove the left cover.(Refer to page 3-11)
- 2) Remove the rear cover.(Refer to page 3-12)
- 3) Remove the right rear cover.(Refer to page 3-13)
- 4) Remove the main controller PCB.(Refer to page 3-101)
- 5) Remove the low voltage power unit.(Refer to page 3-109)
- 6) Remove the lower high voltage power supply PCB.(Refer to page 3-115)
- 7) Remove the lifter drive unit.(Refer to page 3-40)

Removing the Auto Close Unit

- 1) Remove the auto close unit [1].
 - 1 screw [2]
 - 2 hooks[3]

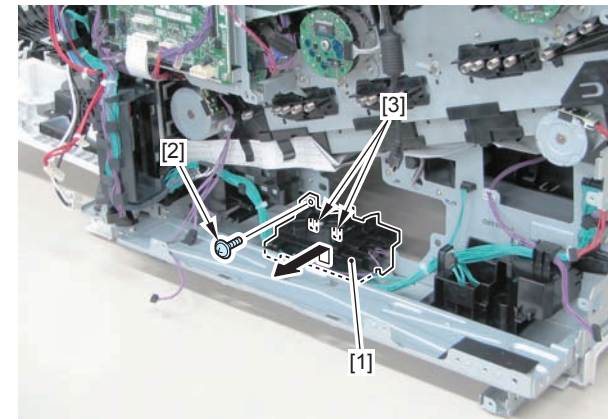

F-3-189

Main Parts

Removing the Cassette Pickup Roller

Before Removing the Cassette Pickup Roller

- 1) Open the Front Cover Unit.
- 2) Remove all the Toner Cartridges.
- 3) Close the Front Cover Unit.

Caution :

To prevent the toner dirt in the machine, do not remove the following parts.

- ITB Unit
- Waste Toner Container

Removing the Cassette Pickup Roller

- 1) Remove the cassette.
- 2) Tilt the host machine to the side in the way where the front cover unit is face-up.
- 3) Push the stopper [1] to the upper.

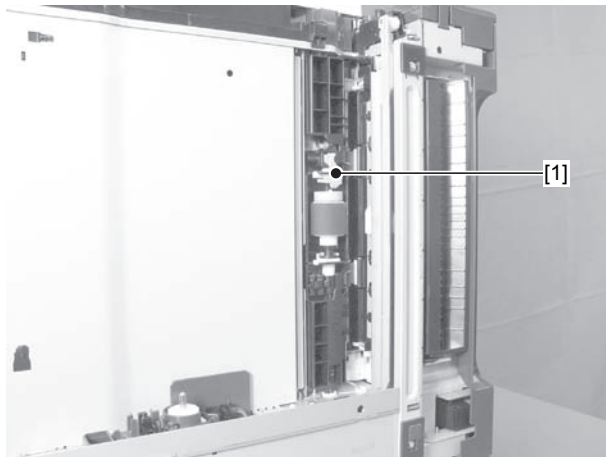

F-3-190

- 4) Shift it upward and remove the Cassette Pickup Roller [1].

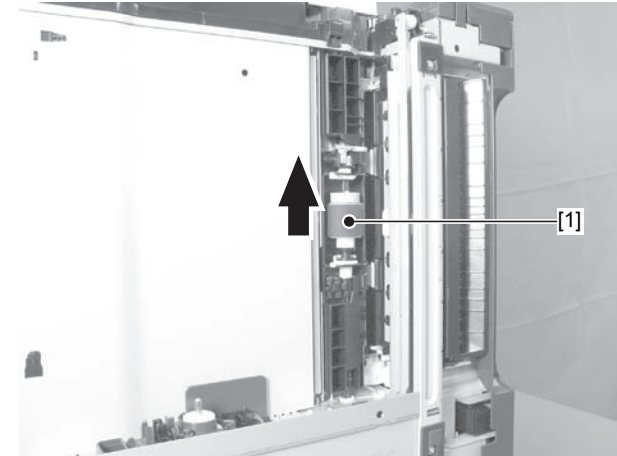

F-3-191

Caution :

Do not touch the roller surface [1] of the cassette pickup roller.

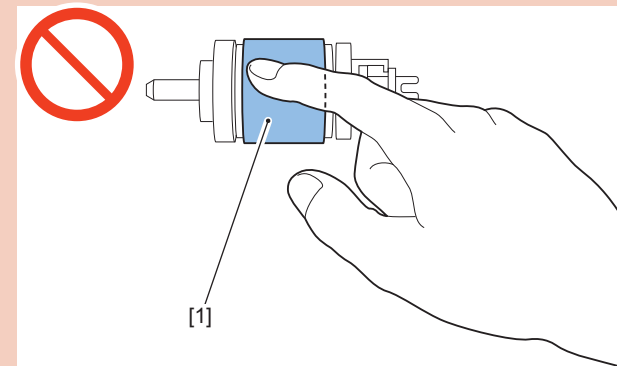

F-3-192

Removing the Cassette Pickup Roller(LBP7780C/LBP5480)

Before Removing the Cassette Pickup Roller

- 1) Open the Front Cover Unit.
- 2) Remove all the Toner Cartridges.
- 3) Close the Front Cover Unit.

Caution :

To prevent the toner dirt in the machine, do not remove the following parts.

- ITB Unit
- Waste Toner Container

Removing the Cassette Pickup Roller

- 1) Remove the cassette.
- 2) Tilt the host machine to the side in the way where the front cover unit is face-up.
- 3) Push the stopper [1] to the upper.

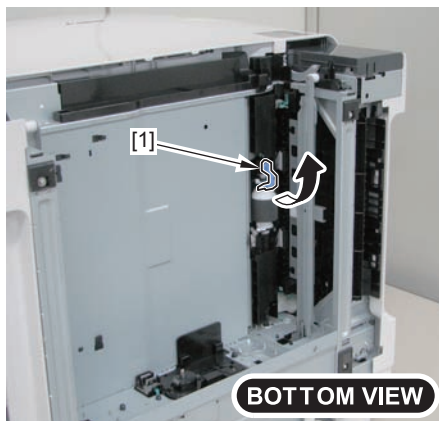

BOTTOM VIEW

F-3-193

- 4) Shift it upward and remove the Cassette Pickup Roller [1].

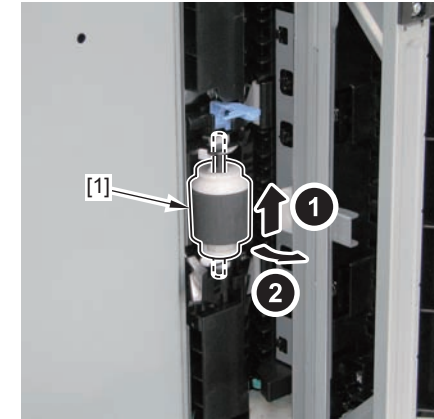

F-3-194

Caution :

Do not touch the roller surface [1] of the cassette pickup roller.

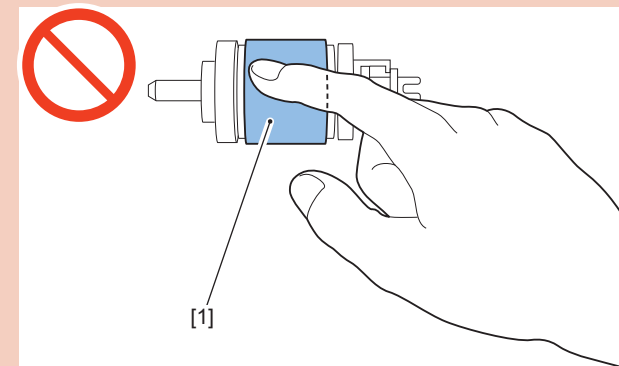

F-3-195

Removing the Cassette Separation Roller Assembly

1) Remove the cassette.

Caution :

Do not touch the roller surface [1] of the cassette separation roller assembly.

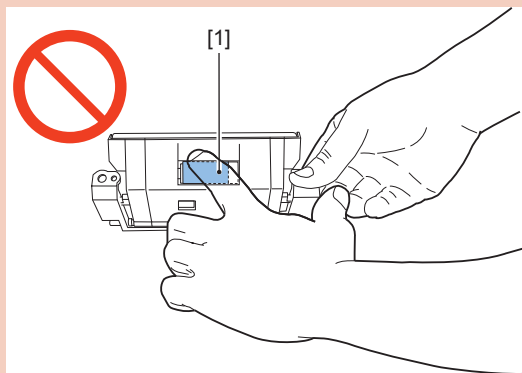

F-3-196

2) Remove the cassette separation roller assembly [1].

- 2 screws [2]

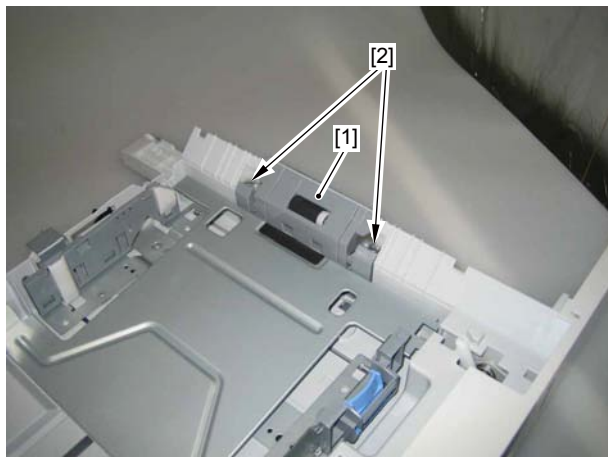

F-3-197

Removing the Power Fan

Before Removing the Power Fan

- 1) Remove the left cover. (Refer to page 3-11)
- 2) Remove the rear cover. (Refer to page 3-12)
- 3) Remove the right rear cover. (Refer to page 3-13)

Removing the Power Fan

- 1) Remove the plate [1].
 - 1 screw [2]

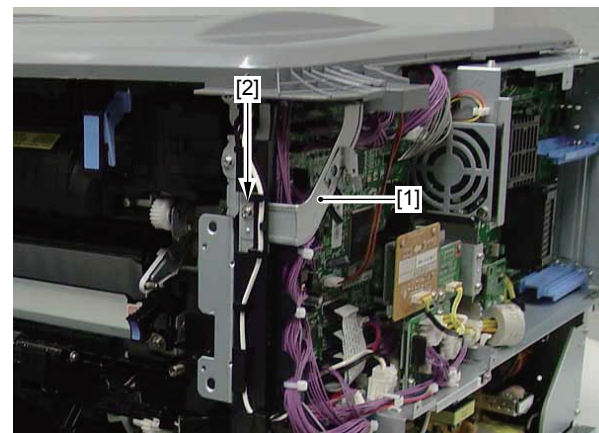

F-3-198

2) Remove the 6 connectors [1].

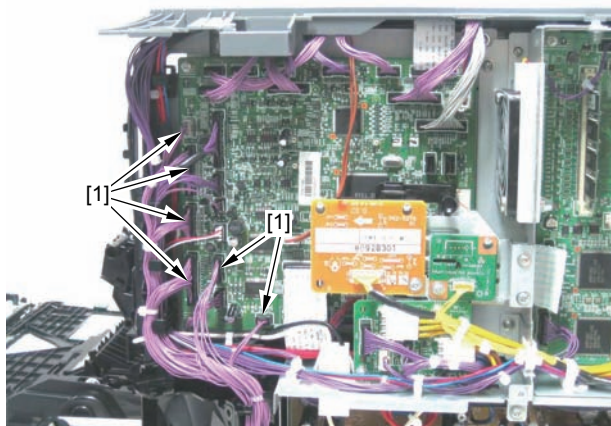

F-3-199

3) Remove the harness [2] from the harness guide [1].

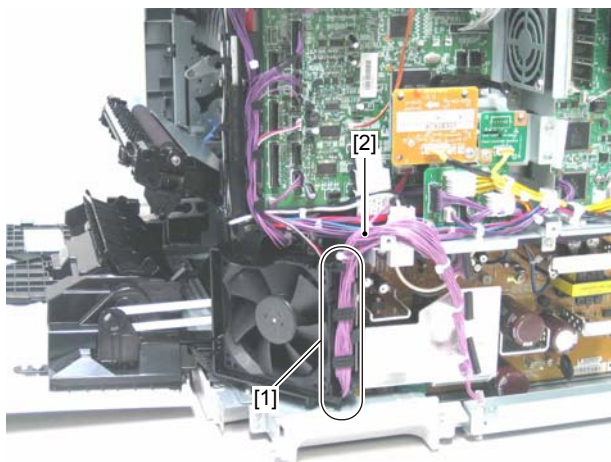

F-3-200

4) Remove the connector [1] and the screw [2].

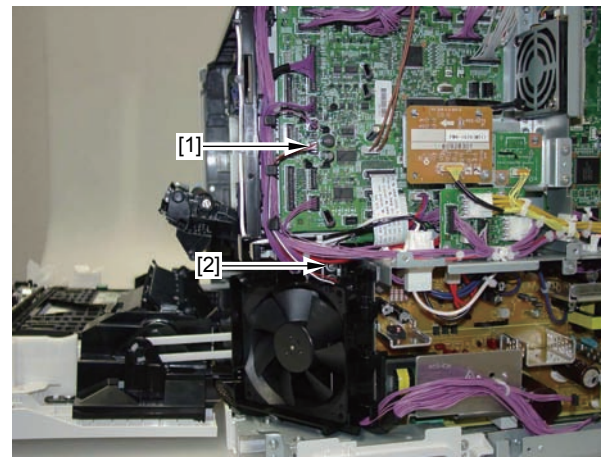

F-3-201

5) Remove the power fan [1].

- 1 claw [2]

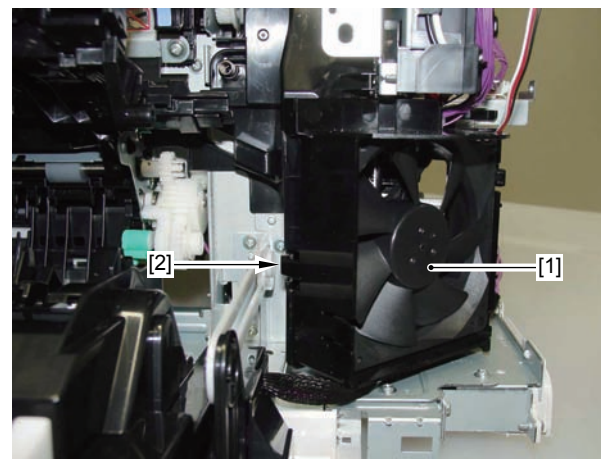

F-3-202

Removing the Power Fan(LBP7780C/LBP5480)

Before Removing the Power Fan

- 1) Remove the left cover.(Refer to page 3-11)
- 2) Remove the rear cover.(Refer to page 3-12)
- 3) Remove the right rear cover.(Refer to page 3-13)

Removing the Power Fan

- 1) Remove the plate [1].
 - 1 screw [2]

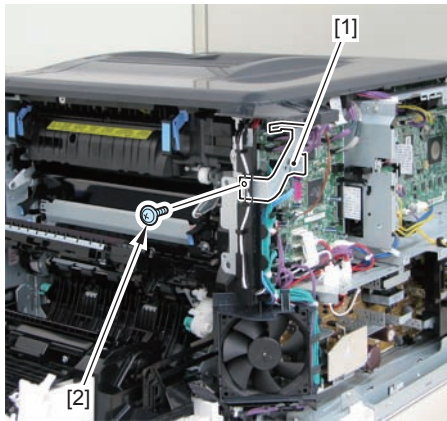

F-3-203

- 2) Remove the 6 connectors [1].

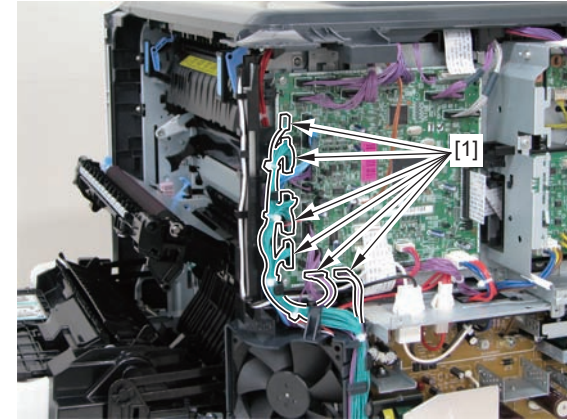

F-3-204

- 3) Remove the harness [2] from the harness guide [1].

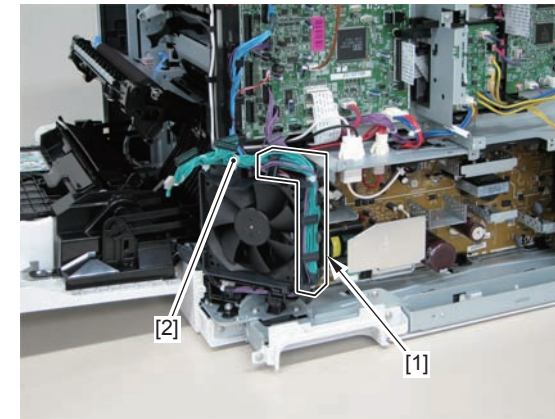

F-3-205

4) Remove the connector [1] and the screw [2].

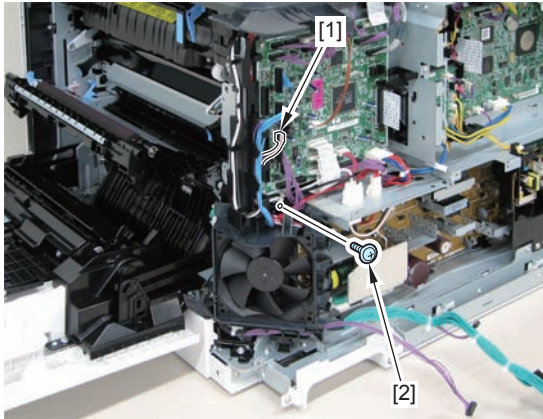

F-3-206

5) Remove the power fan [1].

- 1 claw [2]

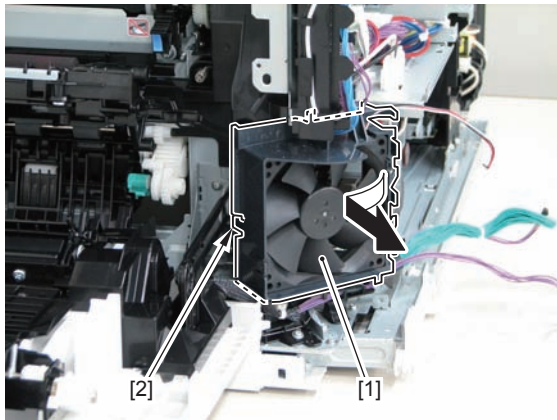

F-3-207

Removing the Fan Unit

Before Removing the Fan Unit

- 1) Remove the left cover. (Refer to page 3-11)
- 2) Remove the rear cover. (Refer to page 3-12)
- 3) Remove the right rear cover. (Refer to page 3-13)
- 4) Remove the ICB PCB. (Refer to page 3-101)
- 5) Remove the main controller PCB. (Refer to page 3-101)
- 6) Remove the low voltage power unit. (Refer to page 3-109)
- 7) Remove the lower high voltage power supply PCB. (Refer to page 3-115)

Removing the Fan Unit

1) Remove the plate [1].

- 1 screw [2]

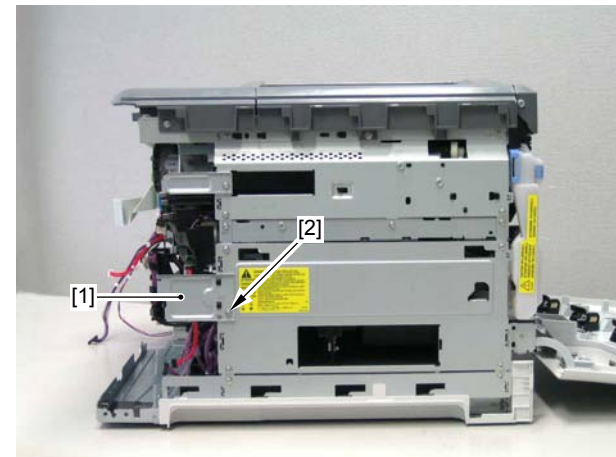

F-3-208

2) Remove the plate [1].

- 4 screws [2]

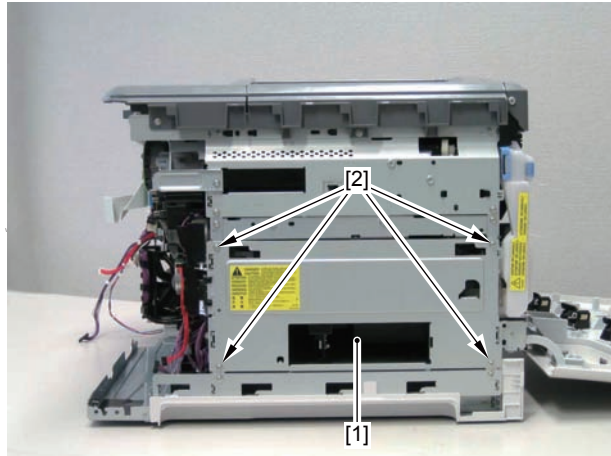

F-3-209

3) Remove the 5 connectors [1][2][3].

[1] : Remove toward the upper.

[2] : Remove toward the lower.

[3] : Connector with claw

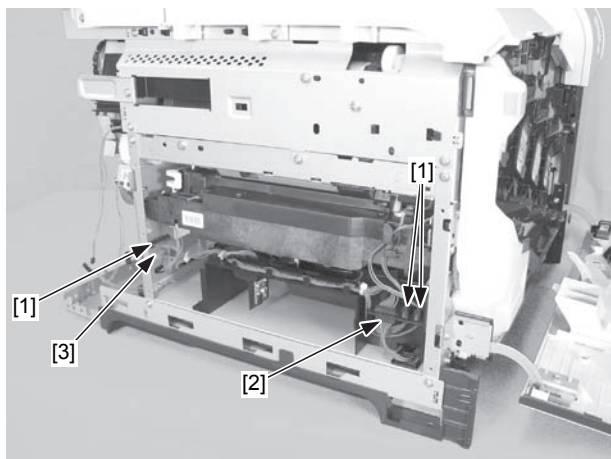

F-3-210

4) Slide the fan unit [1] in the direction of the arrow and remove it.

- 2 claws [2]

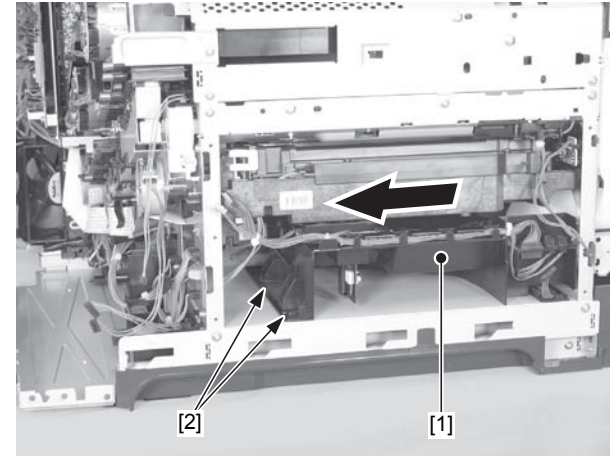

F-3-211

Removing the Fan Unit(LBP7780C/LBP5480)

Before Removing the Fan Unit

- 1) Remove the left cover.(Refer to page 3-11)
- 2) Remove the rear cover.(Refer to page 3-12)
- 3) Remove the right rear cover.(Refer to page 3-13)
- 4) Remove the main controller PCB.(Refer to page 3-101)
- 5) Remove the low voltage power unit.(Refer to page 3-109)
- 6) Remove the lower high voltage power supply PCB.(Refer to page 3-115)

Removing the Fan Unit

- 1) Remove the plate [1].
 - 1 screw [2]

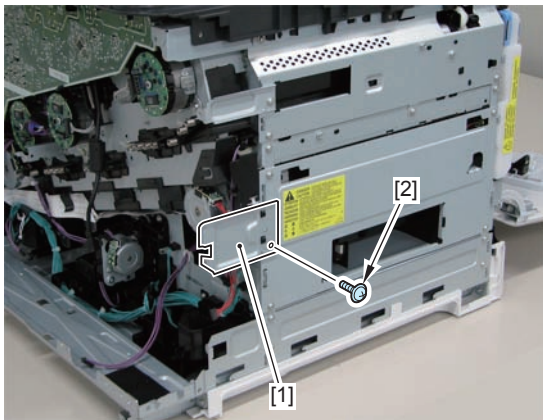

F-3-212

- 2) Remove the plate [1].
 - 4 screws [2]

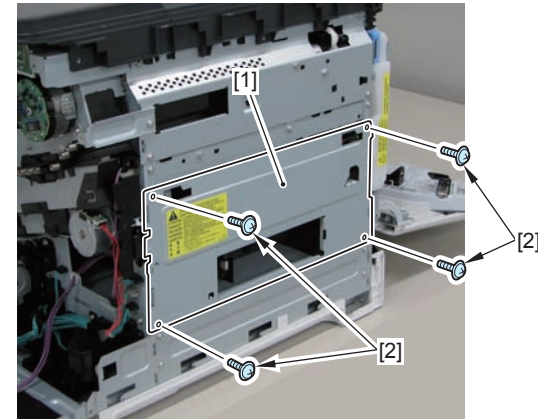

F-3-213

- 3) Remove the 5 connectors [1][2][3].
 - [1] : Remove toward the upper.
 - [2] : Remove toward the lower.
 - [3] : Connector with claw

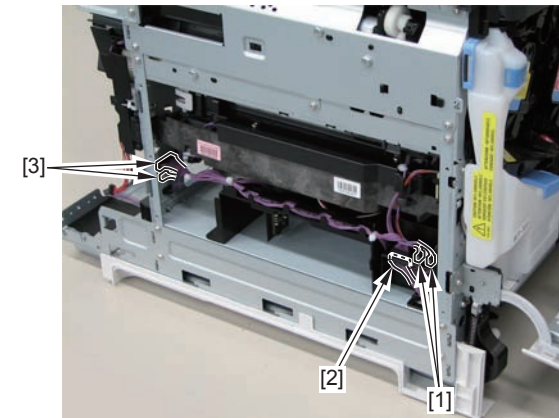

F-3-214

4) Slide the fan unit [1] in the direction of the arrow and remove it.

- 2 claws [2]

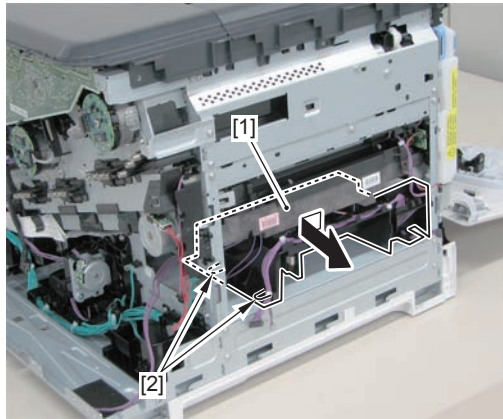

F-3-215

Removing the Developing Disengagement Motor

Before Removing the Developing Disengagement Motor

- 1) Remove the left cover. (Refer to page 3-11)
- 2) Remove the rear cover. (Refer to page 3-12)
- 3) Remove the right rear cover. (Refer to page 3-13)
- 4) Remove the ICB PCB. (Refer to page 3-101)
- 5) Remove the main controller PCB. (Refer to page 3-101)
- 6) Remove the low voltage power unit. (Refer to page 3-109)
- 7) Remove the lower high voltage power supply PCB. (Refer to page 3-115)

Removing the Developing Disengagement Motor

- 1) Remove the developing disengagement motor [1].
 - 2 screws [2]
 - 1 connector [3]

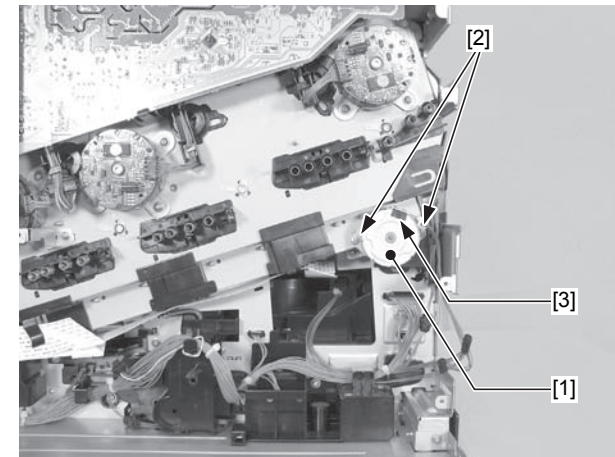

F-3-216

Removing the Developing Disengagement Motor(LBP7780C/LBP5480)

Before Removing the Developing Disengagement Motor

- 1) Remove the left cover.(Refer to page 3-11)
- 2) Remove the right rear cover.(Refer to page 3-13)
- 3) Remove the rear cover.(Refer to page 3-12)
- 4) Remove the main controller PCB.(Refer to page 3-101)
- 5) Remove the low voltage power unit.(Refer to page 3-109)
- 6) Remove the lower high voltage power supply PCB.(Refer to page 3-115)

Removing the Developing Disengagement Motor

- 1) Remove the developing disengagement motor [1].
 - 2 screws [2]

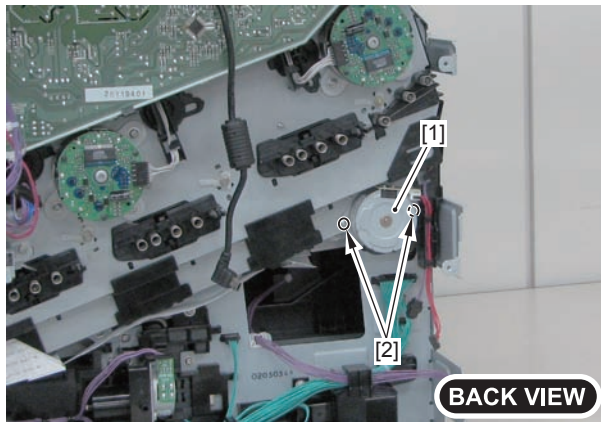

F-3-217

Removing the Secondary Transfer Outer Roller Unit

Caution :

Do not touch the roller surface [1] of the secondary transfer outer roller.

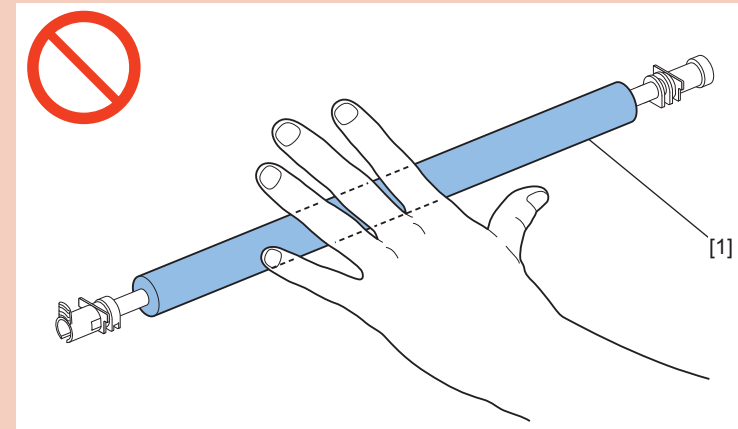

F-3-218

- 1) Open the right cover unit.
- 2) Push the arm [1] downward and lower the secondary transfer unit [2].

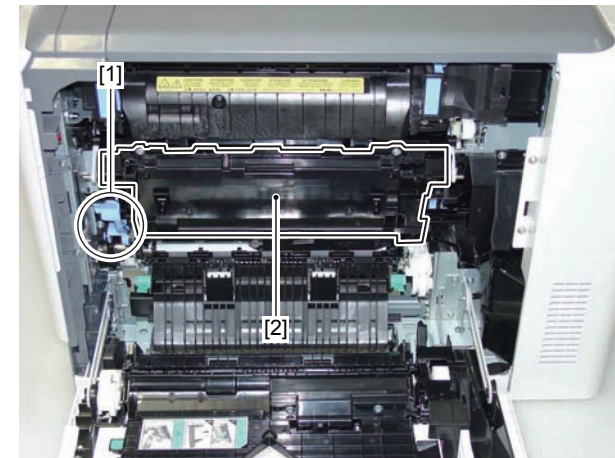

F-3-219

3) Hold the both sides [1] of the Secondary Transfer Outer Roller Unit and remove it in the direction of the arrow.

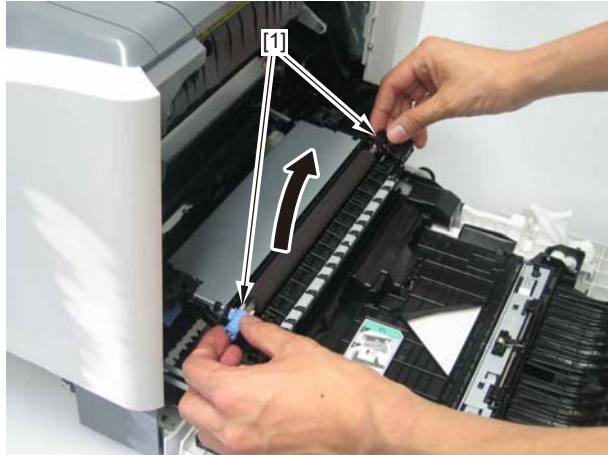

F-3-220

Caution :

Make sure to install the new secondary transfer outer roller unit before removing the protection sheet [1].

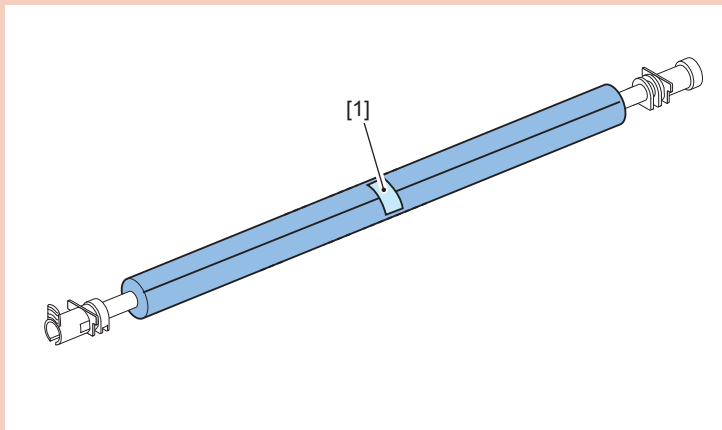

F-3-221

Removing the Pickup Motor

Before Removing the Pickup Motor

- 1) Remove the left cover. (Refer to page 3-11)
- 2) Remove the rear cover. (Refer to page 3-12)
- 3) Remove the right rear cover. (Refer to page 3-13)
- 4) Remove the ICB PCB. (Refer to page 3-101)
- 5) Remove the main controller PCB. (Refer to page 3-101)
- 6) Remove the low voltage power unit. (Refer to page 3-109)
- 7) Remove the lower high voltage power supply PCB. (Refer to page 3-115)

Removing the Pickup Motor

- 1) Remove the flat cable [1] from the harness guide.
 - 2 connectors [2]

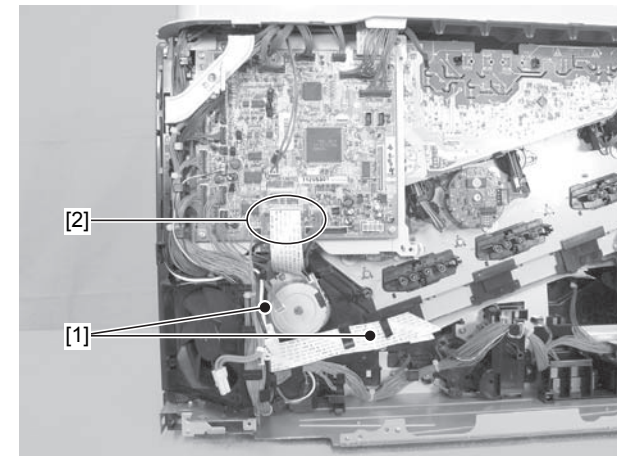

F-3-222

2) Remove the pickup motor [1].

- 2 screws [2]
- 1 connector [3]

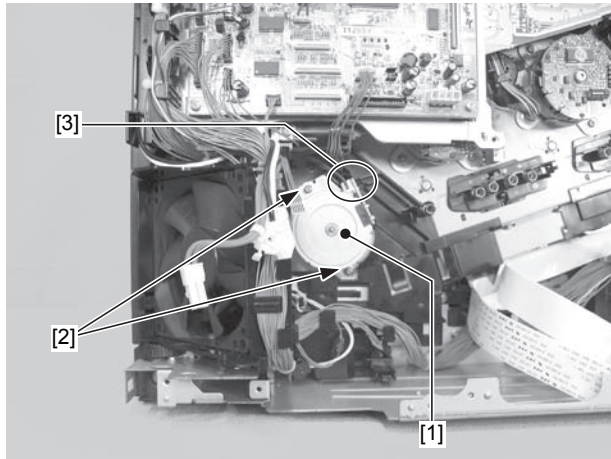

F-3-223

Removing the Pickup Motor(LBP7780C/LBP5480)

Before Removing the Pickup Motor

- 1) Remove the left cover. (Refer to page 3-11)
- 2) Remove the right rear cover. (Refer to page 3-13)
- 3) Remove the rear cover. (Refer to page 3-12)
- 4) Remove the main controller PCB. (Refer to page 3-101)
- 5) Remove the low voltage power unit. (Refer to page 3-109)
- 6) Remove the lower high voltage power supply PCB. (Refer to page 3-115)

Removing the Pickup Motor

- 1) Remove the flat cable [1] from the harness guide.
 - 2 connectors [2]

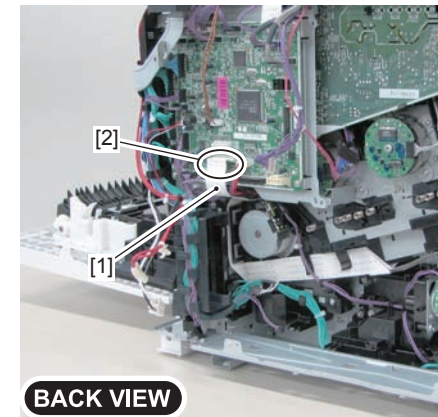

F-3-224

Removing the Drum Motor 1

Before Removing the Drum Motor 1

- 1) Remove the left cover.(Refer to page 3-11)
- 2) Remove the rear cover.(Refer to page 3-12)
- 3) Remove the right rear cover.(Refer to page 3-13)
- 4) Remove the ICB PCB.(Refer to page 3-101)
- 5) Remove the main controller PCB.(Refer to page 3-101)
- 6) Remove the low voltage power unit.(Refer to page 3-109)
- 7) Remove the lower high voltage power supply PCB.(Refer to page 3-115)
- 8) Remove the control panel unit right cover.(Refer to page 3-14)
- 9) Remove the control panel unit left cover.(Refer to page 3-15)
- 10) Remove the upper front cover unit.(Refer to page 3-16)
- 11) Remove the upper rear cover.(Refer to page 3-21)
- 12) Remove the upper high voltage power supply PCB.(Refer to page 3-119)

Removing the Drum Motor 1

- 1) Remove the drum motor 1 [1].
 - 4 screws [2]

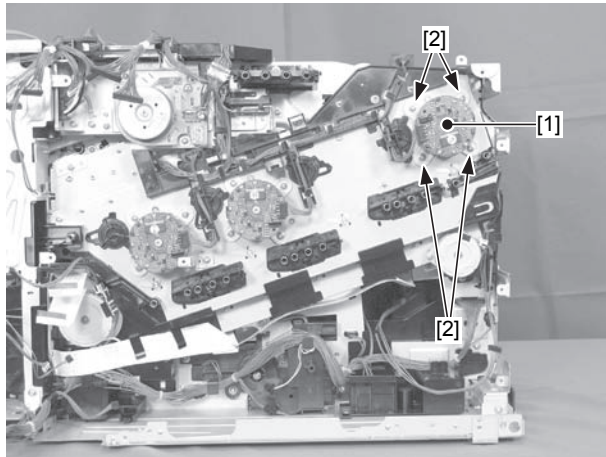

F-3-225

Removing the Drum Motor 1(LBP7780C/LBP5480)

Before Removing the Drum Motor 1

- 1) Remove the left cover.(Refer to page 3-11)
- 2) Remove the right rear cover.(Refer to page 3-13)
- 3) Remove the rear cover.(Refer to page 3-12)
- 4) Remove the main controller PCB.(Refer to page 3-101)
- 5) Remove the low voltage power unit.(Refer to page 3-109)
- 6) Remove the lower high voltage power supply PCB.(Refer to page 3-115)
- 7) Remove the control panel unit right cover.(Refer to page 3-14)
- 8) Remove the control panel unit left cover.(Refer to page 3-15)
- 9) Remove the upper front cover unit.(Refer to page 3-16)
- 10) Remove the upper rear cover.(Refer to page 3-21)
- 11) Remove the upper high voltage power supply PCB.(Refer to page 3-119)

Removing the Drum Motor 1

- 1) Remove the drum motor 1 [1].
 - 4 screws [2]
 - 1 connector[3]

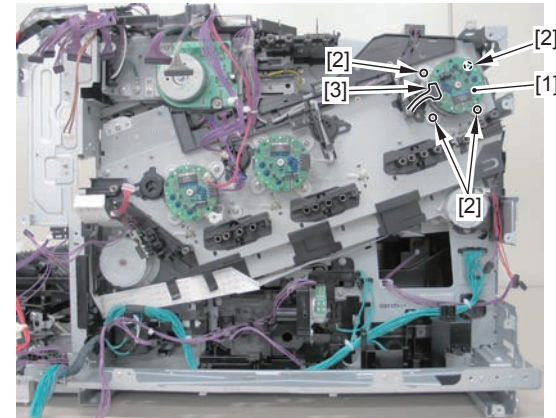

F-3-226

Removing the Drum Motor 2

Before Removing the Drum Motor 2

- 1) Remove the left cover.(Refer to page 3-11)
- 2) Remove the rear cover.(Refer to page 3-12)
- 3) Remove the right rear cover.(Refer to page 3-13)
- 4) Remove the ICB PCB.(Refer to page 3-101)
- 5) Remove the main controller PCB.(Refer to page 3-101)
- 6) Remove the low voltage power unit.(Refer to page 3-109)
- 7) Remove the control panel unit right cover.(Refer to page 3-14)
- 8) Remove the control panel unit left cover.(Refer to page 3-15)
- 9) Remove the upper front cover unit.(Refer to page 3-16)
- 10) Remove the upper rear cover.(Refer to page 3-21)
- 11) Remove the upper high voltage power supply PCB.(Refer to page 3-119)

Removing the Drum Motor 2

- 1) Remove the drum motor 2 [1].
 - 4 screws [2]

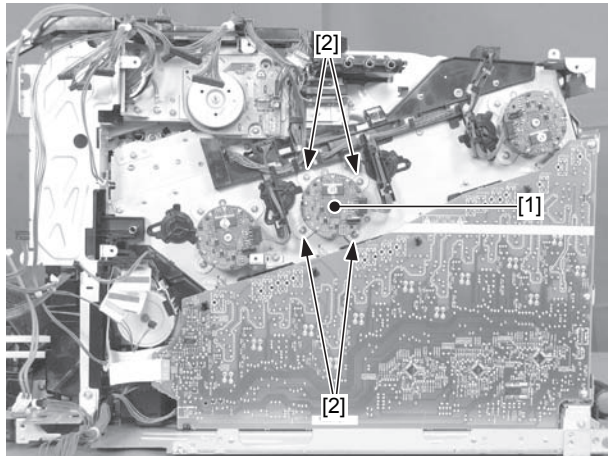

F-3-227

Removing the Drum Motor 2(LBP7780C/LBP5480)

Before Removing the Drum Motor 2

- 1) Remove the left cover.(Refer to page 3-11)
- 2) Remove the right rear cover.(Refer to page 3-13)
- 3) Remove the rear cover.(Refer to page 3-12)
- 4) Remove the main controller PCB.(Refer to page 3-101)
- 5) Remove the low voltage power unit.(Refer to page 3-109)
- 6) Remove the control panel unit right cover.(Refer to page 3-14)
- 7) Remove the control panel unit left cover.(Refer to page 3-15)
- 8) Remove the upper front cover unit.(Refer to page 3-16)
- 9) Remove the upper rear cover.(Refer to page 3-21)
- 10) Remove the upper high voltage power supply PCB.(Refer to page 3-119)

Removing the Drum Motor 2

- 1) Remove the drum motor 2 [1].
 - 4 screws [2]
 - 1 connector[3]

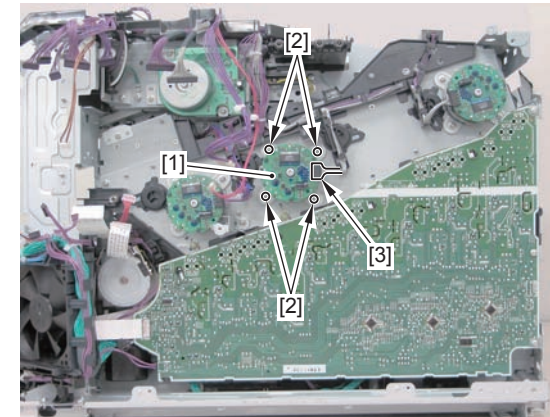

F-3-228

Removing the Drum Motor 3

Before Removing the Drum Motor 3

- 1) Remove the left cover.(Refer to page 3-11)
- 2) Remove the rear cover.(Refer to page 3-12)
- 3) Remove the right rear cover.(Refer to page 3-13)
- 4) Remove the ICB PCB.(Refer to page 3-101)
- 5) Remove the main controller PCB.(Refer to page 3-101)
- 6) Remove the low voltage power unit.(Refer to page 3-109)
- 7) Remove the control panel unit right cover.(Refer to page 3-14)
- 8) Remove the control panel unit left cover.(Refer to page 3-15)
- 9) Remove the upper front cover unit.(Refer to page 3-16)
- 10) Remove the upper rear cover.(Refer to page 3-21)
- 11) Remove the upper high voltage power supply PCB.(Refer to page 3-119)

Removing the Drum Motor 3

- 1) Remove the drum motor 3 [1].
 - 4 screws [2]

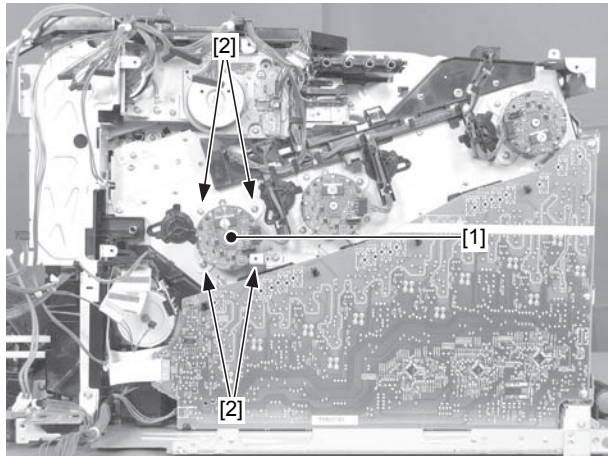

F-3-229

Removing the Drum Motor 3(LBP7780C/LBP5480)

Before Removing the Drum Motor 3

- 1) Remove the left cover.(Refer to page 3-11)
- 2) Remove the right rear cover.(Refer to page 3-13)
- 3) Remove the rear cover.(Refer to page 3-12)
- 4) Remove the main controller PCB.(Refer to page 3-101)
- 5) Remove the low voltage power unit.(Refer to page 3-109)
- 6) Remove the control panel unit right cover.(Refer to page 3-14)
- 7) Remove the control panel unit left cover.(Refer to page 3-15)
- 8) Remove the upper front cover unit.(Refer to page 3-16)
- 9) Remove the upper rear cover.(Refer to page 3-21)
- 10) Remove the upper high voltage power supply PCB.(Refer to page 3-119)

Removing the Drum Motor 3

- 1) Remove the drum motor 3 [1].
 - 4 screws [2]
 - 1 connector[3]

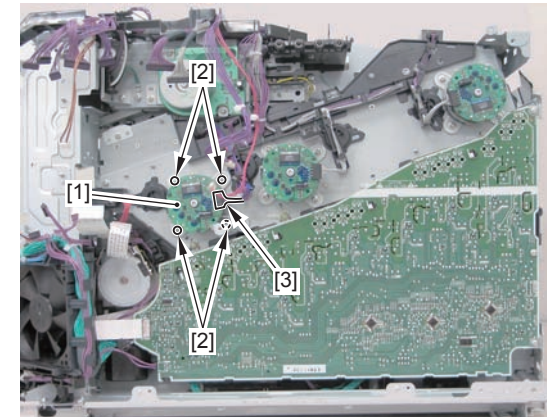

F-3-230

Removing the Fixing Motor

Before Removing the Fixing Motor

- 1) Remove the left cover.(Refer to page 3-11)
- 2) Remove the rear cover.(Refer to page 3-12)
- 3) Remove the right rear cover.(Refer to page 3-13)
- 4) Remove the ICB PCB.(Refer to page 3-101)
- 5) Remove the main controller PCB.(Refer to page 3-101)
- 6) Remove the low voltage power unit.(Refer to page 3-109)
- 7) Remove the control panel unit right cover.(Refer to page 3-14)
- 8) Remove the control panel unit left cover.(Refer to page 3-15)
- 9) Remove the upper front cover unit.(Refer to page 3-16)
- 10) Remove the upper rear cover.(Refer to page 3-21)
- 11) Remove the upper high voltage power supply PCB.(Refer to page 3-119)

Removing the Fixing Motor

- 1) Remove the fixing motor [1].
 - 1 connector [2]
 - 3 screws [3]

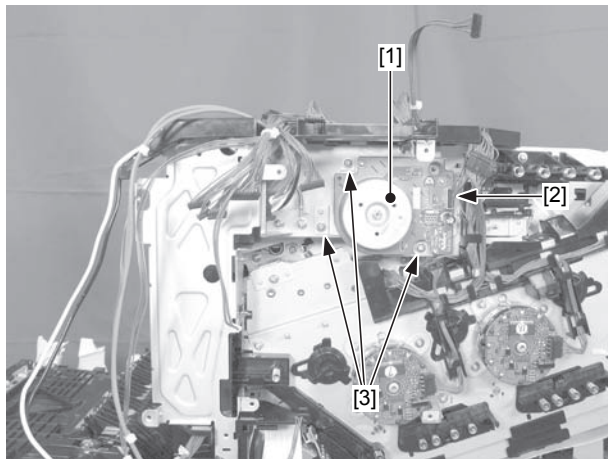

F-3-231

Removing the Fixing Motor(LBP7780C/LBP5480)

Before Removing the Fixing Motor

- 1) Remove the left cover.(Refer to page 3-11)
- 2) Remove the right rear cover.(Refer to page 3-13)
- 3) Remove the rear cover.(Refer to page 3-12)
- 4) Remove the main controller PCB.(Refer to page 3-101)
- 5) Remove the low voltage power unit.(Refer to page 3-109)
- 6) Remove the control panel unit right cover.(Refer to page 3-14)
- 7) Remove the control panel unit left cover.(Refer to page 3-15)
- 8) Remove the upper front cover unit.(Refer to page 3-16)
- 9) Remove the upper rear cover.(Refer to page 3-21)
- 10) Remove the upper high voltage power supply PCB.(Refer to page 3-119)

Removing the Fixing Motor

- 1) Remove the fixing motor [1].
 - 1 connector [2]
 - 3 screws [3]

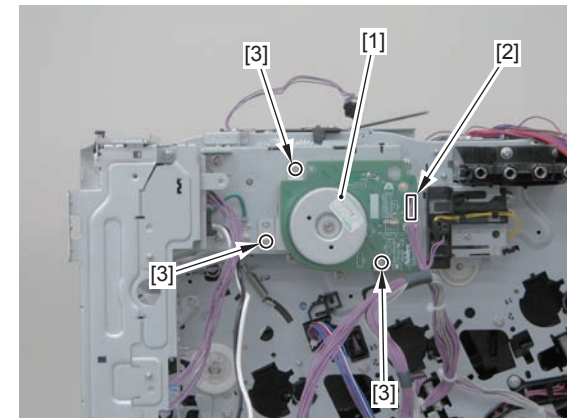

F-3-232

Removing the Delivery Fan

Before Removing the Delivery Fan

- 1) Remove the left cover. (Refer to page 3-11)
- 2) Remove the rear cover. (Refer to page 3-12)
- 3) Remove the right rear cover. (Refer to page 3-13)
- 4) Remove the ICB PCB. (Refer to page 3-101)
- 5) Remove the main controller PCB. (Refer to page 3-101)
- 6) Remove the low voltage power unit. (Refer to page 3-109)
- 7) Remove the lower high voltage power supply PCB. (Refer to page 3-115)
- 8) Remove the fan unit. (Refer to page 3-82)

Removing the Delivery Fan

- 1) Remove the cover [1].
 - 1 screw [2]

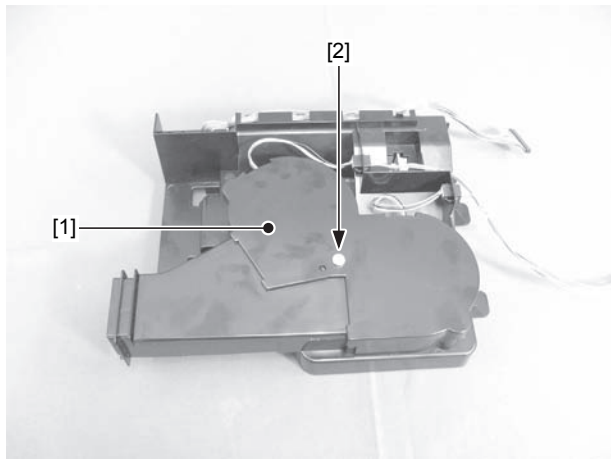

F-3-233

- 2) Remove the delivery fan [1].
 - 1 connector [2]

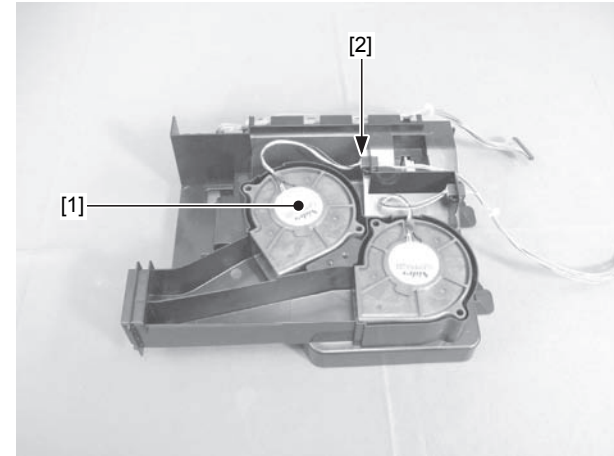

F-3-234

Removing the Delivery Fan(LBP7780C/LBP5480)

Before Removing the Delivery Fan

- 1) Remove the left cover. (Refer to page 3-11)
- 2) Remove the right rear cover. (Refer to page 3-13)
- 3) Remove the rear cover. (Refer to page 3-12)
- 4) Remove the main controller PCB. (Refer to page 3-101)
- 5) Remove the low voltage power unit. (Refer to page 3-109)
- 6) Remove the lower high voltage power supply PCB. (Refer to page 3-115)
- 7) Remove the fan unit. (Refer to page 3-84)

Removing the Delivery Fan

- 1) Remove the cover [1].
 - 1 screw [2]

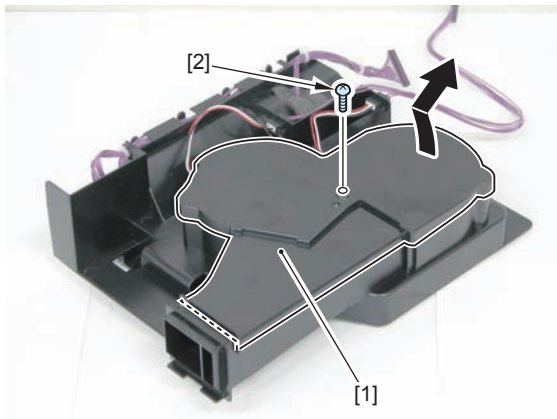

F-3-235

- 2) Remove the delivery fan [1].
 - 1 connector [2]

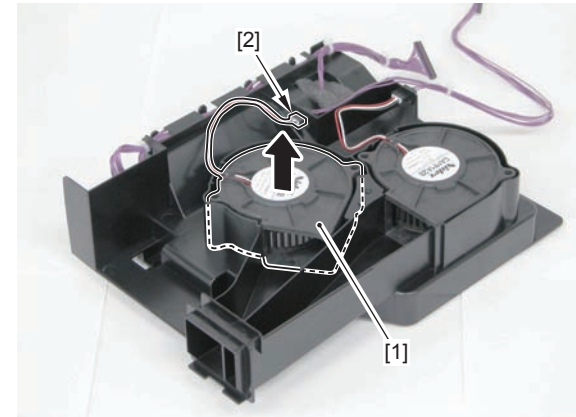

F-3-236

Removing the Cartridge Fan

Before Removing the Cartridge Fan

- 1) Remove the left cover. (Refer to page 3-11)
- 2) Remove the rear cover. (Refer to page 3-12)
- 3) Remove the right rear cover. (Refer to page 3-13)
- 4) Remove the ICB PCB. (Refer to page 3-101)
- 5) Remove the main controller PCB. (Refer to page 3-101)
- 6) Remove the low voltage power unit. (Refer to page 3-109)
- 7) Remove the lower high voltage power supply PCB. (Refer to page 3-115)
- 8) Remove the fan unit. (Refer to page 3-82)

Removing the Cartridge Fan

- 1) Remove the cover [1].
 - 1 screw [2]

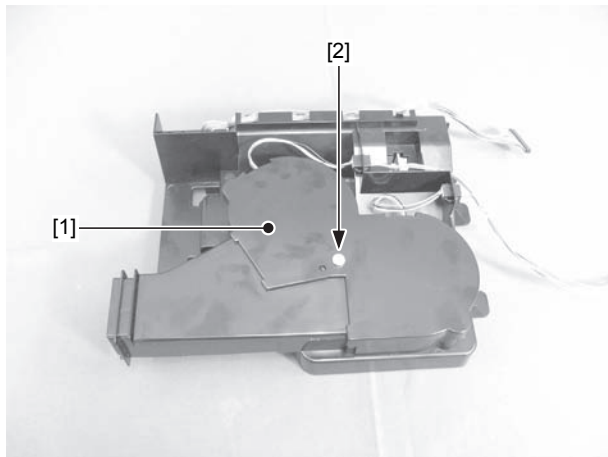

F-3-237

- 2) Remove the cartridge fan [1].

- 1 connector [2]

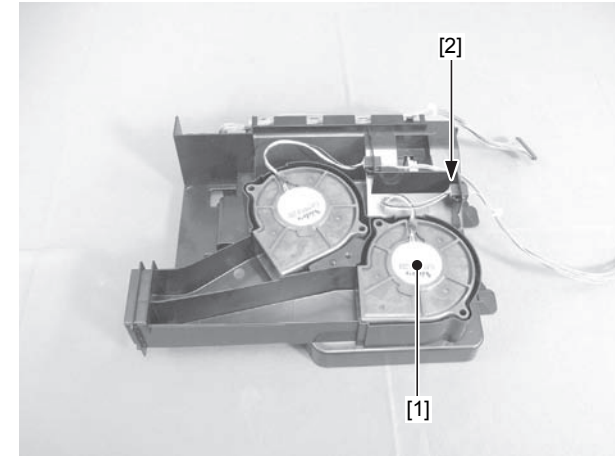

F-3-238

Removing the Cartridge Fan(LBP7780C/LBP5480)

- 1) Remove the left cover.(Refer to page 3-11)
- 2) Remove the rear cover.(Refer to page 3-12)
- 3) Remove the right rear cover.(Refer to page 3-13)
- 4) Remove the main controller PCB.(Refer to page 3-101)
- 5) Remove the low voltage power unit.(Refer to page 3-109)
- 6) Remove the lower high voltage power supply PCB.(Refer to page 3-115)
- 7) Remove the fan unit.(Refer to page 3-84)

Removing the Cartridge Fan

- 1) Remove the cover [1].
 - 1 screw [2]

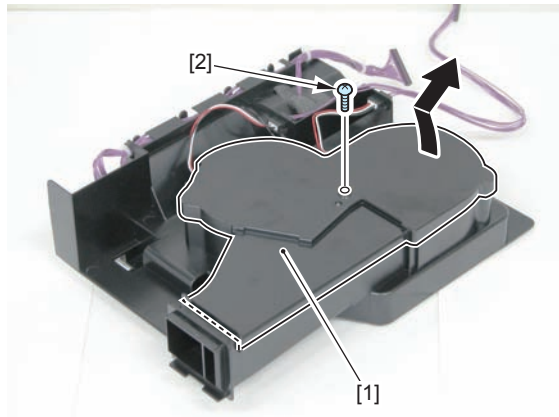

F-3-239

- 2) Remove the cartridge fan [1].
 - 1 connector [2]

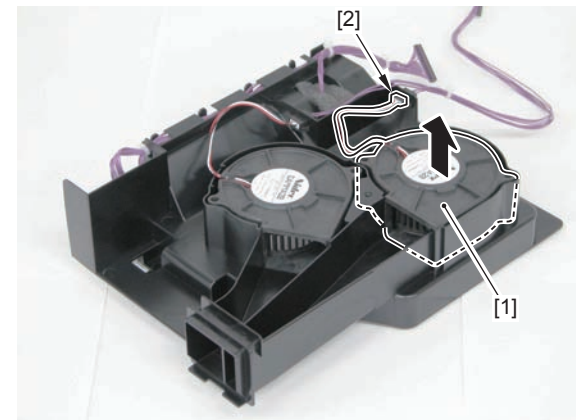

F-3-240

Removing the Multi-purpose Tray Pickup Roller

Caution :

Do not touch the roller surface [1] of the multi-purpose tray pickup roller.

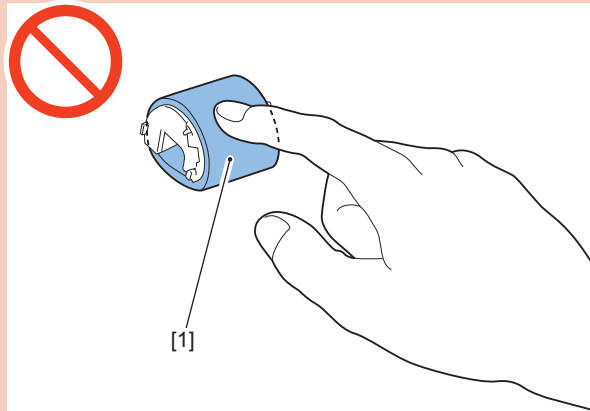

F-3-241

- 1) Open the manual pickup tray.
- 2) Remove the cover [1].
 - 2 claws [2]

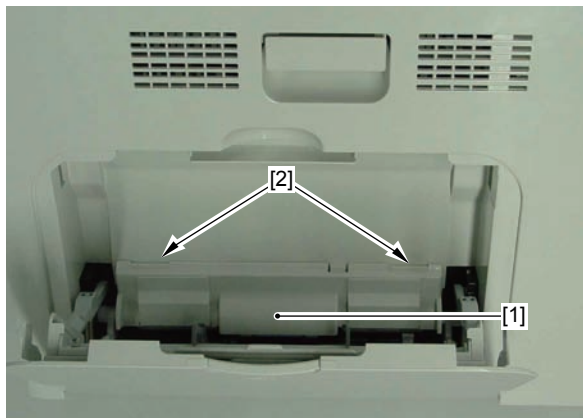

F-3-242

- 3) Open the pickup roller retainer [1] to the right and left and remove the multi-purpose tray pickup roller [2] in the direction of the arrow.

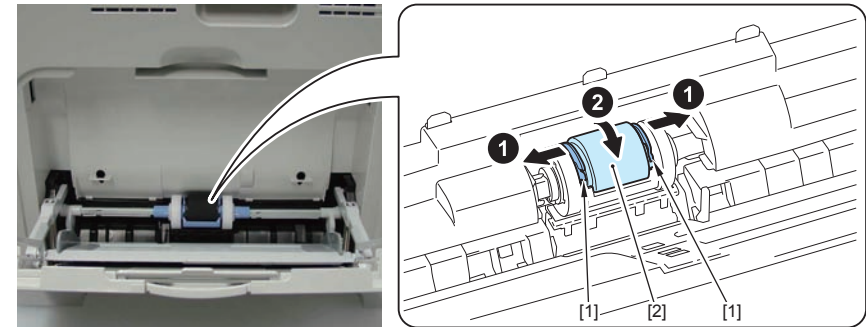

F-3-243

Points to note when installing the multi-purpose tray pickup roller :

After installation, make sure that the protrusion [1] of the multi-purpose tray pickup roller fitted into the hole [2] of the pickup roller retainer.

Check that the multi-purpose tray pickup roller does not come off.

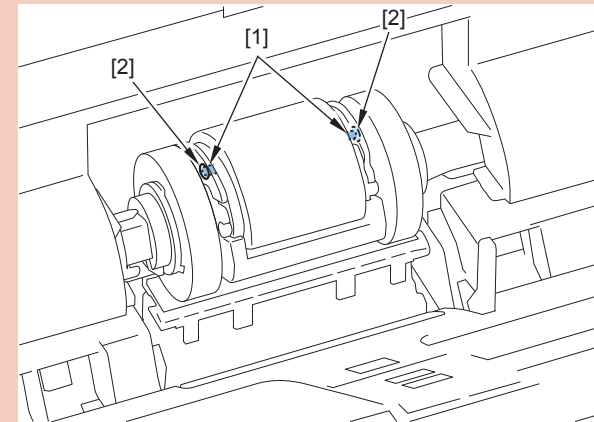

F-3-244

Removing the Multi-purpose Tray Separation Pad

Caution :

Do not touch the pad surface of the multi-purpose tray separation pad.

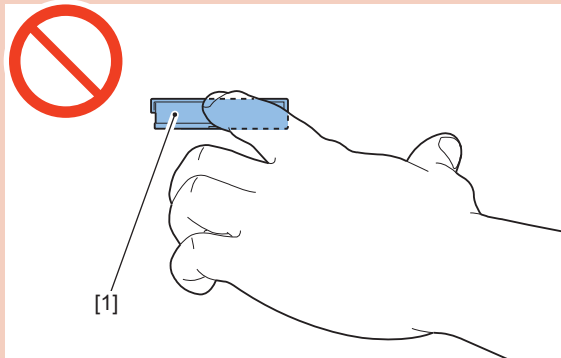

F-3-245

- 1) Open the manual pickup tray.
- 2) Remove the cover [1].
 - 2 claws [2]

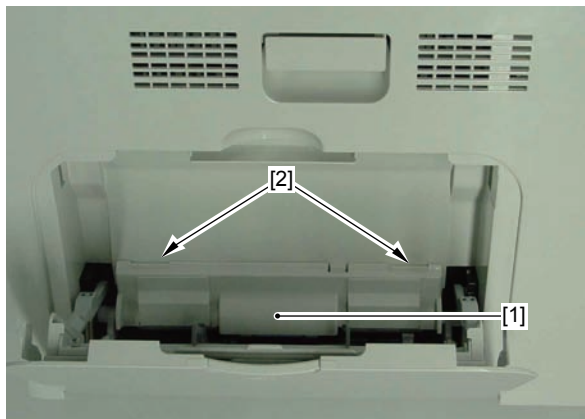

F-3-246

- 3) Insert the precision screwdriver into the clearance [2] of the multi-purpose tray separation pad [1]. Turn the precision screwdriver and remove the multi-purpose tray separation pad [1] from the multi-purpose tray separation pad holder [3].

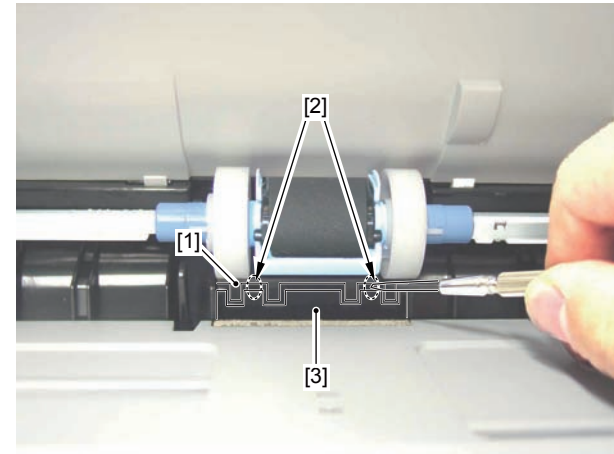

F-3-247

- 4) Remove the multi-purpose tray separation pad [1].

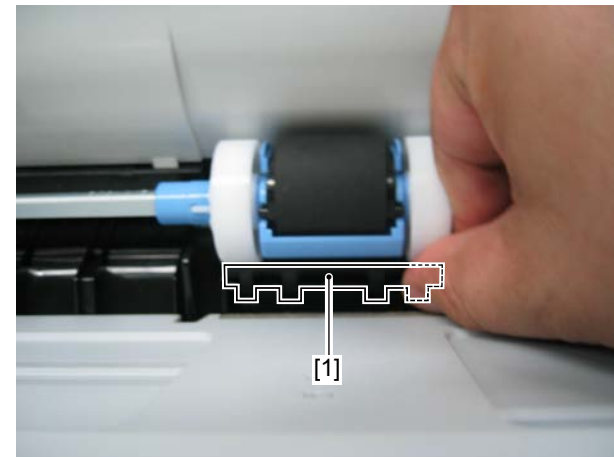

F-3-248

Points to note when installing the parts :

At installation, make sure to insert the protrusion [2] on the back of [1] into the hole of the multi-purpose tray separation pad holder [3].

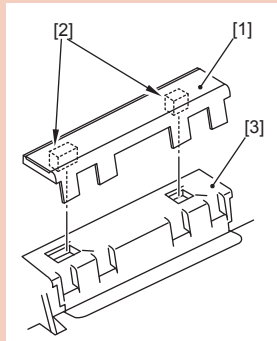

F-3-249

After installation, make sure that there is no clearance between the multi-purpose tray separation pad [1] and the multi-purpose tray separation pad holder [2].

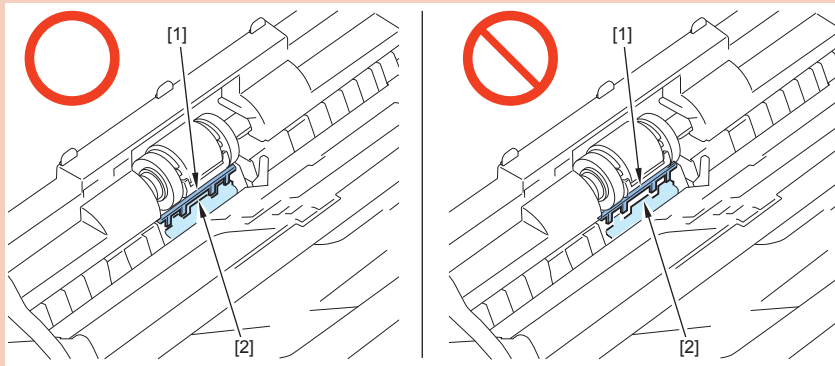

F-3-250

Removing the Controller Fan

Before Removing the Controller Fan

- 1) Remove the left cover. (Refer to page 3-11)
- 2) Remove the rear cover. (Refer to page 3-12)
- 3) Remove the ICB PCB. (Refer to page 3-101)

Removing the Controller Fan

- 1) Remove the Harness [2] from the edge saddle [1].
 - 6 connectors [3]
 - 1 wire saddle [4]

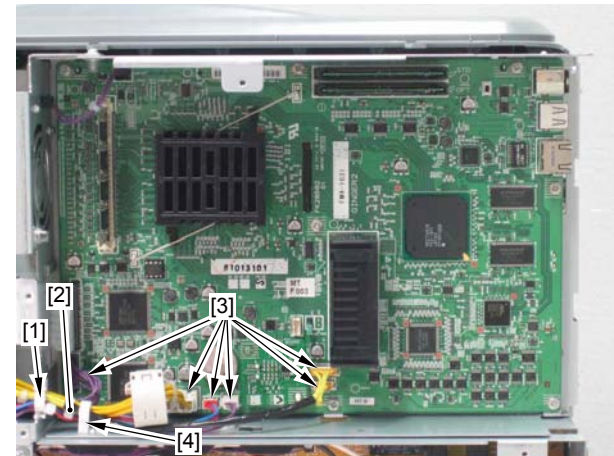

F-3-251

2) Remove the plate [1].

- 1 connector [2]
- 5 screws [3]

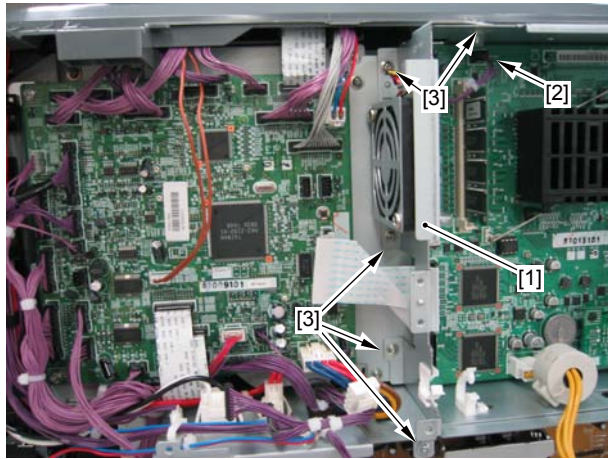

F-3-252

3) Remove the controller fan [1].

- 1 connector [2]
- 1 clamp [3]
- 2 screws [4]

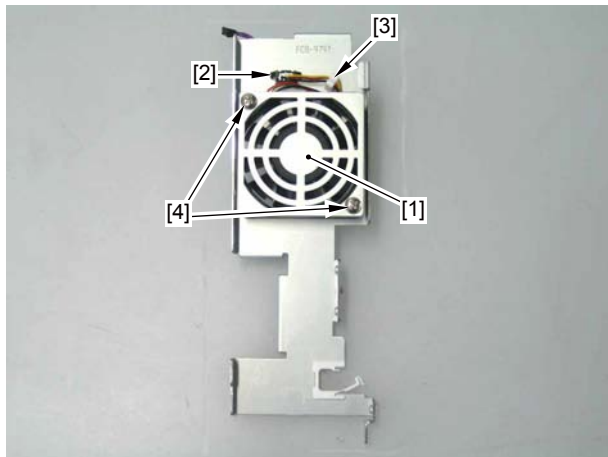

F-3-253

Points to note at installation :

When installing the controller fan, be careful of the installation direction.

- Make sure that the Fan Cable [1] is placed on the upper left.
- Make sure that the label side [2] is facing the plate [3].

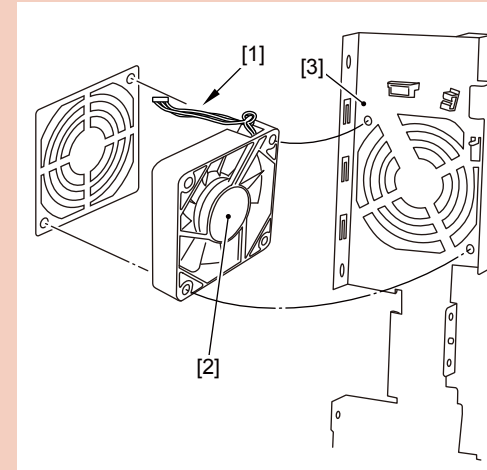

F-3-254

After installation, make sure that there is no clearance between the multi-purpose tray separation pad [1] and the multi-purpose tray separation pad holder [2].

PCB-related Issues

Removing the ICB PCB

Before Removing the ICB PCB

- 1) Remove the left cover. (Refer to page 3-11)
- 2) Remove the rear cover. (Refer to page 3-12)

Removing the ICB PCB

- 1) Remove the ICB PCB [1].
 - 7 connectors [1]
 - 1 clamp [3]
 - 2 screws [4]

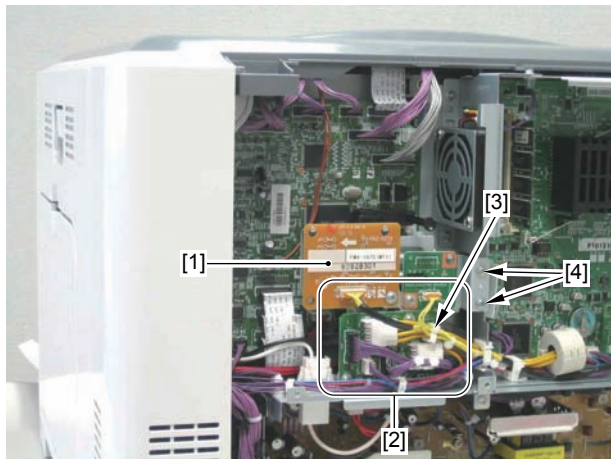

F-3-255

Removing the Main Controller PCB

Setting values and management data of this machine are memorized in the NVRAM (IC475) on the main controller PCB.

When replacing the main controller PCB, be sure to remove the NVRAM (IC475) from the old PCB and attach it to the new PCB to keep user mode settings.

Be sure to execute color displacement correction and calibration after the NVRAM is attached to the new PCB.

- 1) Turn on the host machine.
- 2) Execute "Utility > Calibration > Full calibration"

LBP7780C/LBP5480 (In case of machine without MEAP)

Because setting values and management data of this machine are stored in the flash memory of the Main Controller PCB, they need to be backed up before replacing the Main Controller PCB.

However, when the Main Controller PCB cannot operate normally because of flash memory failure or system error, the above data cannot be backed up.

Setting values of this machine: User mode setting values, service mode setting values

Management data of this machine: Page counter, device serial number

1 Backup and restoration of data using Expansion ROM for servicing and Sublog Board (or Sublog Board attached with the Expansion ROM hereafter)

Since setting values and management data can all be backed up by this method, all data can be restored by restoring the backup data after replacing the PCB.

2 Backup and restoration of data using USB memory

Since only setting values can be backed up by this method.

3 When data cannot be backed up before replacement due to Main Controller PCB error
Backing up data kept by the NVRAM of the DC Controller PCB to the Main Controller PCB

1 Backup and restoration of data using Sublog Board attached with Expansion ROM

For details, refer to the Service Manual > Chapter 5 Troubleshooting > Backup/Restoration by Expansion ROM for servicing and Sublog Board

1-1 Backing up data before replacing the PCB

Perform the following operation to back up data of the Main Controller PCB to the Sublog Board attached with the Expansion ROM.

- Turn OFF the power.
- Install the Expansion ROM for servicing to the Sublog Board.
- Install the Sublog Board attached with the Expansion ROM to the Main Controller PCB.

- Turn ON the power.
- When turning ON the power, "NVRAM export" is displayed on the Control Panel.
- Press the down arrow key.
- All data stored on the Main Controller PCB is backed up to the Sublog Board attached with the Expansion ROM.

1-2 Replacing the PCB

- Turn OFF the power.
- Remove the Sublog Board attached with the Expansion ROM from the Main Controller PCB.
- Replace the Main Controller PCB with a new one (service part).
- Install the Sublog Board attached with the Expansion ROM to the Main Controller PCB.

1-3 Restoring data after replacing the PCB

Perform the following operation to restore data backed up in the Sublog Board attached with the Expansion ROM to the Main Controller PCB.

- Turn ON the power.
- When the menu is displayed on the Control Panel upon turning ON the power, select "NVRAM import".
- Press the down arrow key.
- Data backed up in the Sublog Board attached with the Expansion ROM is restored to the Main Controller PCB.
- Turn OFF the power, and remove the Sublog Board attached with the Expansion ROM.

● 2 Backup and restoration of data using USB memory

2-1 Backing up data before replacing the PCB

Perform the following operation to back up data of the Main Controller PCB to the USB memory.

- Connect the USB memory to the host machine.
- Select Setup Menu>SERVICE MODE>FUNCTION GR.>USB-H>On.
- Back up data of the Main Controller PCB to the USB memory.
Select Setup Menu>SERVICE MODE>FUNCTION GR.>ECONF>EXPORT>ALL>Yes.
- Select Setup Menu>SERVICE MODE>FUNCTION GR.>USB-H>Off.
- Disconnect the USB memory from the host machine.

2-2 Replacing the PCB

- Turn OFF the power.
- Replace the Main Controller PCB with a new one (service part).

2-3 Performing operation after power-on.

Turn ON the power.

- "Initializing NVRAM" is displayed on the Control Panel for a few seconds.

- "Panel Language" is displayed.
- Here, select your own language.
- When the date setting screen appears, set the date and then press the OK key.
- When the time setting screen appears, set the time and then press the OK key.
- After the message "Setting Completed" appears, the message "Ready to print" appears, indicating the machine can be used normally.

2-4 Restoring data after replacing the PCB

Perform the following operation to restore data backed up in the USB memory to the Main Controller PCB.

- Connect the USB memory to the host machine.
- Select Setup Menu>SERVICE MODE>FUNCTION GR.>USB-H>On.
- Restore data backed up in the USB memory to the Main Controller PCB.
Select Setup Menu>SERVICE MODE>FUNCTION GR.>ECONF>IMPORT>Yes.
- Select Setup Menu>SERVICE MODE>FUNCTION GR.>USB-H>Off.
- Disconnect the USB memory from the host machine.

NOTE

When you execute Setup Menu>SERVICE MODE>FUNCTION GR.>ECONF>EXPORT>ALL>Yes upon backup of data by the USB memory, information kept by NVRAM on the DC Controller PCB is also backed up. Therefore, if "ALL" is selected, the operation to back up the information kept by NVRAM of the DC Controller PCB is not necessary.

● 3 When data cannot be backed up before replacement due to Main Controller PCB error

When the Main Controller PCB cannot operate normally, then backup of various data is not possible.

In this case, perform the following procedure to replace the PCB.

3-1 Replacing the PCB

- Turn OFF the power.
- Replace the Main Controller PCB with a new one (service part).

3-2 Performing operation after power-on.

- Turn ON the power.
- "Initializing NVRAM" is displayed on the Control Panel for a few seconds.
- "Panel Language" is displayed.
- Here, select your own language or English.
- When the date setting screen appears, set the date and then press the OK key.
- When the time setting screen appears, set the time and then press the OK key.
- After the message "Setting Completed" appears, the message "Ready to print" appears, indicating the machine can be used normally.

3-3 Backing up data kept by the NVRAM of the DC Controller PCB to the Main Controller PCB

- Initialize the DC Controller NVRAM backup area kept in the Main Controller PCB. Select Setup Menu>SERVICE MODE>FUNCTION GR.>CLEAR DCON.
- Turn OFF and then ON the power.
- By turning OFF and then ON the power, data kept by the DC Controller PCB NVRAM is backed up to the DC Controller NVRAM backup area in the Main Controller PCB.

● LBP7780C/LBP5480(In case of machine with MEAP)

Because setting values, management data of this machine and the MEAP application, etc. are stored in the flash memory of the Main Controller PCB, they need to be backed up before replacing the Main Controller PCB. However, when the Main Controller PCB cannot operate normally because of flash memory failure or system error, the above data cannot be backed up.

Also, restoration of the backup data and reinstallation of the MEAP application is necessary after replacing the Main Controller PCB.

Setting values of this machine: User mode setting values, service mode setting values

Management data of this machine: Page counter, device serial number

1 Backup and restoration of data using Expansion ROM for servicing and Sublog Board (or Sublog Board attached with the Expansion ROM hereafter)

While setting values and management data can be backed by this method, the MEAP application cannot be backed up by the method. Therefore, reinstallation of the MEAP application is necessary after replacing the PCB and then restoring the backup data.

2 Backup and restoration of data using USB memory

Only setting values can be backed up by this method. Therefore, reinstallation of the MEAP application is necessary after replacing the PCB and then restoring the backup data.

3 When data cannot be backed up before replacement due to Main Controller PCB error
Reinstallation of the MEAP application is necessary after replacing the PCB.

● 1 Backup and restoration of data using Sublog Board attached with Expansion ROM and copy of data using laptop PC for servicing

1-1 Actions before replacing the PCB

1-1-1 Preparation required for reinstalling the MEAP application

For details on preparation required for reinstalling the MEAP application, refer to the Service Manual > Chapter 2 Technical Description > MEAP > Maintenance > Procedure for reinstalling MEAP applications after replacing the PCB.

1-1-2 Backing up to Sublog Board attached with the Expansion ROM

For details on backup to Sublog Board attached with the Expansion ROM, refer to the Service Manual > Chapter 5 Troubleshooting > Backup/Restoration by Expansion ROM for servicing and Sublog Board

- Turn OFF the power.
- Install the Expansion ROM for servicing to the Sublog Board.
- Install the Sublog Board attached with the Expansion ROM to the Main Controller PCB.
- Turn ON the power.
- When turning ON the power, "NVRAM export" is displayed on the Control Panel.
- Press the down arrow key.
- The data of the Main Controller PCB is backed up to the Sublog Board attached with the Expansion ROM.

1-2 Replacing the PCB

- Turn OFF the power.
- Replace the Main Controller PCB with a new one (service part).
- Install the Sublog Board attached with the Expansion ROM to the Main Controller PCB.

1-3 Restoring data after replacing the PCB

Perform the following operation to restore data backed up in the Sublog Board attached with the Expansion ROM to the Main Controller PCB.

- Turn ON the power.
- When the menu is displayed on the Control Panel upon turning ON the power, select "NVRAM import".
- Press the down arrow key.
- Data backed up in the Sublog Board attached with the Expansion ROM is restored to the Main Controller PCB.
- Turn OFF the power, and remove the Sublog Board attached with the Expansion ROM.

1-4 Reinstalling the MEAP application and importing user information

For details on preparation required for reinstalling the MEAP application and importing user information, refer to the Service Manual > Chapter 2 Technical Description > MEAP > Maintenance > Procedure for reinstalling MEAP applications after replacing the PCB.

● 2 Backup and restoration of data using USB memory and copy of data using laptop PC for servicing

2-1 Actions before replacing the PCB

2-1-1 Preparation required for reinstalling the MEAP application

For details on preparation required for reinstalling the MEAP application, refer to the Service Manual > Chapter 2 Technical Description > MEAP > Maintenance > Procedure for reinstalling MEAP applications after replacing the PCB.

2-1-2 Backup to USB memory

- Connect the USB memory to the host machine.
- Select Setup Menu>SERVICE MODE>FUNCTION GR.>USB-H>On.
- Back up data of the Main Controller PCB to the USB memory.
Select Setup Menu>SERVICE MODE>FUNCTION GR.>ECONF>EXPORT>ALL>Yes.
- Select Setup Menu>SERVICE MODE>FUNCTION GR.>USB-H>Off.
- Disconnect the USB memory from the host machine.

2-2 Replacing the PCB and turning ON the power

- Turn OFF the power.
- Replace the Main Controller PCB with a new one (service part).
- Turn ON the power.
- The equipment is started and can be used normally.

2-3 Restoring data after replacing the PCB

Perform the following operation to restore data backed up in the USB memory to the Main Controller PCB.

- Connect the USB memory to the host machine.
- Select Setup Menu>SERVICE MODE>FUNCTION GR.>USB-H>On.
- Restore data backed up in the USB memory to the Main Controller PCB.
Select Setup Menu>SERVICE MODE>FUNCTION GR.>ECONF>IMPORT>Yes.
- Select Setup Menu>SERVICE MODE>FUNCTION GR.>USB-H>Off.
- Disconnect the USB memory from the host machine.

NOTE

When you execute Setup Menu>SERVICE MODE>FUNCTION GR.>ECONF>EXPORT>ALL>Yes upon backup of data by the USB memory, information kept by NVRAM on the DC Controller PCB is also backed up. Therefore, if "ALL" is selected, the operation to back up the information kept by NVRAM of the DC Controller PCB is not necessary.

2-4 Reinstalling the MEAP application and importing user information

For details on preparation required for reinstalling the MEAP application and importing user information, refer to the Service Manual > Chapter 2 Technical Description > MEAP > Maintenance > Procedure for reinstalling MEAP applications after replacing the PCB.

3 When data backup from the Main Controller PCB is not possible

When the Main Controller PCB cannot operate normally, then backup of various data is not possible.

In this case, perform the following procedure to replace the PCB.

3-1 Replacing the PCB and turning ON the power

- Turn OFF the power.
- Replace the Main Controller PCB with a new one (service part).

- Turn ON the power.
- The equipment is started and can be used normally.

3-2 Backing up data kept by the NVRAM of the DC Controller PCB to the Main Controller PCB

- Perform the following operation to initialize the DC Controller NVRAM backup area of the Main Controller PCB.
Select Setup Menu>SERVICE MODE>FUNCTION GR.>CLEAR DCON.
- Turn OFF and then ON the power.
- By turning OFF and then ON the power, information kept by the DC Controller PCB NVRAM is backed up to the DC Controller NVRAM backup area in the Main Controller PCB.

3-3 Reinstalling the MEAP application

For details on reinstalling the MEAP application, refer to the Service Manual > Chapter 2 Technical Description > MEAP > Maintenance > Procedure for reinstalling MEAP applications after replacing the PCB.

● LBP7750C/LBP5460

■ Before Removing the Main Controller PCB

- 1) Remove the left cover.(Refer to page 3-11)
- 2) Remove the rear cover.(Refer to page 3-12)

■ Removing the Main Controller PCB

- 1) Remove the 6 screws [1], remove the Plate [2].

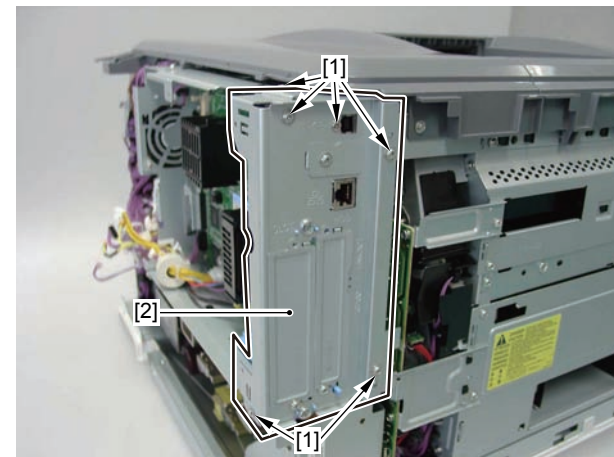

F-3-256

2) Remove the harness [1].

- 7 connectors [2]
- 1 flat cable [3]
- 1 wire saddle [4]
- 1 edge saddle [5]

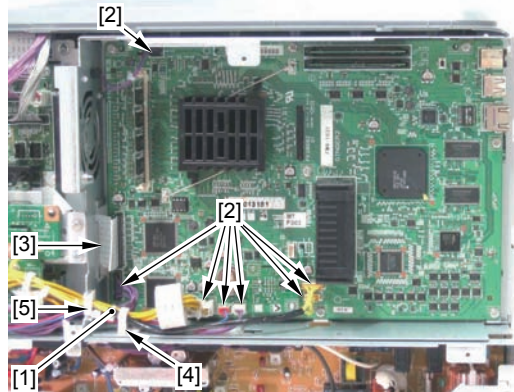

F-3-257

3) Remove the main controller [1].

- 8 screws [2]

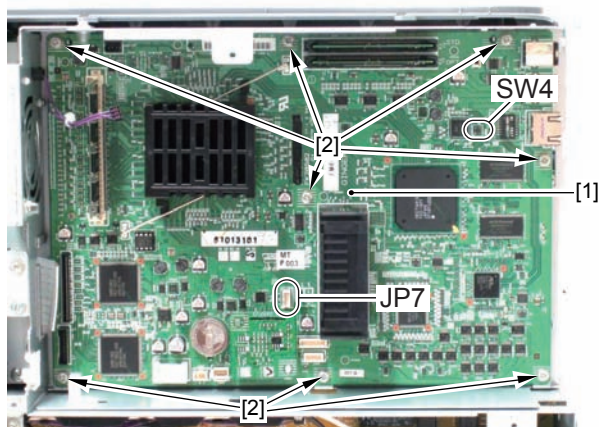

F-3-258

MEMO :

SW4(push SW) is not used for service use.

The jumper connector is installed on JP7 as follows.



F-3-259

Before Removing the Main Controller PCB(LBP7780C/LBP5480)

- 1) Remove the left cover.(Refer to page 3-11)
- 2) Remove the right rear cover.(Refer to page 3-13)
- 3) Remove the rear cover(Refer to page 3-12)

Removing the Main Controller PCB(LBP7780C/LBP5480)

- 1) Remove the Plate [1].
 - 4 screws [2]
 - 1 flat cable[3]

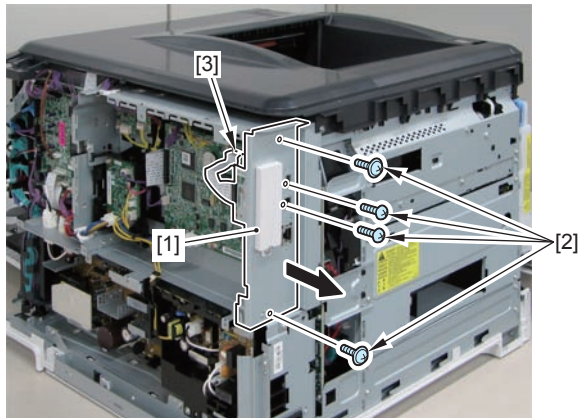

F-3-260

- 2) Remove the 7 connectors[1] and flat cable[2]

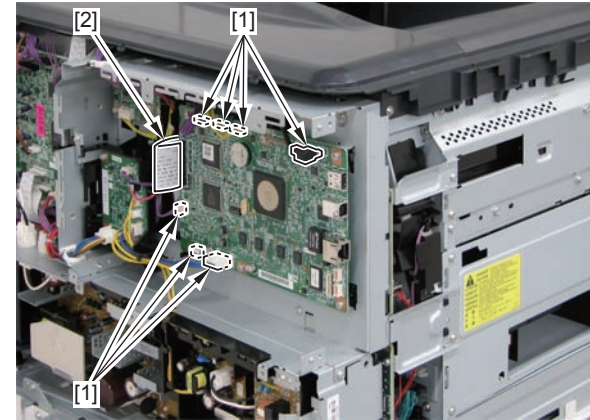

F-3-261

- 3) Remove the main controller PCB[1].

- 6 screws [2]

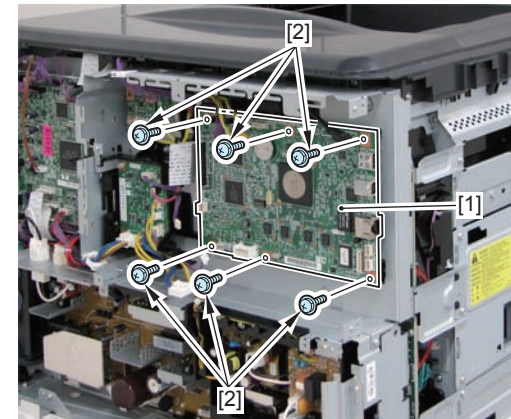

F-3-262

Removing the RELAY PCB(LBP7780C/LBP5480)

Before Removing the RELAY PCB

- 1) Remove the left cover.(Refer to page 3-11)
- 2) Remove the right rear cover.(Refer to page 3-13)
- 3) Remove the rear cover(Refer to page 3-12)

Removing the RELAY PCB

- 1) Remove the RELAY PCB [1].
 - 4 connectors [2]
 - 1 claw [3]
 - 1 screw [4]

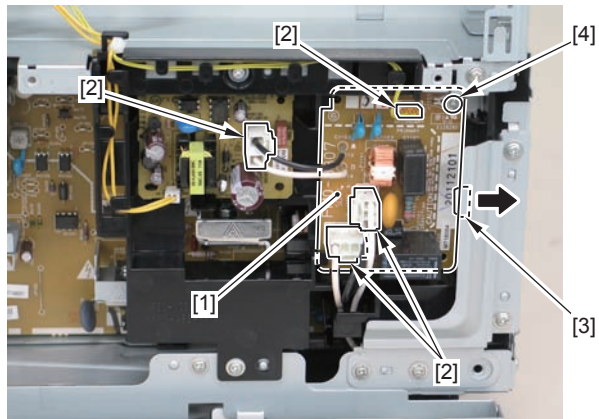

F-3-263

Removing the ALL NIGHT PCB(LBP7780C/LBP5480)

Before Removing the ALL NIGHT PCB

- 1) Remove the left cover.(Refer to page 3-11)
- 2) Remove the right rear cover.(Refer to page 3-13)
- 3) Remove the rear cover(Refer to page 3-12)

Removing the ALL NIGHT PCB

- 1) Remove the ALL NIGHT PCB [1].
 - 2 connectors [2]
 - 1 claw [3]

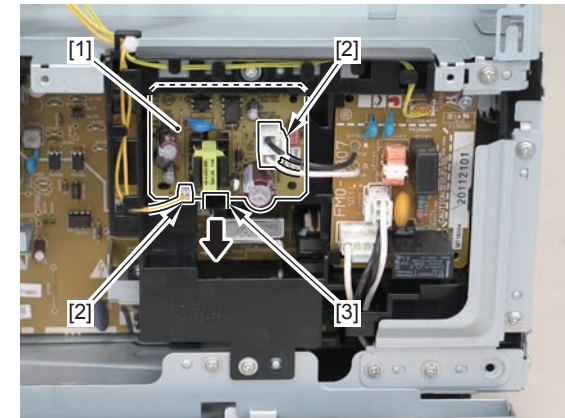

F-3-264

Removing the SLEEP IF PCB(LBP7780C/LBP5480)

Before Removing the SLEEP IF PCB

- 1) Remove the left cover.(Refer to page 3-11)
- 2) Remove the right rear cover.(Refer to page 3-13)
- 3) Remove the rear cover(Refer to page 3-12)

Removing the SLEEP IF PCB

- 1) Remove the 7 connectors[1] and harness[2] from the cable guide[3].

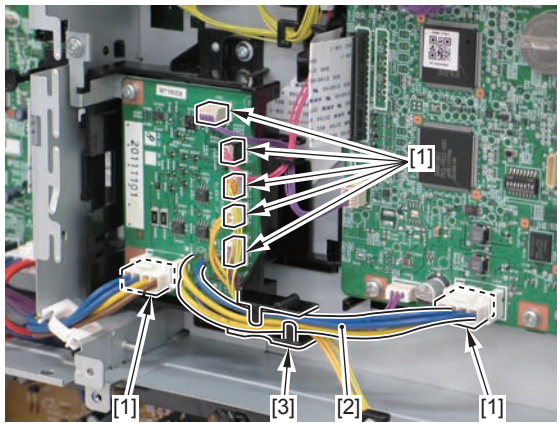

F-3-265

- 2) Remove the SLEEP IF PCB[1]
 - 1 screw [2]
 - 1 claw [3]

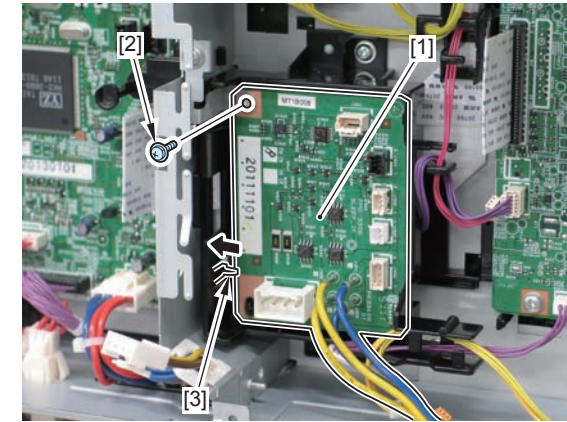

F-3-266

Removing the SD CARD PCB(LBP7780C/LBP5480)

Before Removing the SD CARD PCB

- 1) Remove the left cover.(Refer to page 3-11)
- 2) Remove the right rear cover.(Refer to page 3-13)
- 3) Remove the rear cover(Refer to page 3-12)

Removing the SD CARD PCB

- 1) Remove the flat cable[1] and SD CARD cover[2]
 - 1 screw[3]
 - 1 hook[4]

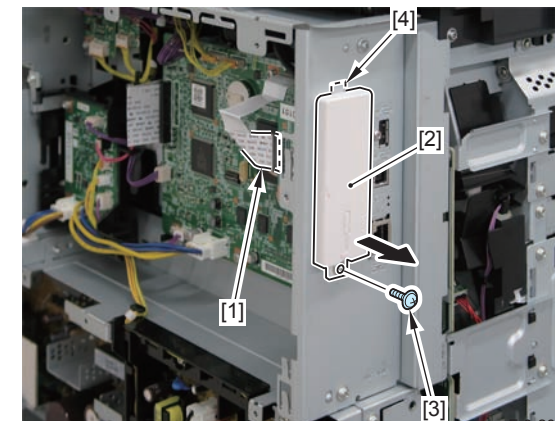

F-3-267

2) Remove the SD CARD PCB bracket and remove the SD CARD PCB[1].

- 2 screws[2]
- 1 hook[3]

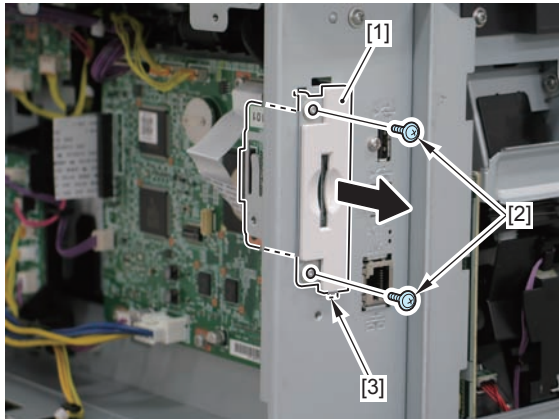

F-3-268

Removing the Low Voltage Power Unit

Before Removing the Low Voltage Power Unit

- 1) Remove the left cover. (Refer to page 3-11)
- 2) Remove the rear cover. (Refer to page 3-12)
- 3) Remove the right rear cover. (Refer to page 3-13)
- 4) Remove the ICB PCB. (Refer to page 3-101)
- 5) Remove the main controller PCB. (Refer to page 3-101)

Removing the Low Voltage Power Unit

- 1) Remove the 6 connectors [1].

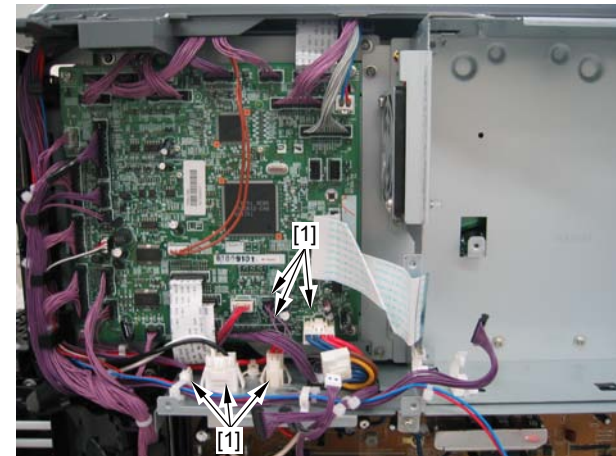

F-3-269

2) Remove the cable from the 2 wire saddles [1].

3) Remove the reuse band [2].

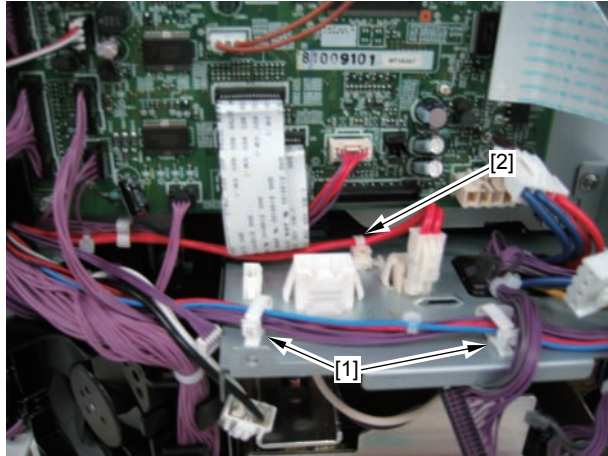

F-3-270

4) Remove the handle [1].

• 3 screws [2]

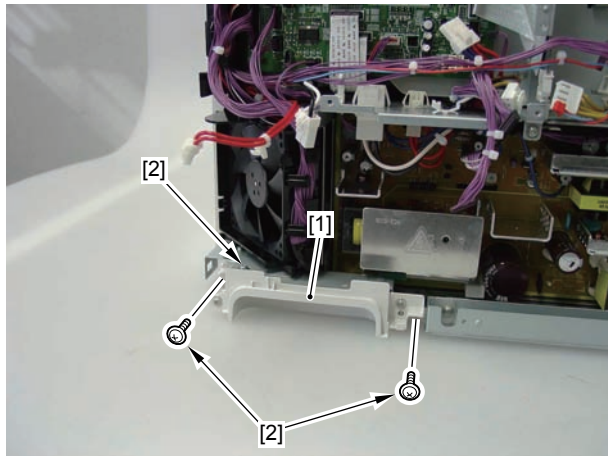

F-3-271

5) Remove the plate [1].

• 2 screws [2]

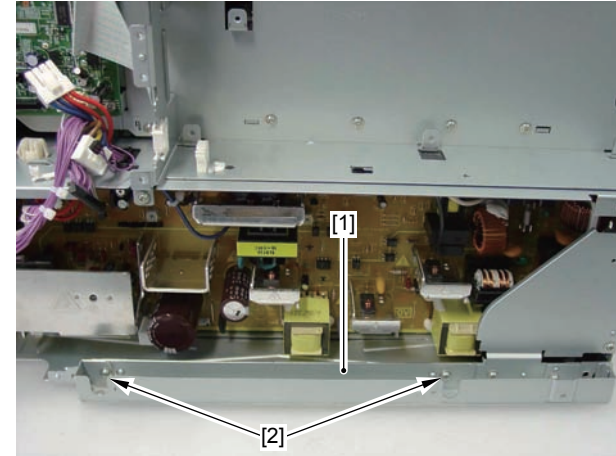

F-3-272

6) Remove the plate [1].

• 3 screws [2]

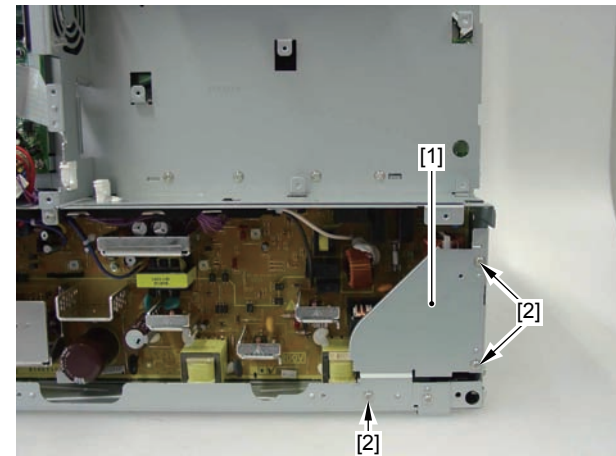

F-3-273

7) Remove the controller mount [1].

- 8 screws [2]

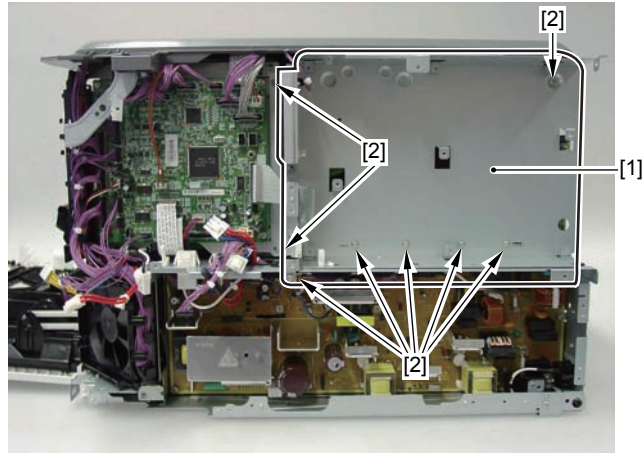

F-3-274

8) Remove the low voltage power unit [1].

- 4 screws [2]

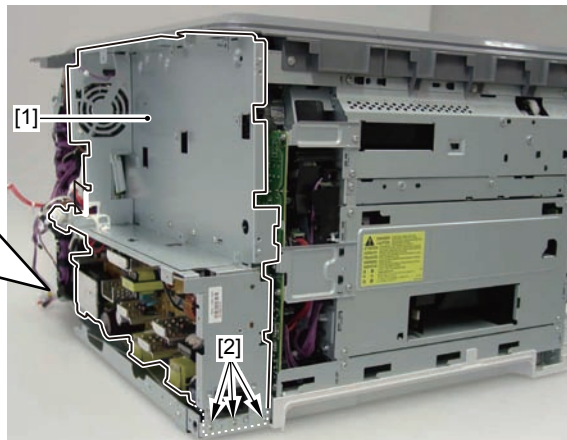
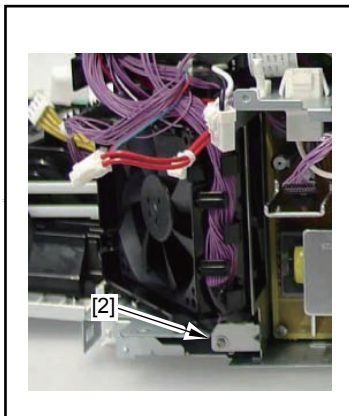

F-3-275

Caution :

When removing or installing the low voltage power unit, be careful not to damage the lower high voltage power supply PCD and the upper high voltage power supply PCD.

Removing the Low Voltage Power Unit(LBP7780C/LBP5480)

Before Removing the Low Voltage Power Unit

- 1) Remove the left cover.(Refer to page 3-11)
- 2) Remove the right rear cover.(Refer to page 3-13)
- 3) Remove the rear cover(Refer to page 3-12)

Removing the Low Voltage Power Unit

- 1) Remove the plate[1].
- 4 screws[2]

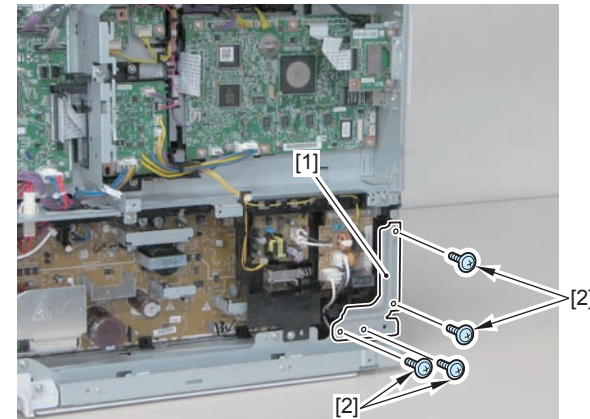

F-3-276

2) Remove the RELAY/ALL NIGHT PCB[1]

- 4 connectors[2]
- 3 screws[3]
- 2 claws[4]

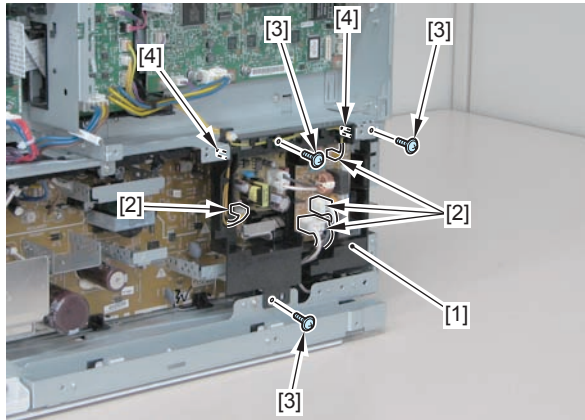

F-3-277

3) Remove the handle[1]

- 2 screws[2]

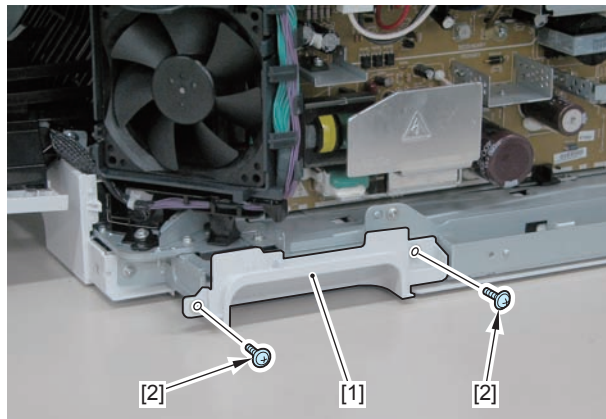

F-3-278

4) Remove the plate[1]

- 2 screws[2]
- 4 hooks[3]

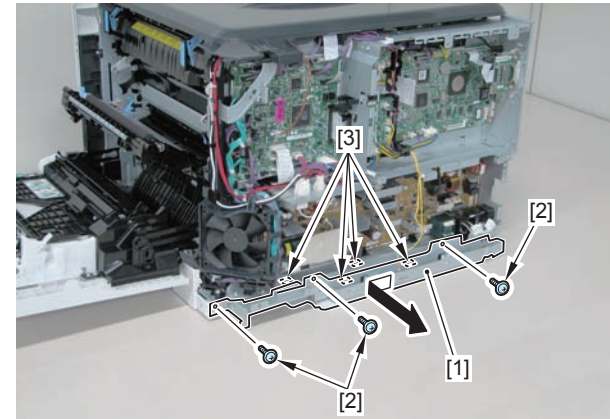

F-3-279

5) Remove the main controller PCB[1]

- 7 screws[2]
- 1 flat cable[3]
- 3 connectors[4]
- 1 USB cable[5]
- 2 edge saddle[6]

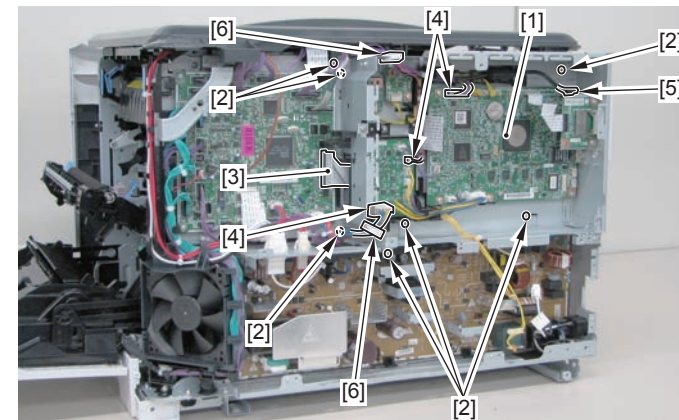

F-3-280

6) Remove the Low Voltage Power Unit [1].

- 3 screws [2]
- 4 connectors [3]
- 1 reuse band [4].

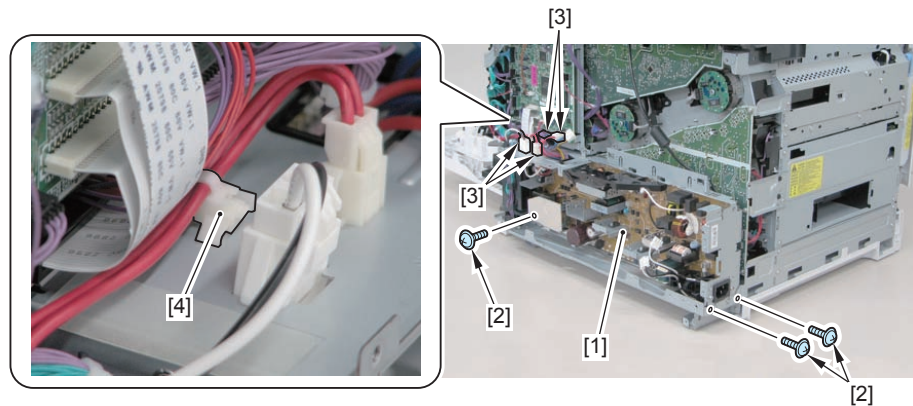

F-3-281

Caution :

When removing or installing the low voltage power unit, be careful not to damage the lower high voltage power supply PCD and the upper high voltage power supply PCD.

Removing the DC Controller PCB

Information of the NVRAM mounted on the DC controller PCB is saved in the NVRAM on the main controller PCB.

The backup data can be restored to the NVRAM on the DC controller PCB by executing the printer restore setting via the service mode.

When replacing the DC controller PCB, be sure to execute backup data restore, color displacement correction, and calibration via the service mode.

- 1) Execute "Service mode > FUNCTION GR. > RESTORE DCON
- 2) Turn off the host machine.
- 3) Execute "Utility > Calibration > Full calibration

Before Removing the DC Controller PCB

- 1) Remove the left cover. (Refer to page 3-11)
- 2) Remove the rear cover. (Refer to page 3-12)
- 3) Remove the right rear cover. (Refer to page 3-13)
- 4) Remove the ICB PCB. (Refer to page 3-101)

Removing the DC Controller PCB

- 1) Remove the plate [1].
 - 1 screw [2]

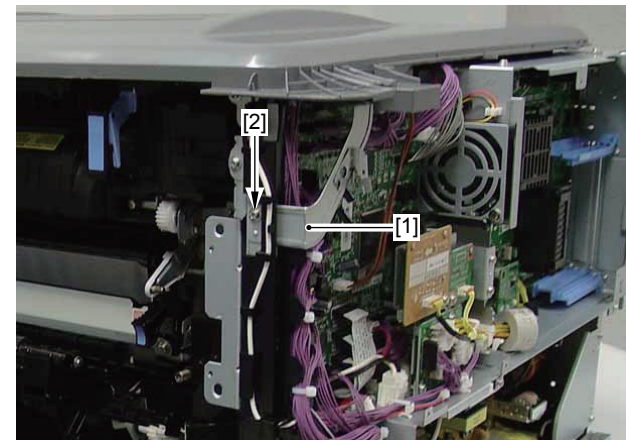

F-3-282

2) Remove all the connectors on the DC controller PCB.

- 23 connectors
- 5 flat cables

3) Remove the DC controller PCB [1].

- 4 screws [2]

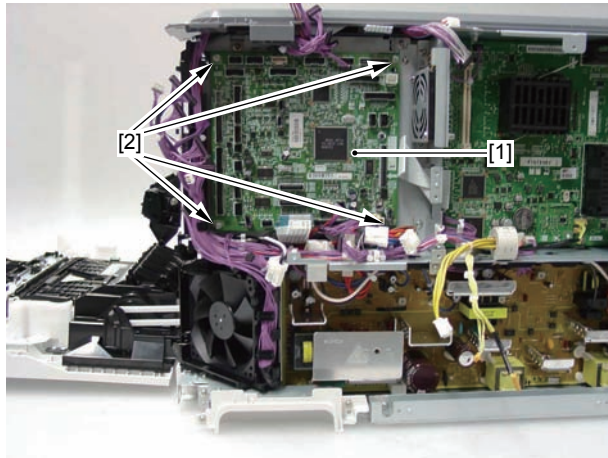

F-3-283

Removing the DC controller PCB(LBP7780C/LBP5480)

NVRAM information on the DC Controller PCB is stored in the NVRAM on the Main Controller PCB as a backup.

The data that has been backed up can be restored to the NVRAM on the DC Controller PCB in the service mode.

- 1) Execute the following: service mode > FUNCTION GR.>RESTORE DCON.
- 2) Turn OFF and then ON the power of the host machine.

Before Removing the DC Controller PCB

- 1) Remove the left cover.(Refer to page 3-11)
- 2) Remove the rear cover.(Refer to page 3-12)
- 3) Remove the right rear cover.(Refer to page 3-13)

Removing the DC Controller PCB

1) Remove the plate [1].

- 1 screw [2]

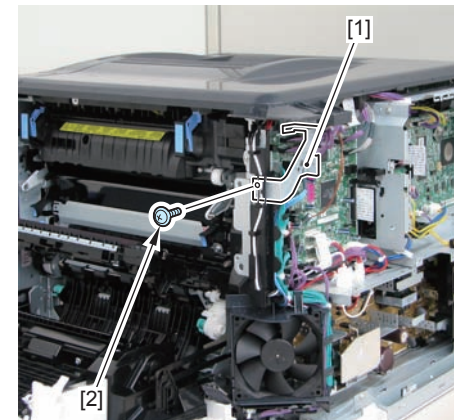

F-3-284

2) Remove all the connectors on the DC controller PCB.

- 25 connectors
- 5 flat cables

3) Remove the switch for test print [1].

- 2 screws [2]

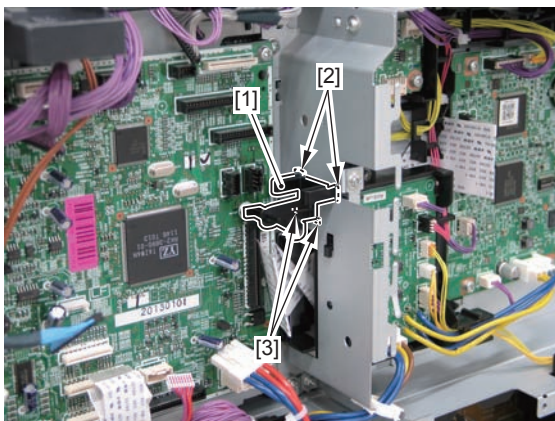

4) Remove the DC controller PCB [1].

- 4 screws [2]

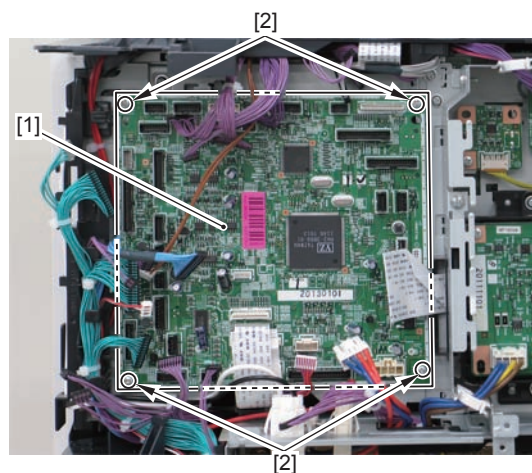

F-3-285

Removing the Lower High Voltage Power Supply PCB

Before Removing the Lower High Voltage Power Supply PCB

- 1) Remove the left cover. (Refer to page 3-11)
- 2) Remove the rear cover. (Refer to page 3-12)
- 3) Remove the right rear cover. (Refer to page 3-13)
- 4) Remove the ICB PCB. (Refer to page 3-101)
- 5) Remove the main controller PCB. (Refer to page 3-101)
- 6) Remove the low voltage power unit. (Refer to page 3-109)

Removing the Lower High Voltage Power Supply PCB

- 1) Remove the 2 connectors [1] and the 3 screws [2].

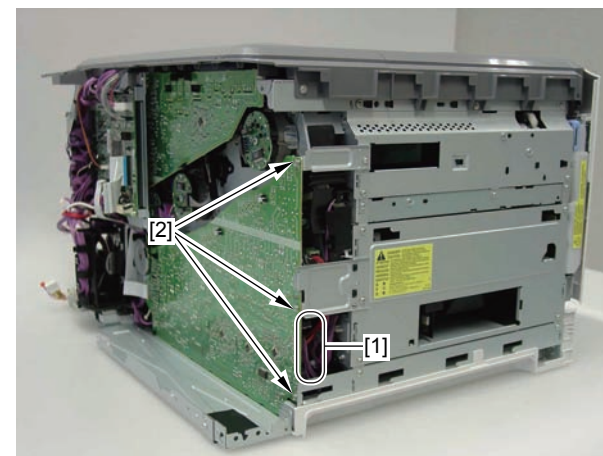

F-3-286

2) Remove the connector [1] and the flat cable.[2]

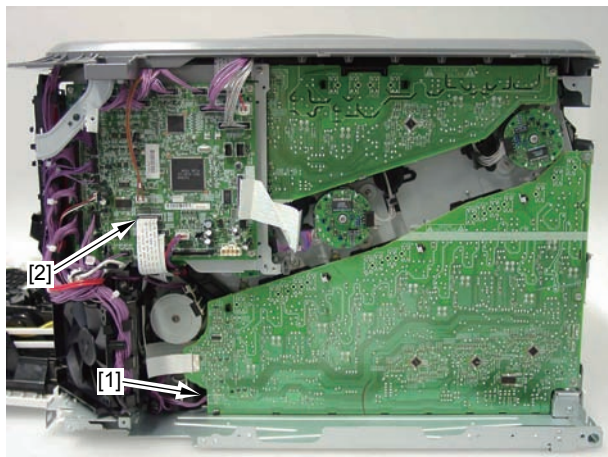

F-3-287

3) Remove the flat cable [1] from the guide.[2]

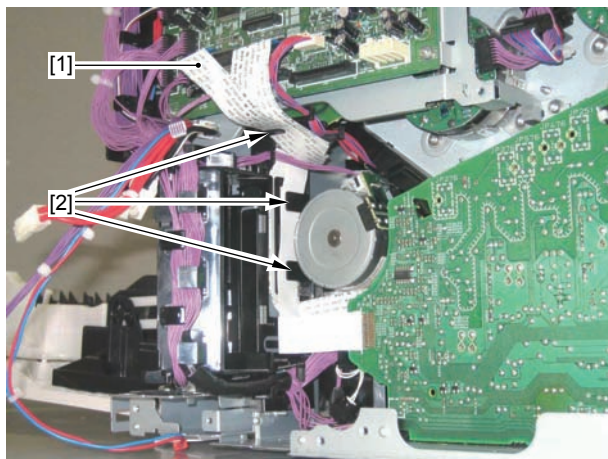

F-3-288

4) Remove the lower high voltage power supply PCB.[1]

- 3 holder caps [2]
- 5 claws [3]

MEMO :

Pull it out while opening holder cap [2].

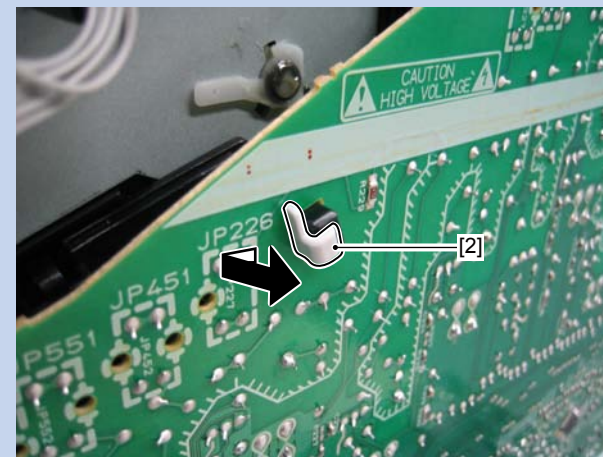

F-3-289

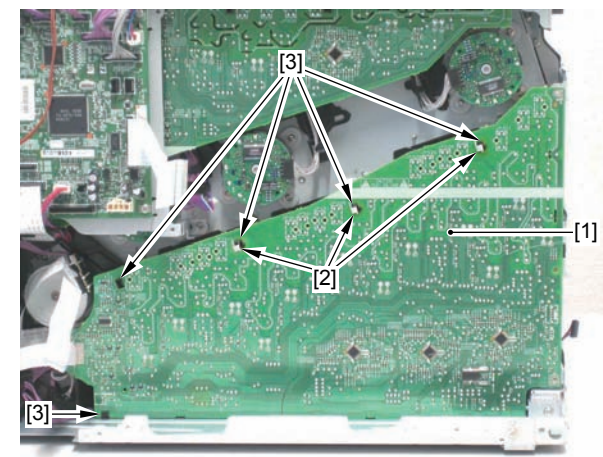

F-3-290

Note at installation :

When installing the lower high voltage power supply PCB [1] to the host machine, make sure that the contact spring [3] contacts with outline of holes from the 18 round holes [2].

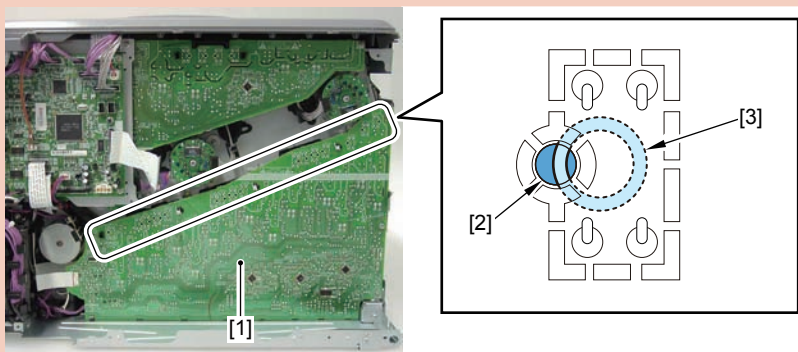

F-3-291

Removing the Lower High Voltage Power Supply PCB(LBP7780C/LBP5480)

Before Removing the Lower High Voltage Power Supply PCB

- 1) Remove the left cover.(Refer to page 3-11)
- 2) Remove the right rear cover.(Refer to page 3-13)
- 3) Remove the rear cover.(Refer to page 3-12)
- 4) Remove the main controller PCB.(Refer to page 3-106)
- 5) Remove the low voltage power unit.(Refer to page 3-109)

Removing the Lower High Voltage Power Supply PCB

- 1) Remove the 2 connectors [1] and the 3 screws [2].

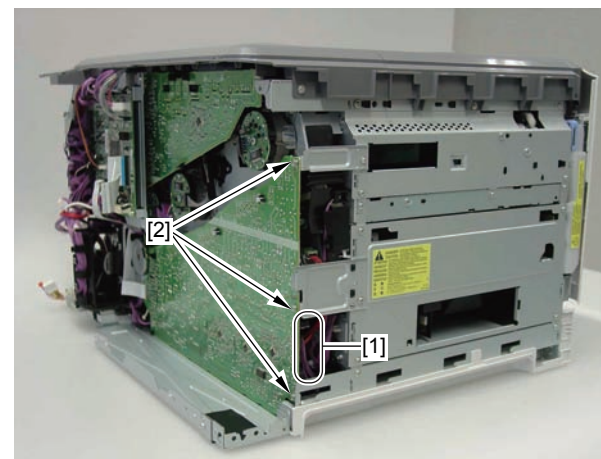

F-3-292

2) Remove the connector [1] and the flat cable.[2]

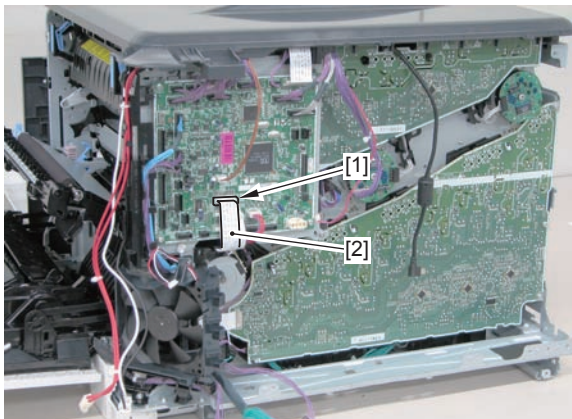

F-3-293

3) Remove the flat cable [1] from the guide.[2]

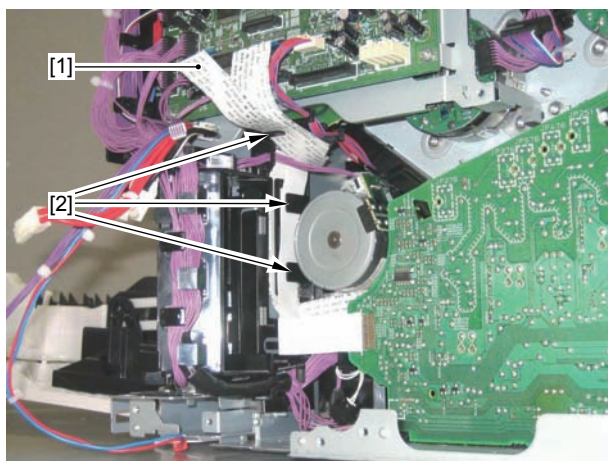

F-3-294

4) Remove the lower high voltage power supply PCB.[1]

- 3 holder caps [2]
- 5 claws [3]

MEMO :

Pull it out while opening holder cap [2].

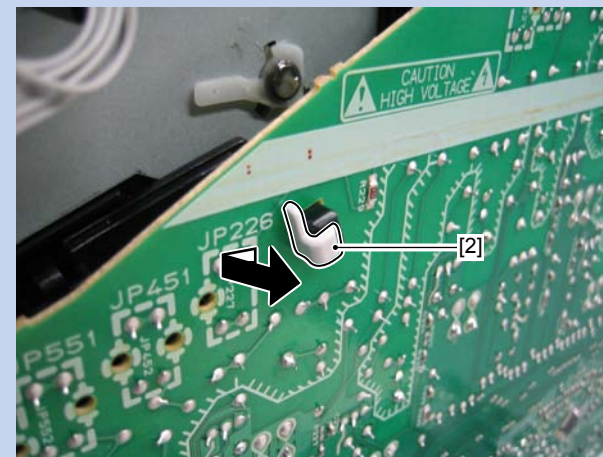

F-3-295

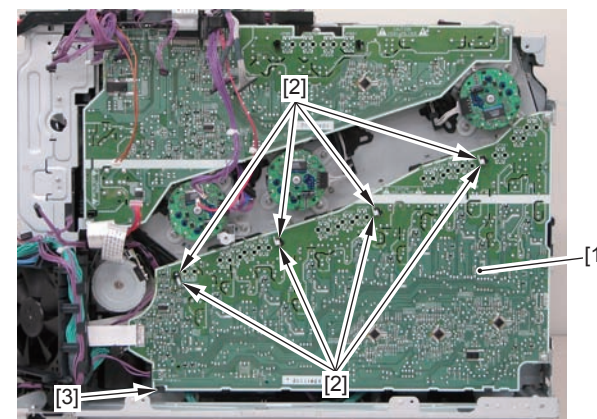

F-3-296

Note at installation :

When installing the lower high voltage power supply PCB [1] to the host machine, make sure that the contact spring [3] contacts with outline of holes from the 18 round holes [2].

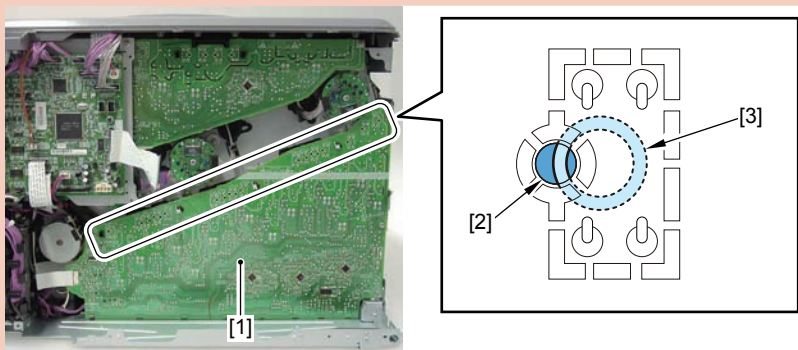

F-3-297

Removing the Upper High Voltage Power Supply PCB

Before Removing the Upper High Voltage Power Supply PCB

- 1) Remove the left cover.(Refer to page 3-11)
- 2) Remove the rear cover.(Refer to page 3-12)
- 3) Remove the right rear cover.(Refer to page 3-13)
- 4) Remove the ICB PCB.(Refer to page 3-101)
- 5) Remove the main controller PCB.(Refer to page 3-101)
- 6) Remove the low voltage power unit.(Refer to page 3-109)
- 7) Remove the control panel unit right cover.(Refer to page 3-14)
- 8) Remove the control panel unit left cover.(Refer to page 3-15)
- 9) Remove the upper front cover unit.(Refer to page 3-16)
- 10) Remove the upper rear cover.(Refer to page 3-21)

Removing the Upper High Voltage Power Supply PCB

- 1) Remove all the connectors on the DC controller PCB.
 - 23 connectors
 - 5 flat cables
- 2) Remove the DC controller PCB [1].
 - 4 screws [2]

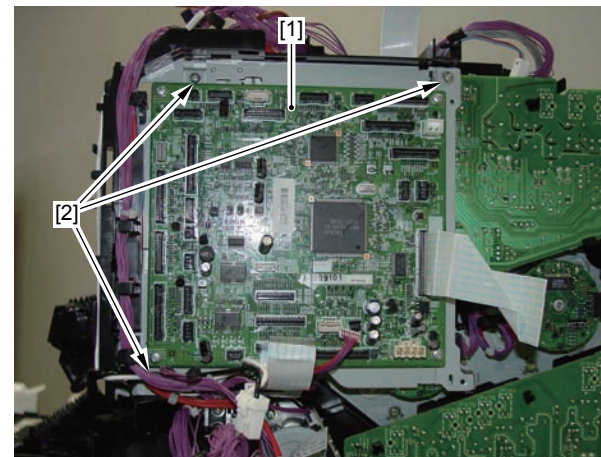

F-3-298

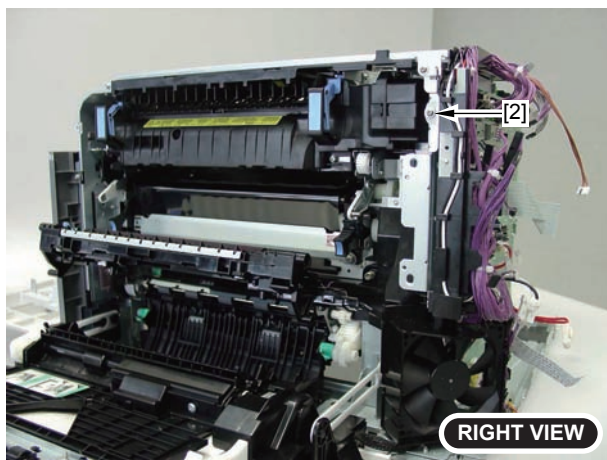

F-3-299

Caution :

Before removing the PCB, be sure to remove the cable from the harness guide.

3) Remove the 2 connectors [1].

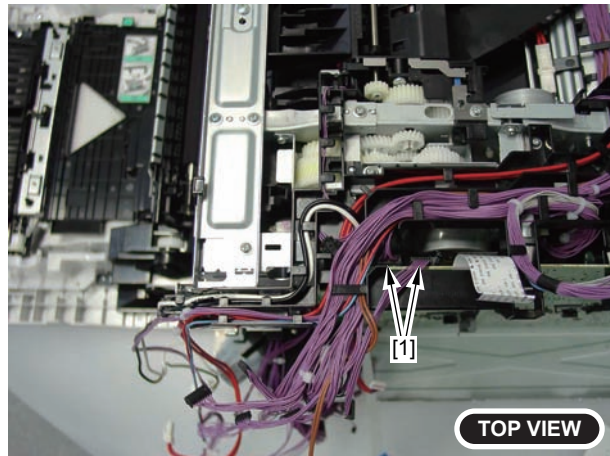

F-3-300

4) Remove the upper high voltage power supply PCB [1].

- 3 screws [2]
- 3 claws [3]

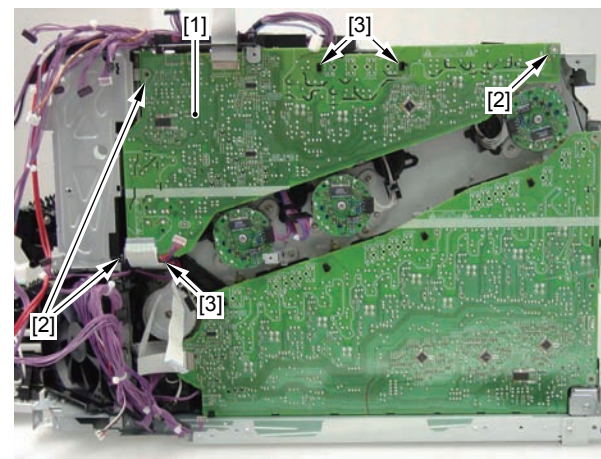

F-3-301

Caution :

When installing the upper high voltage power supply PCB to the host machine, make sure that the contact spring [3] contacts with the outline of holes from the 4 round holes [2].

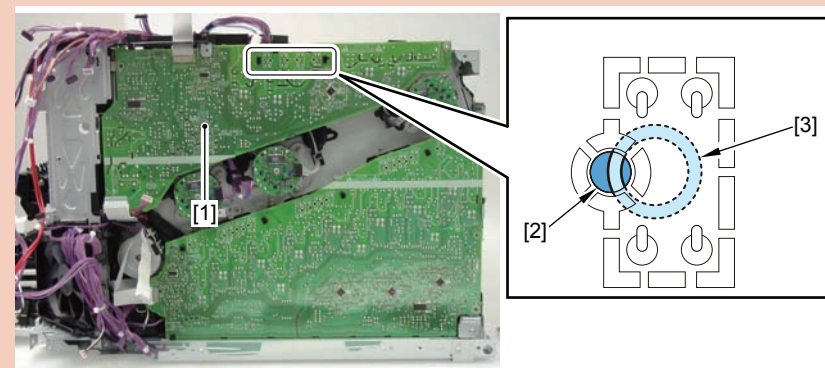

F-3-302

Removing the Upper High Voltage Power Supply PCB(LBP7780C/LBP5480)

Before Removing the Upper High Voltage Power Supply PCB

- 1) Remove the left cover.(Refer to page 3-11)
- 2) Remove the right rear cover.(Refer to page 3-13)
- 3) Remove the rear cover.(Refer to page 3-12)
- 4) Remove the RELAY/ALL NIGHT PCB unit.(Refer to page 3-107)
- 5) Remove the main controller PCB.(Refer to page 3-106)
- 6) Remove the low voltage power unit.(Refer to page 3-111)
- 7) Remove the control panel unit right cover.(Refer to page 3-14)
- 8) Remove the control panel unit left cover.(Refer to page 3-15)
- 9) Remove the upper front cover unit.(Refer to page 3-16)
- 10) Remove the upper rear cover.(Refer to page 3-21)

Removing the Upper High Voltage Power Supply PCB

- 1) Remove the plate[1]
 - 1 screw[2]

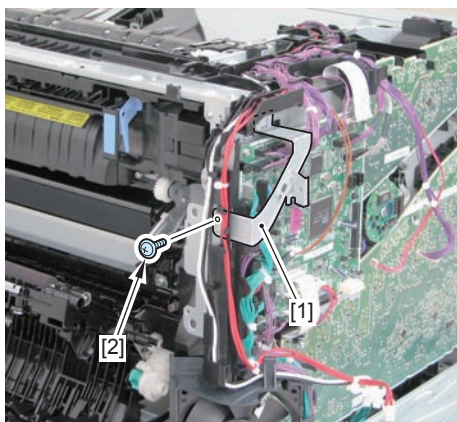

F-3-303

- 2) Remove all the controllers.
 - 23 connectors
 - 4 flat cables
 - 1 wire saddle

- 3) Remove the DC controller PCB[1].

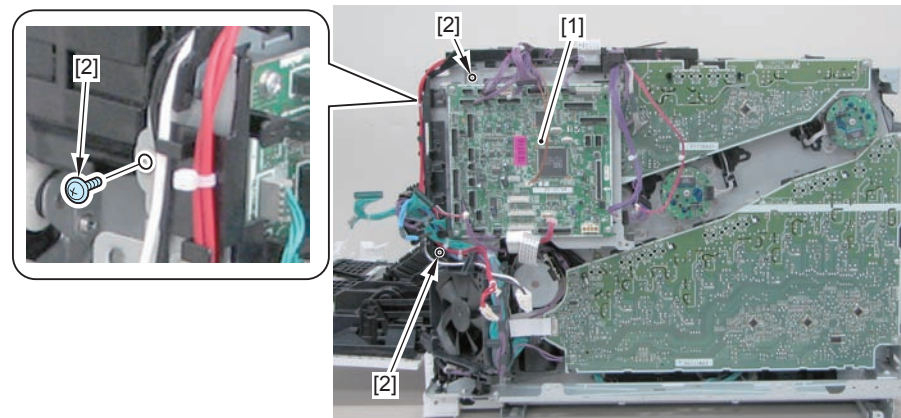

F-3-304

- 3) Remove the 1 connector[1].

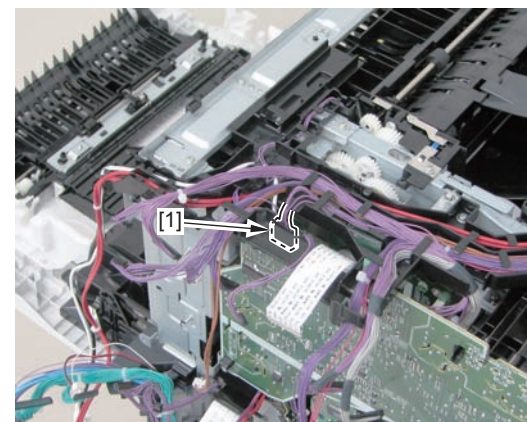

F-3-305

4) Remove the upper high voltage power supply PCB [1].

- 3 screws [2]
- 4 claws [3]

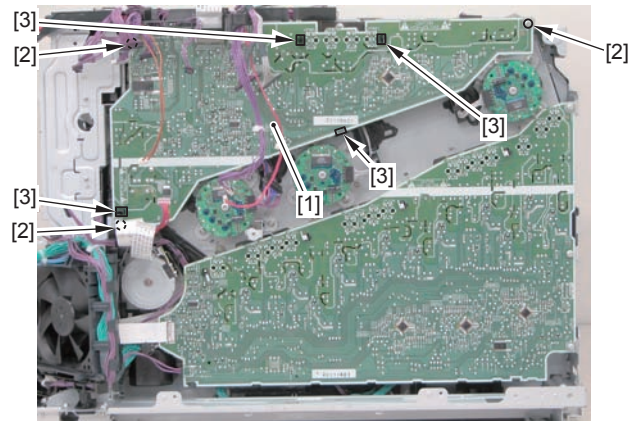

F-3-306

Caution :

When installing the upper high voltage power supply PCB to the host machine, make sure that the contact spring [3] contacts with the outline of holes from the 6 round holes [2].

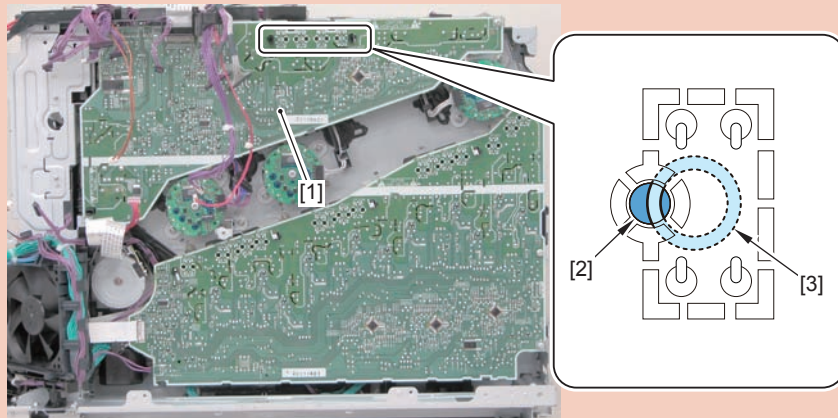

F-3-307

Removing the Environment Sensor

Before Removing the Environment Sensor

- 1) Remove the left cover. (Refer to page 3-11)
- 2) Remove the rear cover. (Refer to page 3-12)
- 3) Remove the right rear cover. (Refer to page 3-13)
- 4) Remove the ICB PCB. (Refer to page 3-101)
- 5) Remove the main controller PCB. (Refer to page 3-101)
- 6) Remove the low voltage power unit. (Refer to page 3-109)
- 7) Remove the lower high voltage power supply PCB. (Refer to page 3-115)
- 8) Remove the fan unit. (Refer to page 3-82)

Removing the Environment Sensor

- 1) Remove the sponge.
 - 2) Remove the environment sensor [1].
- 1 claw [2]

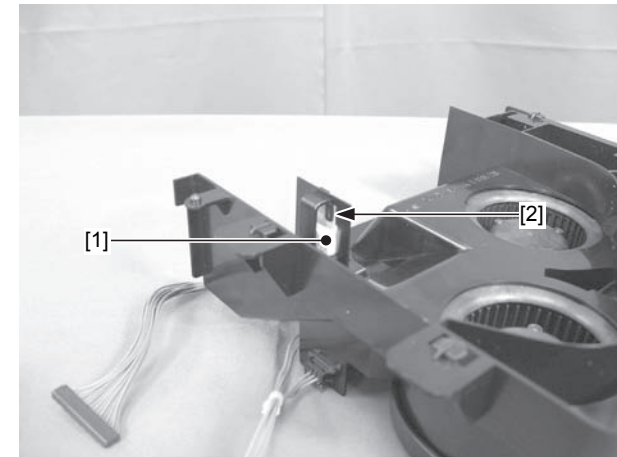

F-3-308

Caution :

At assembly, be careful not to forget to install the sponge.

Removing the Environment Sensor(LBP7780C/LBP5480)

Before Removing the Environment Sensor

- 1) Remove the left cover.(Refer to page 3-11)
- 2) Remove the rear cover.(Refer to page 3-12)
- 3) Remove the right rear cover.(Refer to page 3-13)
- 4) Remove the main controller PCB.(Refer to page 3-106)
- 5) Remove the low voltage power unit.(Refer to page 3-111)
- 6) Remove the lower high voltage power supply PCB.(Refer to page 3-117)
- 7) Remove the fan unit.(Refer to page 3-84)

Removing the Environment Sensor

- 1) Remove the sponge [1] and remove the environment sensor [2].
 - 1 claw [3]

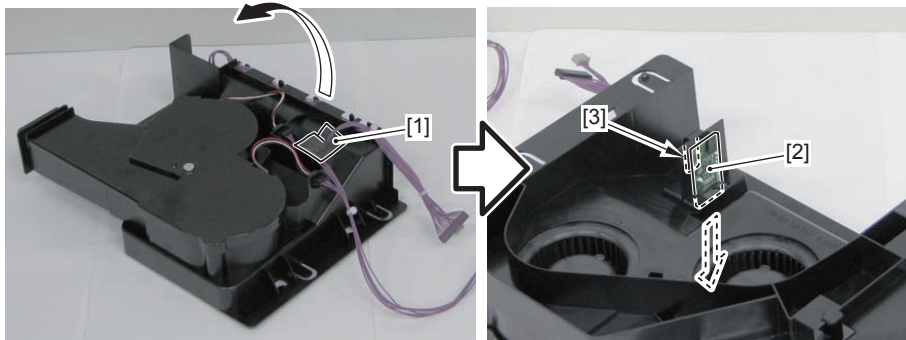

F-3-309

Caution :

At assembly, be careful not to forget to install the sponge.

4

Maintenance and Inspection

- Periodically Replaced Parts
- Consumable Parts
- Periodical Service
- Cleaning

Periodically Replaced Parts

Periodically Replaced Parts

No periodically replaced parts exist in this machine.

Consumable Parts

Consumable Parts Replaced by Users

There is a possibility that replacement of parts is needed due to deterioration or damage at least more than once during the product's warranty period. The following shows the estimated average life of the parts which need to be replaced after a failure occurs.

Parts name	Parts No.	Q'ty	Estimated life	Remarks
Waste toner container		1	18000 sheets	

T-4-1

Consumable Parts Replaced by Service Engineers

There is a possibility that replacement of parts is needed due to deterioration or damage at least more than once during the product's warranty period. The following shows the estimated average life of the parts which need to be replaced after a failure occurs.

Parts name	Parts No.		Quantity	Estimated life	Remarks
	LBP7750C LBP5460	LBP7780C LBP5480			
ITB unit	FM3-8817	FM3-9078	1	150000 prints	After replacement, it is necessary to reset the counter from service mode*1.
Fixing assembly	FM3-8815	FM3-8816(120V) FM3-8824(230V)	1	150000 prints	
Power fan	RK2-2416	RK2-2416	1	25000 hours	
Delivery fan	RK2-2418	RK2-2418	1	25000 hours	
Cartridge fan	RK2-2418	RK2-2418	1	25000 hours	

T-4-2

*1:Service mode

COUNTER GR. > INIT.XXX (XXX : Unit name)

Periodical Service

Periodical Service

No periodical service is needed for this machine.

Cleaning

Cleaning Item

Performed by	Area to be cleaned	Cleaning procedure
User	Fixing sleeve	Execute "Utility > Cleaning".
User	Outside of the printer, Vent	Wring the water out of a soft cloth moistened with water or watered-down mild detergent, and remove dirt with it. When dirt is removed, remove the detergent with a dried soft cloth.
Service engineer	Feed path guide	Clean the guide with lint-free paper. When too much dirt is attached, remove it with lint-free paper using alcohol.
Service engineer	Cassette pickup roller, Cassette separation roller, Multi-purpose tray paper pickup roller, Multi-purpose tray paper separation pad, Registration roller.	Clean the guide with lint-free paper. When too much dirt is attached, remove it with lint-free paper using alcohol.
Service engineer	Color displacement/density sensor unit	Open and close the front cover unit.

T-4-3

MEMO :
 Cleaning of the fixing sleeve by a user can be performed in the following menu.
 Utility key > Utility > Cleaning

MEMO :
 When a mild detergent is used, remove it with a soft cloth moistened with water later.

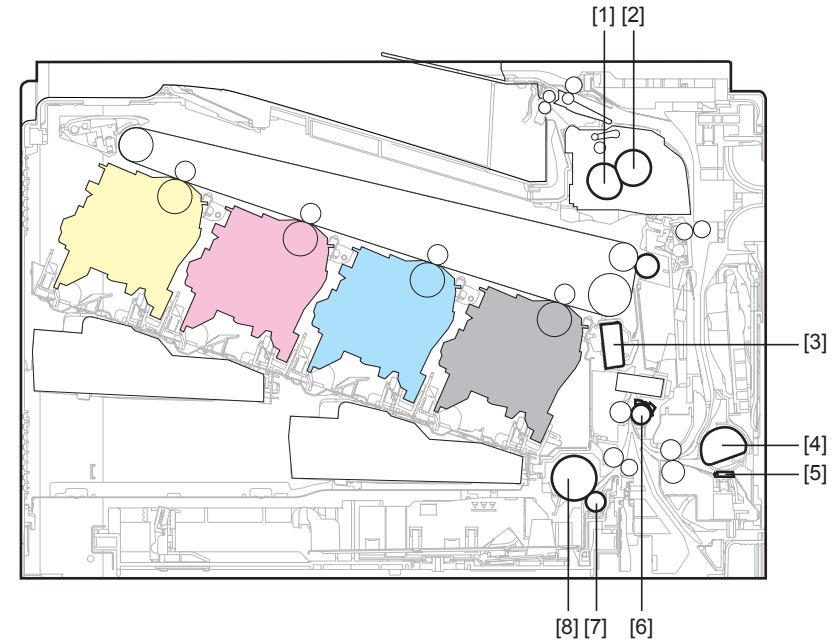

F-4-1

- [1] Fixing sleeve
- [2] Pressure roller
- [3] Color displacement/density sensor unit
- [4] Multi-purpose tray paper pickup roller
- [5] Multi-purpose tray separation pad
- [6] Registration roller
- [7] Cassette separation roller
- [8] Cassette pickup roller

5

Troubleshooting

- Corrective Actions
- Standard/Adjustment
- Outline of Electrical Components
- Connector Layout Drawing
- Service Tools
- Error Code
- Version Up
- Service Mode
- Debug Log
- Backup/Restoration by Expansion ROM for servicing and Sublog Board

Corrective Actions

Image Failure

Low Density (1)



F-5-1

The density of the entire printed image is obviously low.

Cause	Action
1) Contact failure at the contact point for grounding of the ITB unit	Clean the contact point at the printer side and that at the ITB unit side. If the failure cannot be removed after cleaning, check whether the contact point is deformed or damaged, and replace the faulty unit.
2) Contact failure at the contact point for the secondary transfer outer roller	Clean the contact point at the printer side and that at the secondary transfer outer roller side. If the failure cannot be removed after cleaning, check whether the contact point is deformed or damaged, and replace the faulty unit.

T-5-1

Low Density (2)



F-5-2

The density of all specific colors in the printed image is obviously low.

Cause	Action
1) Contact failure at the contact point for the primary transfer bias of the ITB unit	Clean the contact point at the printer side and that for the primary transfer bias of the color of which density is low. If the failure cannot be removed after cleaning, check whether the contact point is deformed or damaged, and replace the faulty unit.
2) Contact failure at the contact point for the primary charging bias of the cartridge	Clean the contact point at the printer side and that for the primary charging bias of the color of which density is low. If the failure cannot be removed after cleaning, check whether the contact point is deformed or damaged, and replace the faulty unit.
3) Contact failure at the contact point for the developing bias of the cartridge	Clean the contact point at the printer side and that for the developing bias of the color of which density is low. If the failure cannot be removed after cleaning, check whether the contact point is deformed or damaged, and replace the faulty unit.

T-5-2

High Density



F-5-3

The density of printed image is obviously high.

Cause	Action
1) Failure in the color displacement/density sensor	Replace the color displacement/density sensor unit.

T-5-3

Blank Image

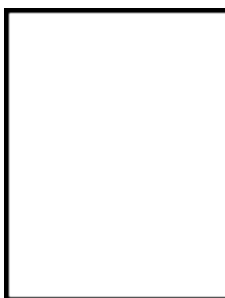

F-5-4

No image is printed.

Cause	Action
1) Failure in the lower high-voltage power supply PCB (No developing bias is output.)	Replace the lower high-voltage power supply PCB.

T-5-4

Coal-black/Solid Color Image

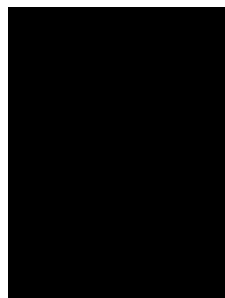

F-5-5

An inky-black or solid color image is printed.

Cause	Action
1) Failure at the contact point for the primary charging bias / developing bias of the cartridge	Clean the contact point at the printer side and that for the cartridge of the target color. If the failure cannot be removed after cleaning, check whether the contact point is deformed or damaged, and replace the faulty unit.

T-5-5

Polka-dot Pattern

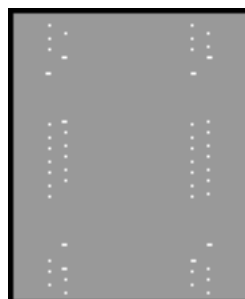

F-5-6

An image with polka-dot pattern is printed.

Cause	Action
1) Dirt on the static eliminator	Clean the static eliminator.
2) Deformation/deterioration of the primary transfer roller	Replace the ITB unit.
3) Deformation/deterioration of the secondary transfer outer roller	Replace the secondary transfer outer roller.

T-5-6

■ Dirt on the Backside

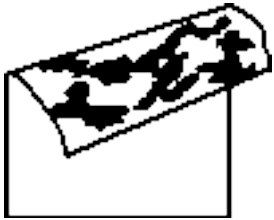

Dirt is attached on the backside of the paper.

F-5-7

Cause	Action
1) Dirt on the secondary transfer outer roller	Replace the secondary transfer outer roller.
2) Dirt on the fixing inlet guide, separation guide	Remove the dirt. If it cannot be removed, replace the fixing assembly.
3) Dirt on the pressure roller	Execute pressure roller cleaning specification in the multi-purpose mode. If the dirt cannot be removed, replace the fixing assembly.

T-5-7

■ Vertical Line

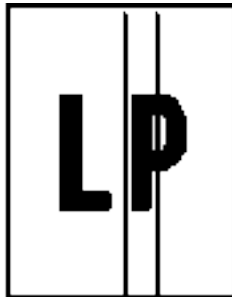
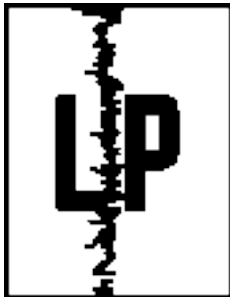

Vertical lines are printed.

F-5-8

Cause	Action
1) Scratch in peripheral direction on the photosensitive drum	Replace the cartridge for which vertical lines occurred.
2) Scratch in peripheral direction on the fixing sleeve	Replace the fixing assembly.
3) Scratch in peripheral direction on the ITB	Replace the ITB unit.
4) Deformation/deterioration of the ITB drive roller	Replace the ITB unit.
5) ITB cleaning failure	Replace the ITB unit.

T-5-8

■ White Vertical Line (1)



White vertical lines are printed in a specific color.

F-5-9

Cause	Action
1) A foreign matter is attached on the glass of the laser output assembly in this machine.	Remove the foreign matter.
2) Scratch in peripheral direction on the developing roller/photosensitive drum	Replace the cartridge of the color for which white vertical lines occurred.
3) Dirt on the mirror of the laser/scanner assembly	Replace the laser/scanner assembly.

T-5-9

■ White Vertical Line (2)



White vertical lines are printed in all colors.

F-5-10

Cause	Action
1) Scratch in vertical direction on the fixing sleeve	Replace the fixing assembly
2) Scratch in peripheral direction on the ITB	Replace the ITB.

T-5-10

Horizontal Line

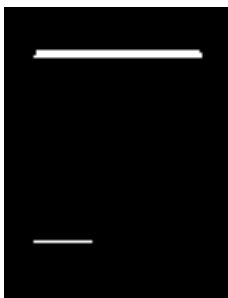

Horizontal lines are printed.

F-5-11

Cause	Action
1) Horizontal lines printed periodically	Identify the roller causing the trouble based on the interval of horizontal lines. If dirt cannot be removed, replace the unit including the target roller.
2) Scratch in horizontal direction on the photosensitive drum	Replace the cartridge of the color for which horizontal lines occurred.
3) Scratch in horizontal direction on the fixing sleeve	Replace the fixing assembly.

T-5-11

White Horizontal Line



White horizontal lines are printed.

F-5-12

Cause	Action
1) White horizontal lines printed periodically	Identify the roller causing the trouble based on the interval of white horizontal lines. If dirt cannot be removed, replace the unit including the target roller.
2) Scratch in horizontal direction on the photosensitive drum	Replace the cartridge of the color for which horizontal lines occurred.
3) Scratch in horizontal direction on the ITB	Replace the ITB unit.

T-5-12

Dropout of a Specific Color

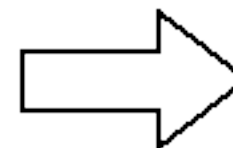
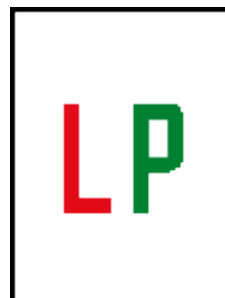

F-5-13

An image is printed in which a specific color is dropped.

Cause	Action
1) Contact failure at the contact point for the developing bias/primary charging bias of the cartridge	Clean the contact point at the printer side and that for the cartridge for which color dropout occurred. If the failure cannot be removed after cleaning, check whether the contact point is deformed or damaged, and replace the faulty unit.
2) Failure in the cartridge (primary charging roller, developing roller, photosensitive drum)	Replace the cartridge of the color for which color dropout occurred.
3) Failure in the Lower high-voltage power supply PCB (No developing bias or primary charging bias is output.)	Replace the Lower high-voltage power supply PCB.
4) Failure in the laser scanner unit	Replace the laser scanner unit of the color for which color dropout occurred.

T-5-13

White Patch

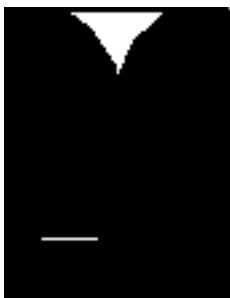

F-5-14

An image with white patches is printed.

Cause	Action
1) Deformation/deterioration of the secondary transfer outer roller	Replace the secondary transfer outer roller.
2) Deformation/deterioration of the primary charging roller, developing roller, and photosensitive drum	Replace the cartridge of the color for which white patches occurred.
3) Deformation/deterioration of the fixing sleeve	Replace the fixing assembly.
4) Failure in the upper high-voltage power supply PCB (Poor transfer bias output)	Replace the upper high-voltage power supply PCB.

T-5-14

Fixing Failure

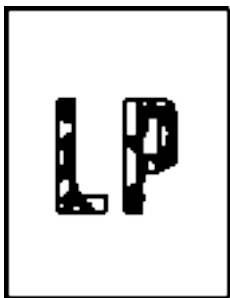

F-5-15

An image on which toner is not fully fixed is printed.

Cause	Action
1) Scratch/deformation on/of the fixing sleeve or pressure roller	Replace the fixing assembly.
2) Failure in the fixing control circuit	Replace the low-voltage power supply PCB.
3) Failure in the thermistor	Replace the fixing assembly.
4) Failure in the fixing heater	Replace the fixing assembly.

T-5-15

Color Displacement



F-5-16

An image in which color is displaced is printed.

Cause	Action
1) Lack of calibration	Forcibly execute calibration.
2) Failure in the ITB unit	If the ITB does not rotate smoothly, replace the ITB unit. If a cleaning failure (dirt on the ITB) occurred, replace the ITB unit.
3) Wear/cut on the drive gear of the ITB motor (Drum motor 3)	Check each drive gear between the ITB drive roller and the ITB motor (Drum motor 3). If wear/cut is found on the gear, replace the drive assembly.
4) Failure in the color displacement/density sensor	Open and close the front door several times, and clean the color displacement/density sensor. If the failure cannot be removed, replace the color displacement/density sensor.
5) Failure in the laser scanner unit	Replace the laser scanner unit.
6) Failure in the cartridge	Replace the cartridge of the color for which color displacement occurred.

T-5-16

Image Trouble

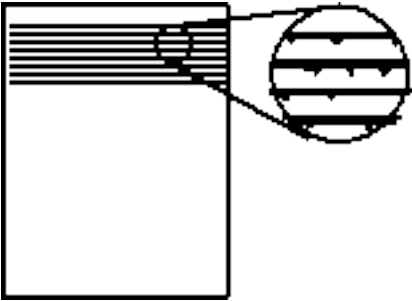

A fading image or trouble image is printed.

F-5-17

Cause	Action
1) Residual paper which has not been processed remains in the machine.	Remove the residual paper.
2) Contact failure at the contact point for grounding of the cartridge	Clean the contact point at the printer side and that for grounding of each cartridge. If the failure cannot be removed after cleaning, check whether the contact point is deformed or damaged, and replace the faulty unit.
3) Foreign matter or dirt attached on the fixing inlet guide	Clean the fixing inlet guide.

T-5-17

Skew/Displacement of an Image



A skewed image or displaced image is printed.

F-5-18

Cause	Action
1) Skew of the paper	Remove the cause of the skew following the procedure shown in "■ Skewed image".
2) Failure in the laser scanner unit	Replace the laser scanner unit.

T-5-18

Wrinkle/Bend at the Leading Edge



There is wrinkle or bend at the leading edge of the delivered paper.

F-5-19

Cause	Action
1) Dirt on the feed roller/feed guide	Clean the dirty area.
2) Deformation/wear of the feed roller	Replace the feed roller unit where deformation/wear occurred.
3) Scratch on the feed guide	Replace the feed guide unit.

T-5-19

Skewed Image

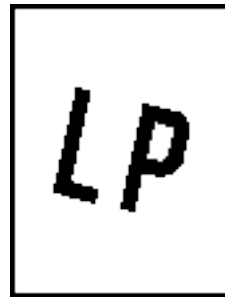

A skewed image is printed in the paper.

F-5-20

Cause	Action
1) The spring of the registration shutter is removed.	If the spring is removed, fix it at a correct position.
2) The spring of the registration shutter is deformed.	Replace the secondary transfer assembly.

T-5-20

Dirt



F-5-21

Dirt is attached on the printing surface.

Cause	Action
1) Dirt on the photosensitive drum	Replace the cartridge.
2) Dirt on the fixing sleeve/pressure roller	Execute pressure roller cleaning specification in the multi-purpose mode. If the dirt cannot be removed, replace the fixing assembly.

T-5-21

Interval of Dirt or White Patches on the Image

Faulty part	Image interval (mm)	Symptom			
		Dirt	White patch	Dirt on the backside	Fixing failure
Secondary transfer outer roller	Approx. 50		○	○	
Primary charging roller	Approx. 27		○		
Photosensitive drum	Approx. 75	○	○		
Developing roller	Approx. 32		○		
Fixing sleeve	Approx. 78	○	○		○
Pressure roller	Approx. 75	○		○	○

T-5-22

Caution :

Cleaning cannot be performed to the primary charging roller, photosensitive drum, and developing roller because they are mounted inside of the cartridge. If the failure occurred in these rollers, replace the cartridge.

Standard/Adjustment

Test Print

Engine Test Print

A test print is performed to check whether this machine operates correctly or not. For the test print, two types of test print are performed; an engine test print and a controller test print. When a failure occurs in this machine, a printer failure can be identified by performing the test print.

The engine test print is performed to check whether the printer engine operates correctly or not. When the test print switch on the PCB is pressed, the test pattern shown below is printed.

LBP7750C/LBP5460



F-5-24

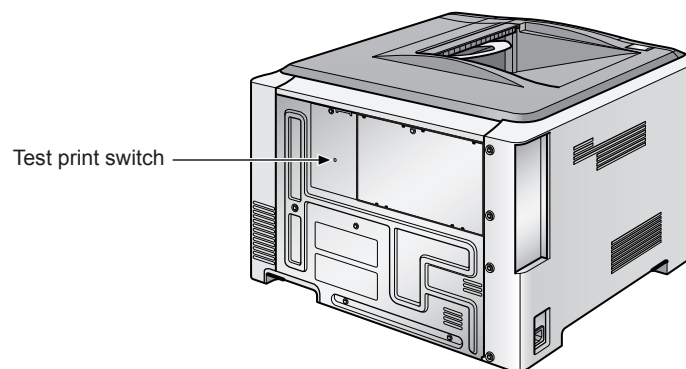

LBP7780C/LBP5480

F-5-22

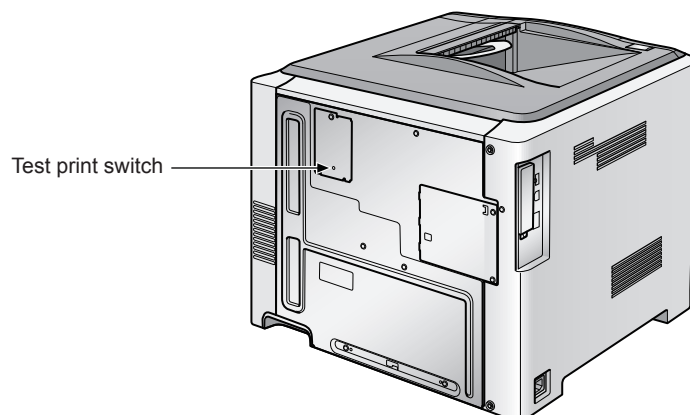

F-5-23

Adjustment of the Image Formation System

When Replacing the ITB Unit

Clear the counter value using the following service mode after replacing the ITB.

Service mode > COUNTER GR. > INIT.ITB UNIT

Adjustment of the Fixing Assembly

When Replacing the Fixing Assembly

Clear the counter value using the following user mode and service mode after replacing the fixing assembly.

Service mode

COUNTER GR. > INIT > INIT.FIX.COUNT

Checking the Pressure Volume (Nip Volume) of the Pressure Roller

Although the nip volume of the fixing assembly cannot be adjusted in this machine, an inappropriate nip volume may cause a fixing failure.

Therefore, check the nip volume of the fixing assembly following the procedure shown below.

- 1) Bring an A4-size coal-black printing sheet output by the cartridge of this machine when visiting the customer.
- 2) Set the coal-black printing sheet in the cassette of this machine, placing the printing side downward.
- 3) Print a whole white image using an external device.
- 4) Open the front door at the timing when the leading edge of the sheet comes out from the delivery roller of the delivery tray, leave it untouched for more than 10 seconds, and remove the printing sheet.
- 5) Measure the width of the glossy toner area on the printing sheet as shown in the figure below, and check whether the width is within the range shown below.

If the nip volume is not within the standard, replace the fixing assembly.

- Center (a): $8.5 \pm 0.7\text{mm}$
- Edges (b), (c): 8.7 to 9.9mm
- Difference between right and left (| b - c |): Less than 0.7mm

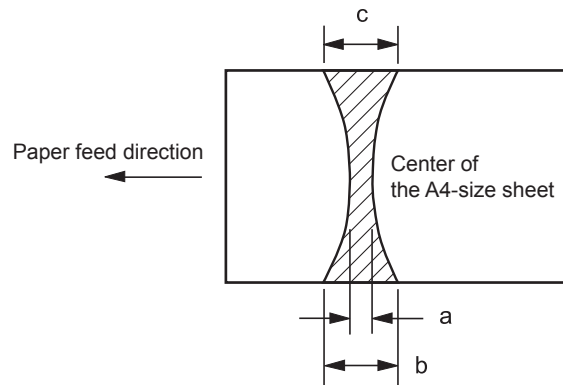

F-5-25

● Adjustment of Electrical Parts

■ When Replacing the DC Controller PCB

Information of the NVRAM mounted on the DC controller PCB is saved in the NVRAM on the main controller PCB.

The backup data can be restored to the NVRAM on the DC controller PCB by executing the printer restore setting via the service mode.

When replacing the DC controller PCB, be sure to execute backup data restore, color displacement correction, and calibration via the service mode.

- 1) Execute "Service mode > FUNCTION GR. > RESTORE DCON
- 2) Turn off the host machine.
- 3) Execute "Utility > Calibration > Full calibration

● LBP7780C/LBP5480

NVRAM information on the DC Controller PCB is stored in the NVRAM on the Main Controller PCB as a backup.

The data that has been backed up can be restored to the NVRAM on the DC Controller PCB in the service mode.

- 1) Execute the following: service mode > FUNCTION GR.>RESTORE DCON.
- 2) Turn OFF and then ON the power of the host machine.

■ Replacing the Main Controller PCB

Setting values and management data of this machine are memorized in the NVRAM (IC475) on the main controller PCB.

When replacing the main controller PCB, be sure to remove the NVRAM (IC475) from the old PCB and attach it to the new PCB to keep user mode settings.

Be sure to execute color displacement correction and calibration after the NVRAM is attached to the new PCB.

- 1) Turn on the host machine.
- 2) Execute "Utility > Calibration > Full calibration"

● LBP7780C/LBP5480(In case of machine without MEAP)

Because setting values and management data of this machine are stored in the flash memory of the Main Controller PCB, they need to be backed up before replacing the Main Controller PCB.

However, when the Main Controller PCB cannot operate normally because of flash memory failure or system error, the above data cannot be backed up.

Setting values of this machine: User mode setting values, service mode setting values

Management data of this machine: Page counter, device serial number

1 Backup and restoration of data using Expansion ROM for servicing and Sublog Board (or Sublog Board attached with the Expansion ROM hereafter)

Since setting values and management data can all be backed up by this method, all data can be restored by restoring the backup data after replacing the PCB.

2 Backup and restoration of data using USB memory

Since only setting values can be backed up by this method.

3 When data cannot be backed up before replacement due to Main Controller PCB error

Backing up data kept by the NVRAM of the DC Controller PCB to the Main Controller PCB

● 1 Backup and restoration of data using Sublog Board attached with Expansion ROM

For details, refer to the Service Manual > Chapter 5 Troubleshooting > Backup/Restoration by Expansion ROM for servicing and Sublog Board

1-1 Backing up data before replacing the PCB

Perform the following operation to back up data of the Main Controller PCB to the Sublog Board attached with the Expansion ROM.

- Turn OFF the power.
- Install the Expansion ROM for servicing to the Sublog Board.
- Install the Sublog Board attached with the Expansion ROM to the Main Controller PCB.
- Turn ON the power.
- When turning ON the power, "NVRAM export" is displayed on the Control Panel.
- Press the down arrow key.
- All data stored on the Main Controller PCB is backed up to the Sublog Board attached with the Expansion ROM.

1-2 Replacing the PCB

- Turn OFF the power.
- Remove the Sublog Board attached with the Expansion ROM from the Main Controller PCB.
- Replace the Main Controller PCB with a new one (service part).
- Install the Sublog Board attached with the Expansion ROM to the Main Controller PCB.

1-3 Restoring data after replacing the PCB

Perform the following operation to restore data backed up in the Sublog Board attached with the Expansion ROM to the Main Controller PCB.

- Turn ON the power.

- When the menu is displayed on the Control Panel upon turning ON the power, select "NVRAM import".
- Press the down arrow key.
- Data backed up in the Sublog Board attached with the Expansion ROM is restored to the Main Controller PCB.
- Turn OFF the power, and remove the Sublog Board attached with the Expansion ROM.

● 2 Backup and restoration of data using USB memory

2-1 Backing up data before replacing the PCB

Perform the following operation to back up data of the Main Controller PCB to the USB memory.

- Connect the USB memory to the host machine.
- Select Setup Menu>SERVICE MODE>FUNCTION GR.>USB-H>On.
- Back up data of the Main Controller PCB to the USB memory.
Select Setup Menu>SERVICE MODE>FUNCTION GR.>ECONF>EXPORT>ALL>Yes.
- Select Setup Menu>SERVICE MODE>FUNCTION GR.>USB-H>Off.
- Disconnect the USB memory from the host machine.

2-2 Replacing the PCB

- Turn OFF the power.
- Replace the Main Controller PCB with a new one (service part).

2-3 Performing operation after power-on.

Turn ON the power.

- "Initializing NVRAM" is displayed on the Control Panel for a few seconds.
- "Panel Language" is displayed.
- Here, select your own language.
- When the date setting screen appears, set the date and then press the OK key.
- When the time setting screen appears, set the time and then press the OK key.
- After the message "Setting Completed" appears, the message "Ready to print" appears, indicating the machine can be used normally.

2-4 Restoring data after replacing the PCB

Perform the following operation to restore data backed up in the USB memory to the Main Controller PCB.

- Connect the USB memory to the host machine.
- Select Setup Menu>SERVICE MODE>FUNCTION GR.>USB-H>On.
- Restore data backed up in the USB memory to the Main Controller PCB.
Select Setup Menu>SERVICE MODE>FUNCTION GR.>ECONF>IMPORT>Yes.
- Select Setup Menu>SERVICE MODE>FUNCTION GR.>USB-H>Off.
- Disconnect the USB memory from the host machine.

NOTE

When you execute Setup Menu>SERVICE MODE>FUNCTION GR.>ECONF>EXPORT>ALL>Yes upon backup of data by the USB memory, information kept by NVRAM on the DC Controller PCB is also backed up. Therefore, if "ALL" is selected, the operation to back up the information kept by NVRAM of the DC Controller PCB is not necessary.

● 3 When data cannot be backed up before replacement due to Main Controller PCB error

When the Main Controller PCB cannot operate normally, then backup of various data is not possible.

In this case, perform the following procedure to replace the PCB.

3-1 Replacing the PCB

- Turn OFF the power.
- Replace the Main Controller PCB with a new one (service part).

3-2 Performing operation after power-on.

- Turn ON the power.
- "Initializing NVRAM" is displayed on the Control Panel for a few seconds.
- "Panel Language" is displayed.
- Here, select your own language or English.
- When the date setting screen appears, set the date and then press the OK key.
- When the time setting screen appears, set the time and then press the OK key.
- After the message "Setting Completed" appears, the message "Ready to print" appears, indicating the machine can be used normally.

3-3 Backing up data kept by the NVRAM of the DC Controller PCB to the Main Controller PCB

- Initialize the DC Controller NVRAM backup area kept in the Main Controller PCB.

Select Setup Menu>SERVICE MODE>FUNCTION GR.>CLEAR DCON.

- Turn OFF and then ON the power.
- By turning OFF and then ON the power, data kept by the DC Controller PCB NVRAM is backed up to the DC Controller NVRAM backup area in the Main Controller PCB.

● LBP7780C/LBP5480(In case of machine with MEAP)

Because setting values, management data of this machine and the MEAP application, etc. are stored in the flash memory of the Main Controller PCB, they need to be backed up before replacing the Main Controller PCB. However, when the Main Controller PCB cannot operate normally because of flash memory failure or system error, the above data cannot be backed up.

Also, restoration of the backup data and reinstallation of the MEAP application is necessary

after replacing the Main Controller PCB.

Setting values of this machine: User mode setting values, service mode setting values
Management data of this machine: Page counter, device serial number

1 Backup and restoration of data using Expansion ROM for servicing and Sublog Board (or Sublog Board attached with the Expansion ROM hereafter)

While setting values and management data can be backed by this method, the MEAP application cannot be backed up by the method. Therefore, reinstallation of the MEAP application is necessary after replacing the PCB and then restoring the backup data.

2 Backup and restoration of data using USB memory

Only setting values can be backed up by this method. Therefore, reinstallation of the MEAP application is necessary after replacing the PCB and then restoring the backup data.

3 When data cannot be backed up before replacement due to Main Controller PCB error
Reinstallation of the MEAP application is necessary after replacing the PCB.

● 1 Backup and restoration of data using Sublog Board attached with Expansion ROM and copy of data using laptop PC for servicing

1-1 Actions before replacing the PCB

1-1-1 Preparation required for reinstalling the MEAP application

For details on preparation required for reinstalling the MEAP application, refer to the Service Manual > Chapter 2 Technical Description > MEAP > Maintenance > Procedure for reinstalling MEAP applications after replacing the PCB.

1-1-2 Backing up to Sublog Board attached with the Expansion ROM

For details on backup to Sublog Board attached with the Expansion ROM, refer to the Service Manual > Chapter 5 Troubleshooting > Backup/Restoration by Expansion ROM for servicing and Sublog Board

- Turn OFF the power.
- Install the Expansion ROM for servicing to the Sublog Board.
- Install the Sublog Board attached with the Expansion ROM to the Main Controller PCB.
- Turn ON the power.
- When turning ON the power, "NVRAM export" is displayed on the Control Panel.
- Press the down arrow key.
- The data of the Main Controller PCB is backed up to the Sublog Board attached with the Expansion ROM.

1-2 Replacing the PCB

- Turn OFF the power.
- Replace the Main Controller PCB with a new one (service part).

- Install the Sublog Board attached with the Expansion ROM to the Main Controller PCB.
- 1-3 Restoring data after replacing the PCB
Perform the following operation to restore data backed up in the Sublog Board attached with the Expansion ROM to the Main Controller PCB.
- Turn ON the power.
 - When the menu is displayed on the Control Panel upon turning ON the power, select "NVRAM import".
 - Press the down arrow key.
 - Data backed up in the Sublog Board attached with the Expansion ROM is restored to the Main Controller PCB.
 - Turn OFF the power, and remove the Sublog Board attached with the Expansion ROM.
- 1-4 Reinstalling the MEAP application and importing user information
For details on preparation required for reinstalling the MEAP application and importing user information, refer to the Service Manual > Chapter 2 Technical Description > MEAP > Maintenance > Procedure for reinstalling MEAP applications after replacing the PCB.
- **2 Backup and restoration of data using USB memory and copy of data using laptop PC for servicing**
- 2-1 Actions before replacing the PCB
2-1-1 Preparation required for reinstalling the MEAP application
For details on preparation required for reinstalling the MEAP application, refer to the Service Manual > Chapter 2 Technical Description > MEAP > Maintenance > Procedure for reinstalling MEAP applications after replacing the PCB.
- 2-1-2 Backup to USB memory
- Connect the USB memory to the host machine.
 - Select Setup Menu>SERVICE MODE>FUNCTION GR.>USB-H>On.
 - Back up data of the Main Controller PCB to the USB memory.
Select Setup Menu>SERVICE MODE>FUNCTION GR.>ECONF>EXPORT>ALL>Yes.
 - Select Setup Menu>SERVICE MODE>FUNCTION GR.>USB-H>Off.
 - Disconnect the USB memory from the host machine.
- 2-2 Replacing the PCB and turning ON the power
- Turn OFF the power.
 - Replace the Main Controller PCB with a new one (service part).
 - Turn ON the power.
 - The equipment is started and can be used normally.
- 2-3 Restoring data after replacing the PCB
Perform the following operation to restore data backed up in the USB memory to the Main Controller PCB.

- Connect the USB memory to the host machine.
- Select Setup Menu>SERVICE MODE>FUNCTION GR.>USB-H>On.
- Restore data backed up in the USB memory to the Main Controller PCB.
Select Setup Menu>SERVICE MODE>FUNCTION GR.>ECONF>IMPORT>Yes.
- Select Setup Menu>SERVICE MODE>FUNCTION GR.>USB-H>Off.
- Disconnect the USB memory from the host machine.

NOTE

When you execute Setup Menu>SERVIVE MODE>FUNCTIONGR.>ECONF>EXPORT>ALL>Yes upon backup of data by the USB memory, information kept by NVRAM on the DC Controller PCB is also backed up. Therefore, if "ALL" is selected, the operation to back up the information kept by NVRAM of the DC Controller PCB is not necessary.

2-4 Reinstalling the MEAP application and importing user information

For details on preparation required for reinstalling the MEAP application and importing user information, refer to the Service Manual > Chapter 2 Technical Description > MEAP > Maintenance > Procedure for reinstalling MEAP applications after replacing the PCB.

● **3 When data backup from the Main Controller PCB is not possible**

When the Main Controller PCB cannot operate normally, then backup of various data is not possible.

In this case, perform the following procedure to replace the PCB.

3-1 Replacing the PCB and turning ON the power

- Turn OFF the power.
- Replace the Main Controller PCB with a new one (service part).
- Turn ON the power.
- The equipment is started and can be used normally.

3-2 Backing up data kept by the NVRAM of the DC Controller PCB to the Main Controller PCB

- Perform the following operation to initialize the DC Controller NVRAM backup area of the Main Controller PCB.
Select Setup Menu>SERVICE MODE>FUNCTION GR.>CLEAR DCON.
- Turn OFF and then ON the power.
- By turning OFF and then ON the power, information kept by the DC Controller PCB NVRAM is backed up to the DC Controller NVRAM backup area in the Main Controller PCB.

3-3 Reinstalling the MEAP application

For details on reinstalling the MEAP application, refer to the Service Manual > Chapter 2 Technical Description > MEAP > Maintenance > Procedure for reinstalling MEAP applications after replacing the PCB.

Outline of Electrical Components

Sensor



F-5-26

Symbol	Parts name	Symbol	Parts name
SR1	Drum home position sensor 1	SR7	Fixing pressure release sensor
SR2	Drum home position sensor 2	SR8	TOP sensor
SR3	Drum home position sensor 3	SR11	Developing home position sensor
SR6	Delivery tray full level sensor		

T-5-23

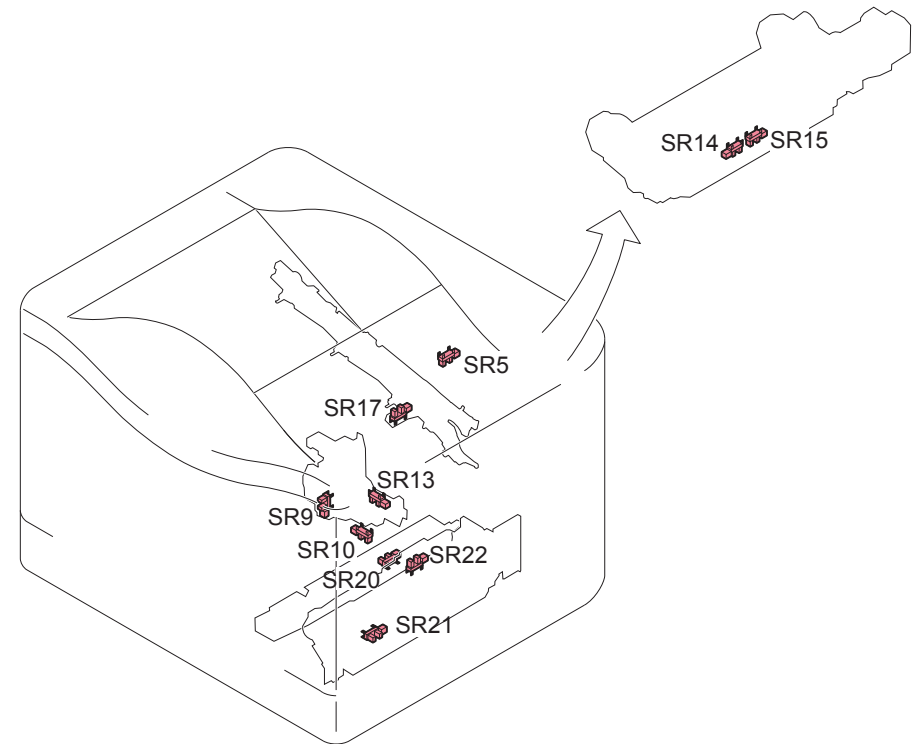

Symbol	Parts name	Symbol	Parts name
SR5	Fixing delivery sensor	SR17	Primary transfer roller disengagement sensor
SR9	Cassette media stack surface sensor	SR20	Cassette media presence sensor
SR13	Cassette presence sensor	SR21	Multi-purpose tray media presence sensor
SR14	Loop sensor 1	SR22	Duplex re-pickup sensor
SR15	Loop sensor 2	SR10	Auto close sensor(LBP7780C/ LBP5480 only)

T-5-24

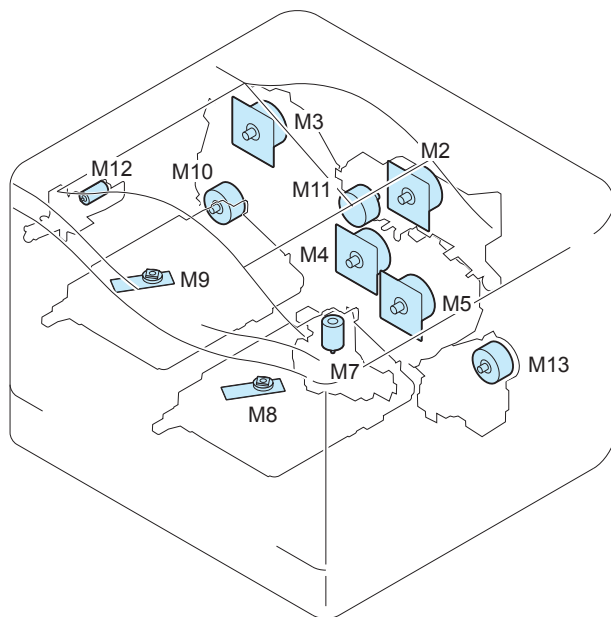
 Motor

F-5-27

Symbol	Parts name
M2	Fixing motor
M3	Drum motor 1
M4	Drum motor 2
M5	Drum motor 3
M7	Lifter motor
M8	C/Bk scanner motor
M9	Y/M scanner motor
M10	Developing disengagement sensor
M11	Duplex reverse motor
M12	Waste toner feed motor
M13	Pickup motor

T-5-25

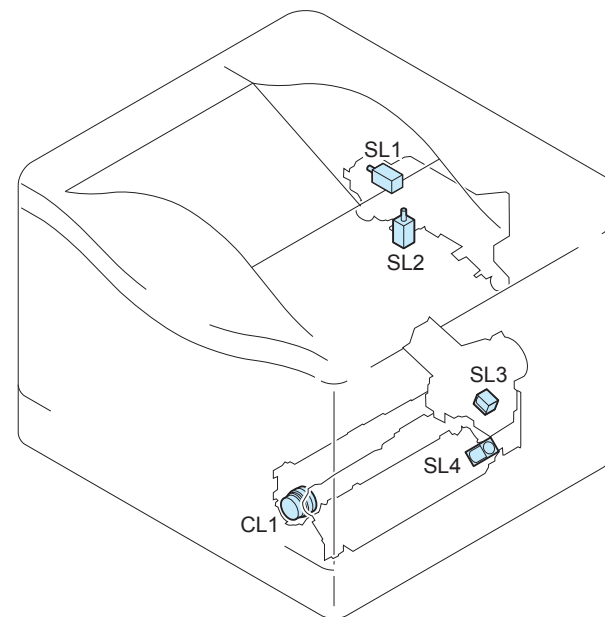
 Clutch/Solenoid

F-5-28

Symbol	Parts name
CL1	Duplex re-pickup clutch
SL1	Primary transfer roller disengagement solenoid
SL2	Duplex reverse solenoid
SL3	Multi-purpose tray pickup solenoid
SL4	Cassette pickup solenoid

T-5-26

Fan

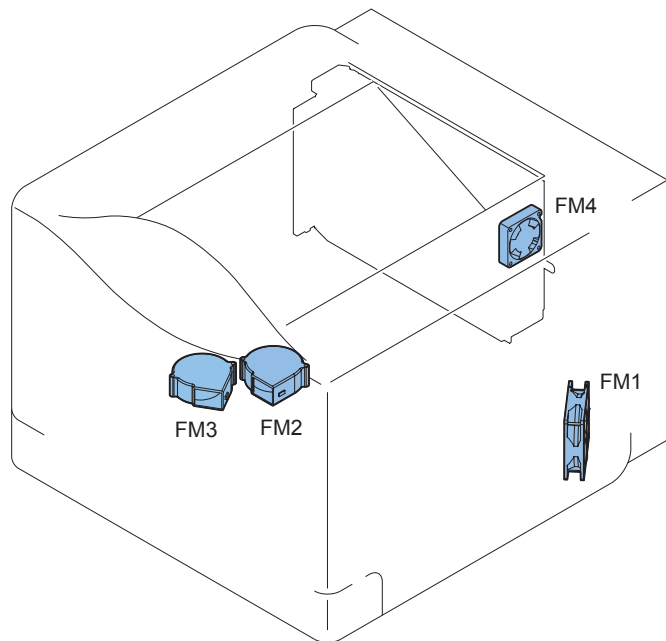

F-5-29

Symbol	Parts name
FM1	Power supply fan
FM2	Cartridge fan
FM3	Delivery fan
FM4	Controller fan (Not supported by LBP7780C) (Not supported by LBP5480)

T-5-27

LED/Heater/Thermistor/Switch

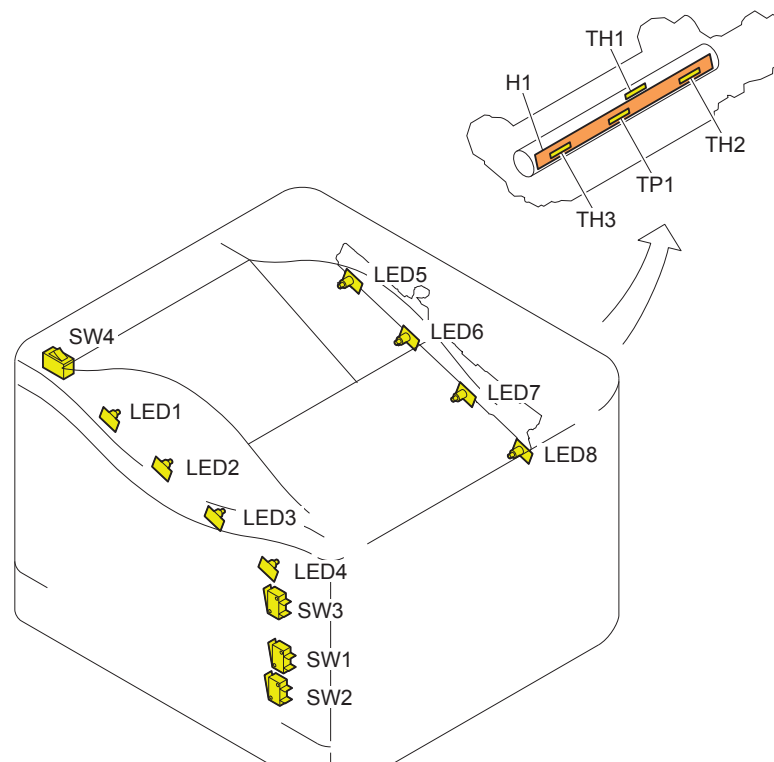

F-5-30

Symbol	Parts name	Symbol	Parts name
LED1	Front side pre-exposure LED 1	TH1	Sleeve thermistor
LED2	Front side pre-exposure LED 2	TH2	Main thermistor
LED3	Front side pre-exposure LED 3	TH3	Sub thermistor
LED4	Front side pre-exposure LED 4	TP1	Temperature fuse
LED5	Rear side pre-exposure LED 1	SW1	5V interlock switch 1
LED6	Rear side pre-exposure LED 2	SW2	5V interlock switch 2
LED7	Rear side pre-exposure LED 3	SW3	24V interlock switch
LED8	Rear side pre-exposure LED 4	SW4	Power switch (Not supported by LBP7780C) (Not supported by LBP5480)
H1	Fixing heater 1		

T-5-28



LBP7750C/LBP5460

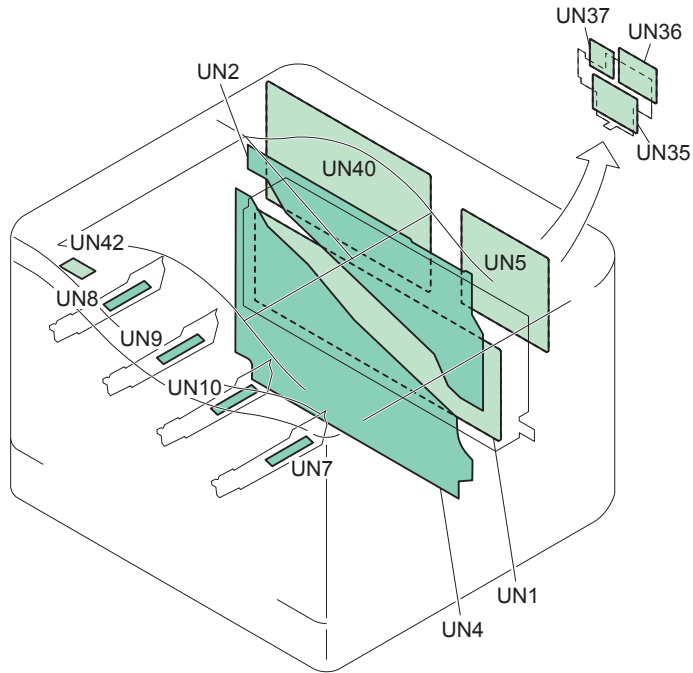

F-5-31

Symbol	Parts name
UN1	Low-voltage power supply PCB
UN2	Upper high-voltage power supply PCB
UN4	Lower high-voltage power supply PCB
UN5	DC controller PCB
UN7	Bk toner sensor PCB
UN8	Y toner sensor PCB
UN9	M toner sensor PCB
UN10	C toner sensor PCB
UN35	Driver PCB 1
UN36	Driver PCB 2
UN37	Driver PCB 3
UN40	Main controller PCB
UN42	Power switch relay PCB

T-5-29

LBP7780C/LBP5480

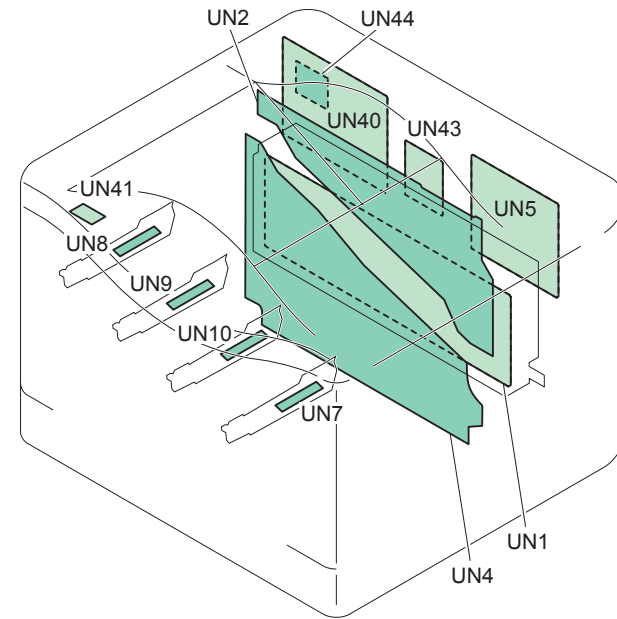

F-5-32

Symbol	Parts name
UN1	Low-voltage power supply PCB
UN2	Upper high-voltage power supply PCB
UN4	Lower high-voltage power supply PCB
UN5	DC controller PCB
UN7	Bk toner sensor PCB
UN8	Y toner sensor PCB
UN9	M toner sensor PCB
UN10	C toner sensor PCB
UN40	Main controller PCB
UN41	Power switch PCB
UN43	Sleep IF PCB
UN44	SD card PCB

T-5-30

Symbol	Parts name
UN1	Low-voltage power supply PCB
UN2	Upper high-voltage power supply PCB
UN4	Lower high-voltage power supply PCB
UN5	DC controller PCB
UN7	Bk toner sensor PCB
UN8	Y toner sensor PCB
UN9	M toner sensor PCB
UN10	C toner sensor PCB
UN35	Driver PCB 1
UN36	Driver PCB 2
UN37	Driver PCB 3
UN40	Main controller PCB
UN42	Power switch relay PCB

T-5-31

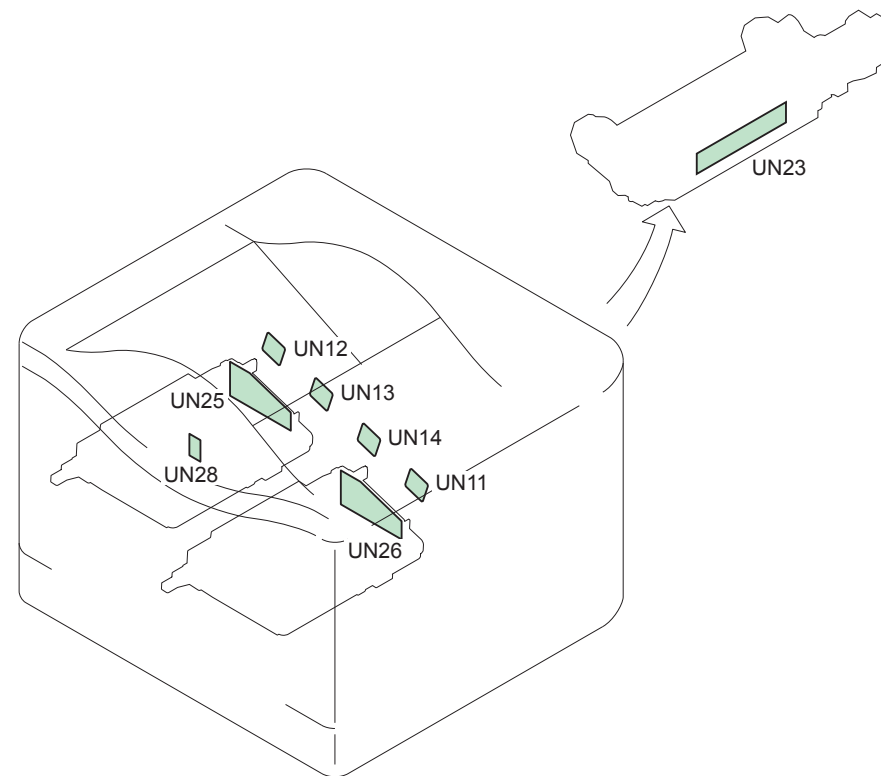

F-5-33

Symbol	Parts name
UN11	Bk memory tag relay PCB
UN12	Y memory tag relay PCB
UN13	M memory tag relay PCB
UN14	C memory tag relay PCB
UN23	Fixing relay PCB
UN25	YM laser driver PCB
UN26	CK laser driver PCB
UN28	Environment sensor PCB

T-5-32

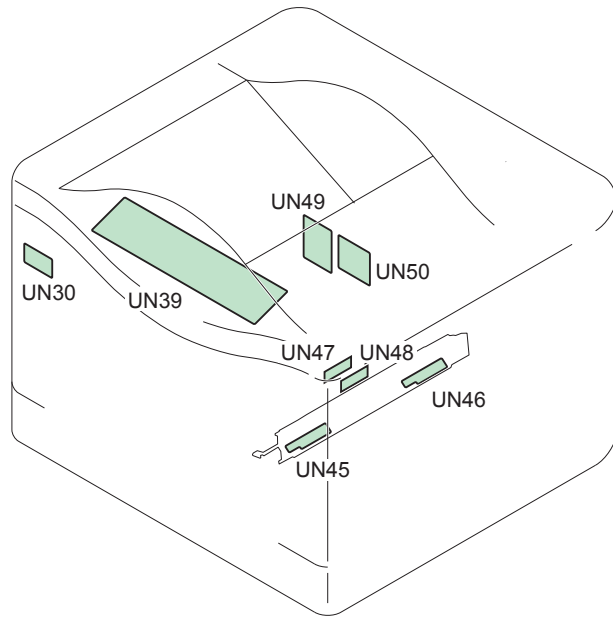

F-5-34

Symbol	Parts name
UN30	Waste toner full level sensor PCB
UN39	Control panel PCB
UN45	Color displacement/density sensor PCB 1
UN46	Color displacement/density sensor PCB 2
UN47	OHT IN(LBP7780C/LBP5480 only)
UN48	OHT OUT(LBP7780C/LBP5480 only)
UN49	Relay PCB(LBP7780C/LBP5480 only)
UN50	Aii night PCB(LBP7780C/LBP5480 only)

T-5-33

Connector Layout Drawing

Connector List(LBP7750C/LBP5460)

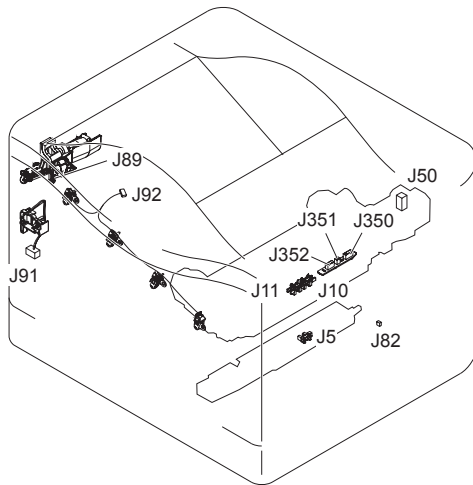
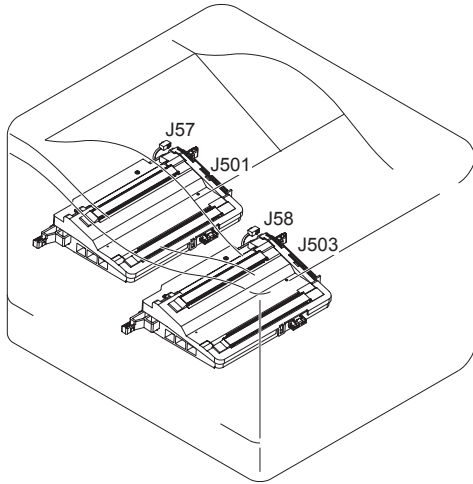

F-5-35

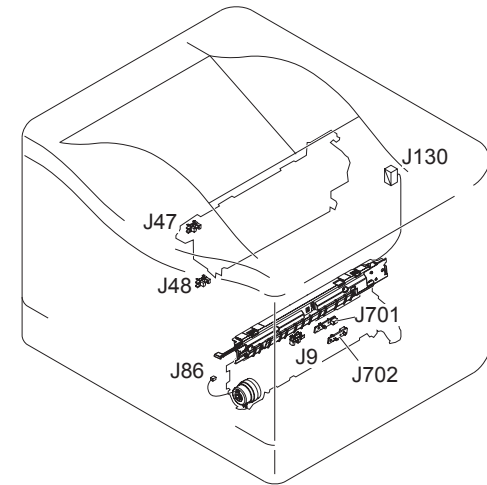
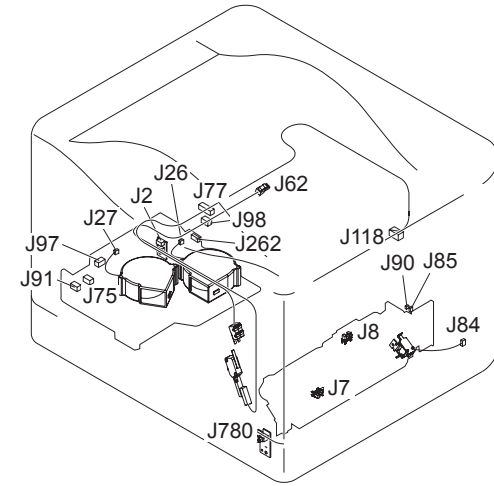

F-5-36

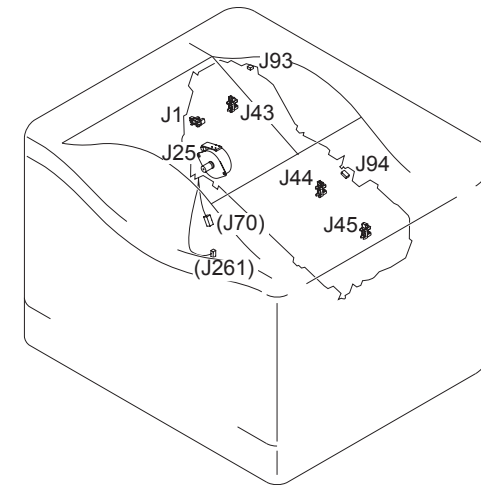
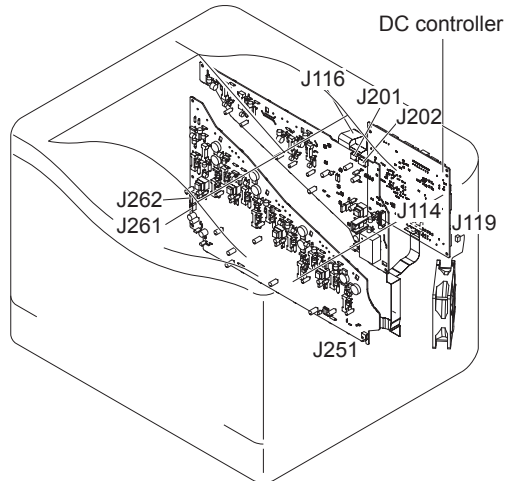
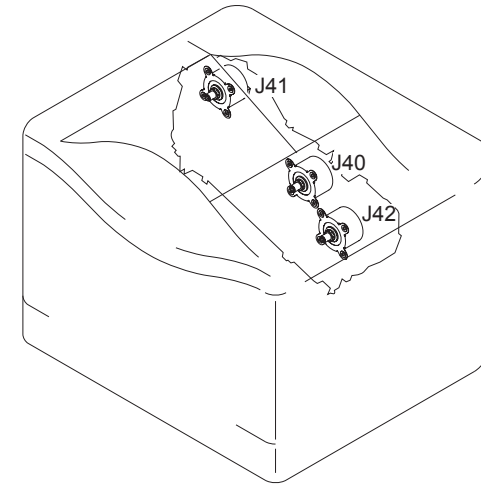
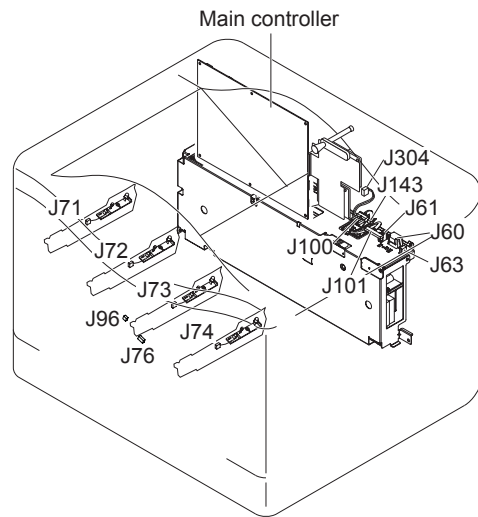

F-5-37

F-5-38

Connector List(LBP7780C/LBP5480)

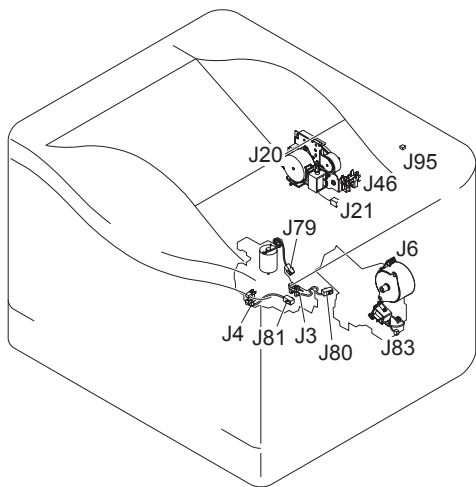
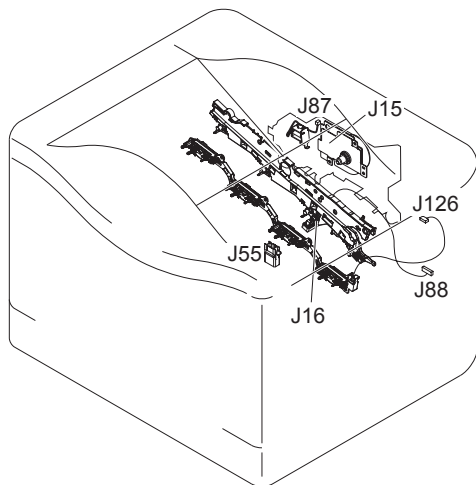

F-5-39

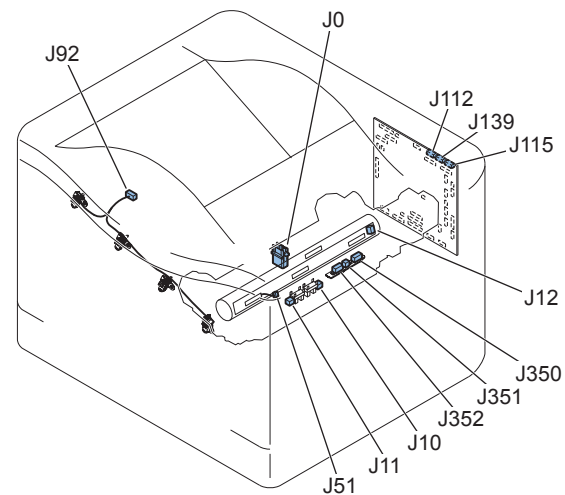
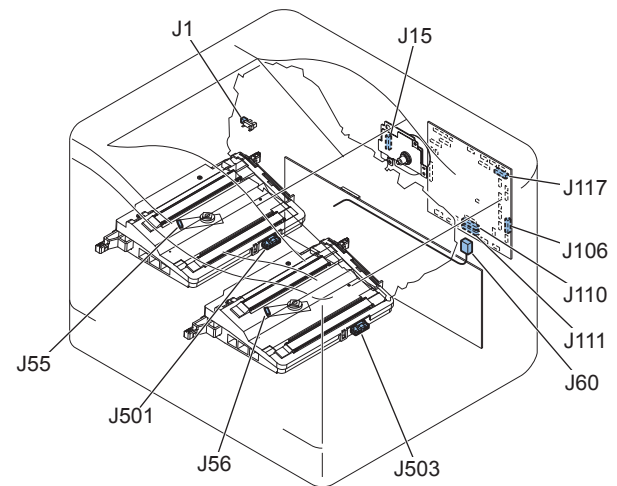

F-5-40

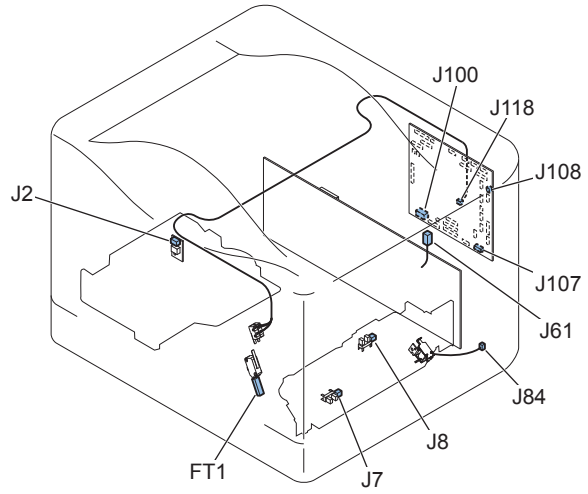

F-5-41

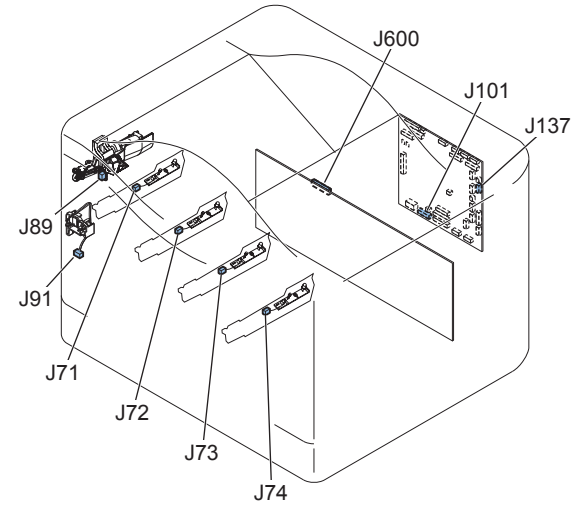

F-5-42

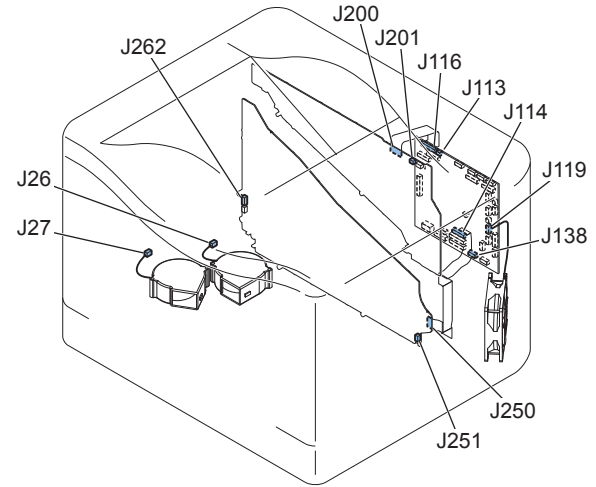
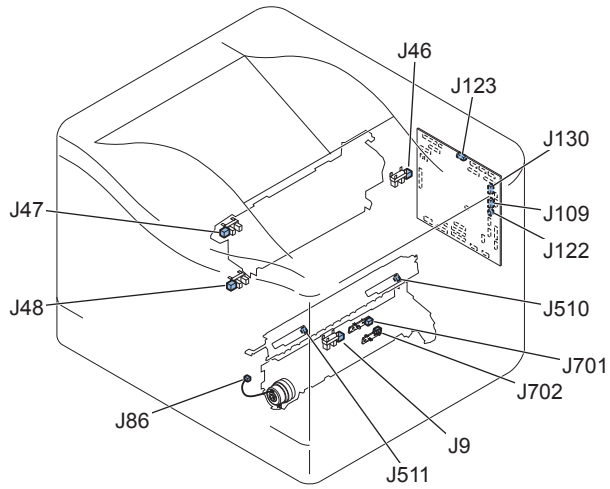

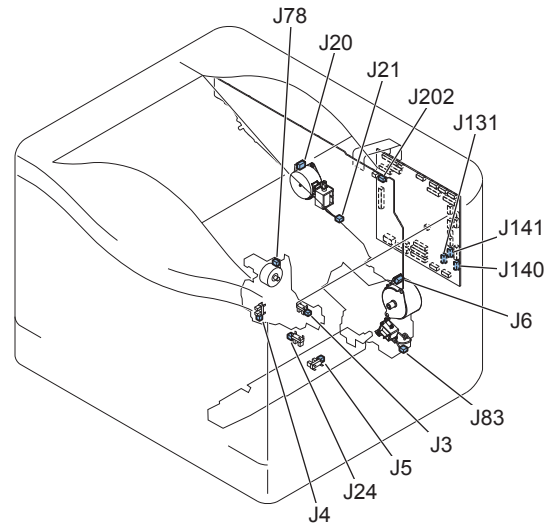
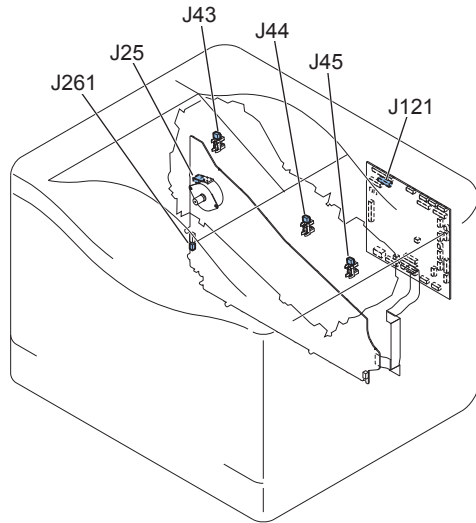
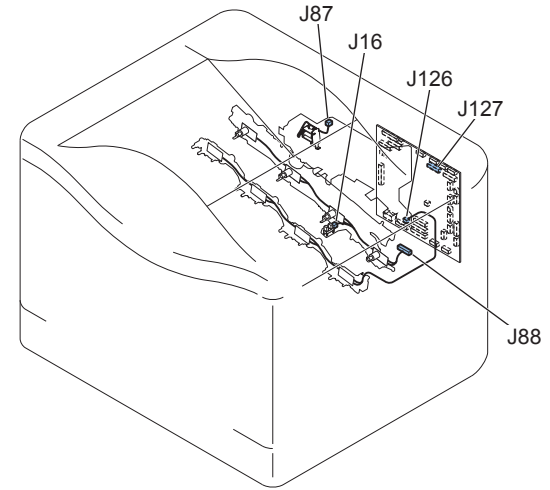
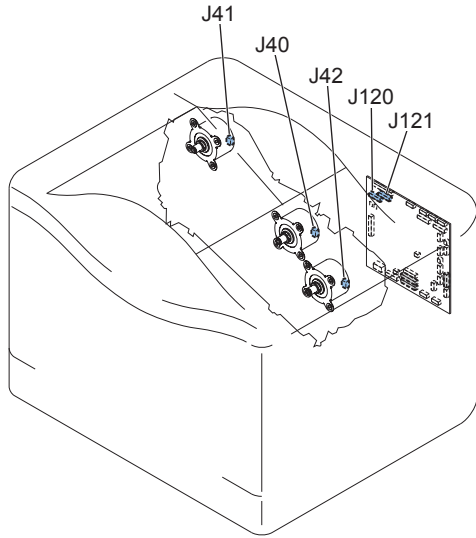

F-5-43

F-5-44

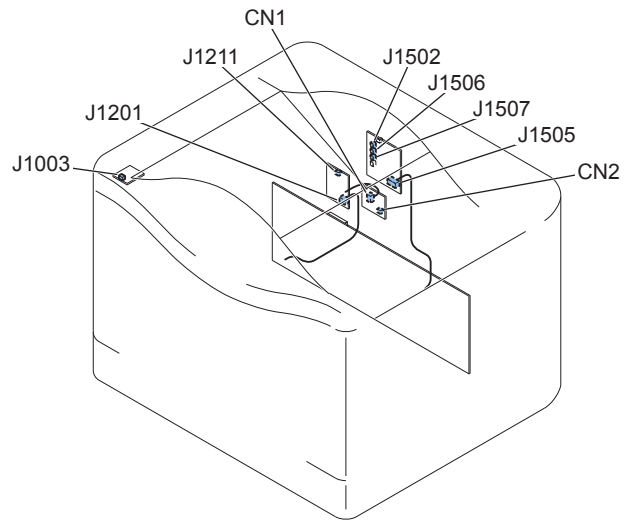
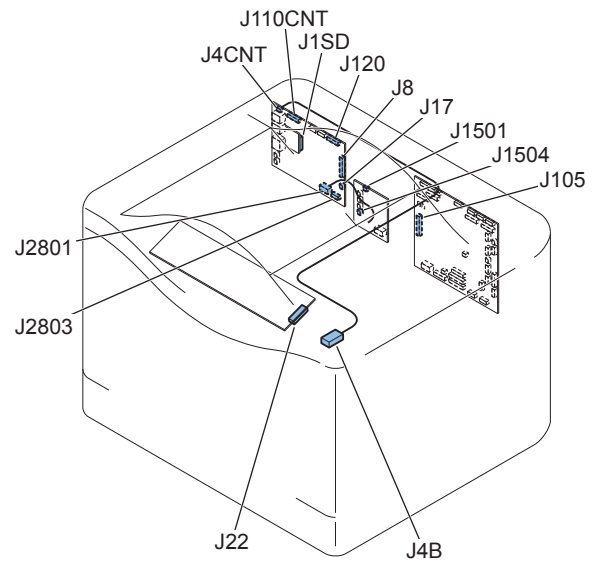

F-5-45

Service Tools

Standard Tools

No.	Tool name	Tool No.	Purpose/Remarks
1	Tool bag	TKN-0001	With a clip
2	Jumper line	TKN-0069	0.02 to 0.3mm
3	Gap gauge	CK-0057	For checking the spring pressure of the cassette: 0 to 600g
4	Spring measure	CK-0058	M4, M5 length: 363mm
5	Phillips screwdriver	CK-0101	
6	Phillips screwdriver	CK-0104	M3, M4 length: 155mm
7	Phillips screwdriver	CK-0105	M4, M5 length: 191mm
8	Phillips screwdriver	CK-0106	M4, M5 length: 85mm
9	Flat blade screwdriver	CK-0111	
10	Flat blade screwdriver set for clocks	CK-0114	A set of 6 screwdrivers
11	Hex key wrench set	CK-0151	A set of 6 wrenches
12	Smooth file	CK-0161	
13	Hex screwdriver	CK-0170	M4 length: 107mm
14	Nipper	CK-0201	
15	Long nose pliers	CK-0202	
16	Pliers	CK-0203	For the shaft ring
17	Stop ring pliers	CK-0205	
18	Crimp pliers	CK-0218	
19	Tweezers	CK-0302	For measurement, 150mm
20	Scale	CK-0303	
21	Soldering copper	CK-0309	100V, 30W
22	Plastic hammer	CK-0314	
23	Brush	CK-0315	
24	Penlight	CK-0327	
25	Plastic bottle	CK-0328	100cc
26	Solder	CK-0329	φ1.5 (mm) x 1 (mm)
27	Desoldering line	CK-0330	1.5mm
28	Lint-free paper	CK-0336	500SH/PKG
29	Oil charger	CK-0349	30cc
30	Plastic bottle	CK-0351	30cc
31	Digital multi-meter	FY9-2032	

T-5-34

Special Tools

No.	Tool name	Tool No.	Purpose/Remarks
1	Expansion ROM for servicing	FM0-2725	• Backup/Restoration by Expansion ROM for servicing and Sublog Board
2	Sublog Board	FM0-1774	• Backup/Restoration by Expansion ROM for servicing and Sublog Board • Collecting Debug Log

List of Solvents/Greases

No.	Name	Purpose	Remarks
1	Alcohol	Cleaning e.g. Plastic (Note) Rubbers Metal parts Greasy dirt Toner dirt	• Do not put it near fire. • Purchase it at the site.

T-5-35

Caution :

Clean the external cover with a firmly wrung moistened cloth.

Error Code

Error Code Details

Code	Detection details	Action
E000	Fixing startup failure	
0000	The detection temperature of the main thermistor did not increase after start of the power distribution to the heater.	<ul style="list-style-type: none"> Replace the fixing assembly. Replace the DC controller PCB.
E001	Abnormal high temperature in fixing	
0000	The main thermistor detected a temperature of higher than 255 degree C.	<ul style="list-style-type: none"> Replace the fixing assembly. Replace the DC controller PCB.
0001	The sub thermistor detected a temperature of higher than 290 degree C.	<ul style="list-style-type: none"> Replace the fixing assembly. Replace the DC controller PCB.
0004	The sub thermistor 2 detected a temperature exceeding a specified temperature.	<ul style="list-style-type: none"> Replace the fixing assembly. Replace the DC controller PCB.
E003	Abnormal low temperature in fixing	
0000	The main thermistor detected a temperature of lower than 120 degree C for more than 1 second when 20 seconds elapsed after start of the power distribution to the heater.	<ul style="list-style-type: none"> Replace the fixing assembly. Replace the DC controller PCB.
0001	The sub thermistor detected a temperature of lower than 80 degree C for more than 2 seconds when 20 seconds elapsed after start of the power distribution to the heater.	<ul style="list-style-type: none"> Replace the fixing assembly. Replace the DC controller PCB.
0004	The sub thermistor 2 detected a temperature lower than a specified temperature.	<ul style="list-style-type: none"> Replace the fixing assembly. Replace the DC controller PCB.
E004	Fixing assembly drive circuit failure	
0000	43 to 57Hz could not be detected continuously for more than 5 seconds when zero cross detection started.	<ul style="list-style-type: none"> Check the contact of the connector between the fixing assembly and the low-voltage power supply PCB. Replace the low-voltage power supply PCB.
E012	ITB motor or drum motor failure	
0002	Yellow drum motor error (Failure in drum motor initial operation) The target speed was not reached within a specified time after startup of the motor.	<ul style="list-style-type: none"> Check the contact of the connector between the drum motor (J515) and the DC controller PCB (J81). Replace the drum motor. Replace the main drive assembly.

Code	Detection details	Action
E012 0003	Yellow drum motor error (Failure in drum motor rotation) The motor rotated out of the target speed during rotation after the target speed was reached.	<ul style="list-style-type: none"> Check the contact of the connector between the drum motor (J515) and the DC controller PCB (J81). Replace the drum motor. Replace the main drive assembly.
0004	Magenta drum motor error (Failure in drum motor initial operation) The target speed was not reached within a specified time after startup of the motor.	<ul style="list-style-type: none"> Check the contact of the connector between the drum motor (J515) and the DC controller PCB (J81). Replace the drum motor. Replace the main drive assembly.
0005	Magenta drum motor error (Failure in drum motor rotation) The motor rotated out of the target speed during rotation after the target speed was reached.	<ul style="list-style-type: none"> Check the contact of the connector between the drum motor (J515) and the DC controller PCB (J81). Replace the drum motor. Replace the main drive assembly.
0006	Cyan drum motor error (Failure in drum motor initial operation) The target speed was not reached within a specified time after startup of the motor.	<ul style="list-style-type: none"> Check the contact of the connector between the drum motor (J515) and the DC controller PCB (J81). Replace the drum motor. Replace the main drive assembly.
0007	Cyan drum motor error (Failure in drum motor rotation) The motor rotated out of the target speed during rotation after the target speed was reached.	<ul style="list-style-type: none"> Check the contact of the connector between the drum motor (J515) and the DC controller PCB (J81). Replace the drum motor. Replace the main drive assembly.
0008	Black drum motor error (Failure in drum motor initial operation) The target speed was not reached within a specified time after startup of the motor.	<ul style="list-style-type: none"> Check the contact of the connector between the drum motor (J515) and the DC controller PCB (J81). Replace the drum motor. Replace the main drive assembly.
0009	Black drum motor error (Failure in drum motor rotation) The motor rotated out of the target speed during rotation after the target speed was reached.	<ul style="list-style-type: none"> Check the contact of the connector between the drum motor (J515) and the DC controller PCB (J81). Replace the drum motor. Replace the main drive assembly.
E013	Residual toner feed motor failure	
0000	Residual toner feed motor failure	<ul style="list-style-type: none"> Check the contact of the connector between the Residual toner feed motor (J89L) and the DC controller PCB (J137). Replace the Residual toner feed motor
E014	Fixing motor failure	

Code	Detection details	Action
0000	Fixing motor startup error The target speed was not reached within a specified time after startup of the motor.	<ul style="list-style-type: none"> • Check the contact of the connector between the fixing motor (J516) and the DC controller PCB (J81). • Check the gear between the fixing motor and the fixing assembly. • Replace the fixing motor.
E014 0001	Fixing motor rotation error The motor rotated out of the target speed during rotation after the target speed was reached.	<ul style="list-style-type: none"> • Check the contact of the connector between the fixing motor (J516) and the DC controller PCB (J81). • Check the gear between the fixing motor and the fixing assembly. • Replace the fixing motor.
E015	Error in the developing disengagement movement	
0000	Developing disengagement motor failure <ul style="list-style-type: none"> • The standard flag was not detected even when driving was performed for 1000ms after rotation of the motor. • The standard flag was not detected even when driving was performed for 8000ms at the time of switching from the full-color position to "all disengagement". • The standard flag was not detected even when driving was performed for 3000ms at the time of switching from the monochrome position to "all disengagement". 	<ul style="list-style-type: none"> • Reconnect the connector J518 of the developing disengagement motor, the connector J1005 on the driver PCB, and the connector J91 on the DC controller PCB. • Check the condition of the developing disengagement sensor in the sensor monitor mode. If a failure is found, replace the developing disengagement sensor assembly. • Execute the developing assembly engagement/disengagement drive test in the actuator drive mode. If the developing assembly does not perform engagement/disengagement, replace the developing disengagement motor.
0001	Cassette 1 lift up motor error	<ul style="list-style-type: none"> • Reconnect the connector J151 on the DC controller PCB and the relay connector J742. • Check the cassette media stack surface sensor in the sensor monitor mode. If a failure is found, replace the lifter drive unit. • Replace the lifter drive unit.

Code	Detection details	Action
0002	Cassette 2 lift up motor error	<ul style="list-style-type: none"> • Reconnect the connector J2003 on the paper feeder driver PCB and the relay connector J702. • Check the paper feeder media stack surface sensor in the sensor monitor mode. If a failure is found, replace the pickup unit. • Reconnect the connector J2006 on the paper feeder driver PCB. • Replace the lifter drive unit.
E020	Error in density sensor	
0000	Density sensor failure warning	
E066	Error in the environment sensor	
0000	Environment sensor failure	Replace the environment sensor.
E06F	EEPROM access error	
0068	EEPROM access failure	Replace the EEPROM.
E078	Error in primary transfer disengagement.	
0001	Primary transfer disengagement mechanism failure <ul style="list-style-type: none"> • At the time of searching the home position: Considering that the coupling of primary transfer engagement/disengagement drive may not be connected, the solenoid was pulled for maximum 6 times in the condition where the flag was detected once. But the HP sensor did not detect the color print engagement position. * If a flag is not detected even once, it is considered that the ITB unit is absent. • At the time of changing the position The position after turning ON/OFF of the solenoid did not match the HP sensor value. 	<ul style="list-style-type: none"> • Check whether the ITB unit is installed or not. • Reconnect the connector J181 on the DC controller PCB. • Check the primary transfer roller disengagement switch in the sensor monitor mode. If a failure is found, replace the primary transfer roller disengagement switch assembly. • Execute the primary transfer roller engagement/disengagement drive test in the actuator drive mode. If the primary transfer roller does not perform engagement/disengagement, replace the fixing drive unit.
E100	Optical assembly error (Laser)	
0000	Yellow optical assembly failure	<ul style="list-style-type: none"> • Check the contact of the connector between the laser scanner unit and the DC controller. • Replace the laser scanner unit.
0001	Magenta optical assembly failure	
0002	Cyan optical assembly failure	
0003	Black optical assembly failure	
0004	Optical assembly error (Laser failure)	
E110	Optical assembly error (Scanner motor)	

Code	Detection details	Action
0000	Optical assembly error (Scanner motor initial operation failure)	<ul style="list-style-type: none"> Check the contact of the connector between the laser scanner unit and the DC controller. Replace the laser scanner unit.
0001	Optical assembly error (Scanner motor rotation failure)	
E196	Invalid RFU execution requested	
0000	D-con update for the host machine or the optional cassette is not completed.	Replace the DC controller PCB
0001	D-con update for the optional cassette is not completed.	Replace the DC controller PCB
E197	Engine FN Error	
0002	Error in DC Controller software	<ol style="list-style-type: none"> Turn OFF and then ON the power. Download the Dcon firmware again by Updater. Replace the DC controller PCB

Code	Detection details	Action
E198	DC controller memory failure	
0000	<ul style="list-style-type: none"> A checksum failure is found in the block where specific information of the DC controller PCB is saved. A communication error occurred when reading the specific information of the DC controller PCB from the NVRAM at power-on. 	If the failure cannot be removed by turning the power OFF/ON, replace the DC controller PCB.
E245	• System Error	
1xxx		Contact the sales companies.
2xxx		Contact the sales companies.
E246	• System Error	
xxxx		Contact the sales companies.
E247	• System Error	
xxxx		Contact the sales companies.
E350	• System Error	
xxxx		Contact the sales companies.
E354	• System Error	
xxxx		Contact the sales companies.
E355	• System Error	
xxxx		Contact the sales companies.
E602	HDD error, Error in Main Controller memory	
0001	Lack of the HDD capacity The capacity of the HDD installed is smaller than that of the HDD used in the software.	Turn on the power again.
0002	Bootable load failure A Bootable CD was not contained. A Bootable CD was damaged.	Burn the Bootable CD again.
0003	HDD access error An error occurred caused by the device or hardware when accessing to the HDD during execution of bootrom. (Damage to the sector / Busy device status, etc.)	Turn on the power again.
0006	SubBootable load failure A SubBootable CD was not contained. A SubBootable CD was damaged.	Burn the SubBootable CD again.
0007	The contents (ICC-Profile, etc.) could not be detected. (The contents were not contained. The contents were damaged, etc.)	Burn the Bootable CD again.

Code	Detection details	Action
0008		
0009		
1102	Error detection of file system	Execute the following procedures. 1. Turn OFF and then ON the power. 2. Download the /APL_CDS firmware again by Updater. If E616-0001 occurs at restart after turning OFF and then ON the power, execute the following procedures. 1. Initialize MEAP area, and install MEAP application again. (Refer to the remedy for E616-0001.) 2. Download the /APL_CDS firmware again by Updater.
1112	Device access error	Execute the following procedures. If E616-0001 occurs after turning OFF and then ON the power (procedure 1), install MEAP application again by following the remedy for E616-0001 first. Then, execute the procedure 2. 1. Turn OFF and then ON the power. 2. Download the /APL_CDS firmware again by Updater
1113	Device access error	Execute the following procedures. If E616-0001 occurs after turning OFF and then ON the power (procedure 1), install MEAP application again by following the remedy for E616-0001 first. Then, execute the procedure 2. 1. Turn OFF and then ON the power. 2. Download the /APL_CDS firmware again by Updater.
1302	File system initialization error	Execute the following procedures. 1. Turn OFF and then ON the power. 2. Download the /APL_CDS firmware again by Updater.
1312	Device access error	Execute the following procedures. 1. Turn OFF and then ON the power. 2. Download the /APL_CDS firmware again by Updater.
1313	Device access error	Execute the following procedures. 1. Turn OFF and then ON the power. 2. Download the /APL_CDS firmware again by Updater.

Code	Detection details	Action
1602	File system initialization error	Execute the following procedures. 1. Turn OFF and then ON the power. 2. Download the /APL_CDS firmware again by Updater.
1612	Device access error	Execute the following procedures. 1. Turn OFF and then ON the power. 2. Download the /APL_CDS firmware again by Updater.
1613	Device access error	Execute the following procedures. 1. Turn OFF and then ON the power. 2. Download the /APL_CDS firmware again by Updater.
E604	Memory error	
0000	Lack of memory capacity	- Remove and then install the additional memory.
0001	Failed to allocate the memory required to start PDL.	- Replace the additional memory with a correct one. - Turn OFF and then ON the power. - Replace the Controller PCB.
E616	Error in MEAP application	
0001	MEAP application was deleted by auto recovery at restart after E602-11XX.	Initialize MEAP area in the flash memory with the following procedures, and install MEAP application again. 1. Initialize the MEAP area. Service Mode > FUNCTION GR. > MEAP > MEAP FUNCTION > ON 2. Install MEAP application again.
0002		
E730	Printer service call	
100A	Printer service call	Turn on the power again.
C000	An error such as memory not acquired at initialization occurred.	Turn on the power again.
C001	An error occurred when accessing the HDD.	Turn on the power again.
D000	An error, such as failure in memory retrieval at initialization, occurred.	- Turn OFF and then ON the power. - Replace the Main Controller PCB.
D001	Printer communication error (communication error at initial communication and negotiation packet error)	- Turn OFF and then ON the power. - Replace the Main Controller PCB.
E733	Printer communication error	

Code	Detection details	Action
0001	Printer communication error (Invalid communication after communication is established, Parity error)	<ul style="list-style-type: none"> • Turn on the power again. • Replace the DC controller PCB.
0004	Printer communication error (Undefined command error)	<ul style="list-style-type: none"> • Turn on the power again. • Replace the DC controller PCB.
0005	Printer communication error (Communication timeout error)	<ul style="list-style-type: none"> • Turn on the power again. • Replace the DC controller PCB.
0006	Printer communication error (Unknown communication error)	<ul style="list-style-type: none"> • Turn on the power again. • Replace the DC controller PCB.
E740	Invalid MAC address detection	
0002	An invalid MAC address was detected.	<ol style="list-style-type: none"> 1.Check the contents of the MAC address. 2.Write a MAC address. 3.Replace the board.
0004	LAN controller chip access error	<ol style="list-style-type: none"> 1.Check the area around the LAN chip. 2.Replace the board.
E744	Model code mismatch	
0800	Model code mismatch	Replace Soft-ID PCB.
0900	Model code mismatch	Change to proper bootable.
1000	Mismatch of the series or model of the firmware sent at the time of downloading	Check the supported series or model of the firmware, and burn the correct series or model of firmware.
1100	Detection of falsification of the Controller Board	<ul style="list-style-type: none"> - Turn OFF and then ON the power. - Replace the Main Controller PCB.
E748	Error in Main Controller	
2012	Failed to rewrite due to no more alternative block of Flash ROM (NAND) available.	-Replace the Main Controller PCB.
4000	Timeout of G-Chip loop back	Replace the main controller PCB.
4020	Unknown device detected on the PCI	Replace the main controller PCB.
E760	CPU Processing Error	
0000	CPU exception occurred.	Turn on the power again.
E804	Fan failure	
0000	Power supply fan failure	<ul style="list-style-type: none"> • Check the connection of the connector. • Replace the fan. • Check the harness (check for disconnected/pinched harness)
E805	Fan failure	

Code	Detection details	Action
0003	Controller fan failure detected The controller fan does not rotate because some kind of failure occurred in it.	Replace the controller fan.
E805	Fan failure	
0006	Power supply fan failure The fan did not rotate even when 12 seconds elapsed after the motor rotation start order was received.	<ul style="list-style-type: none"> • Reconnect the connector J21 on the DC controller PCB and the connector J106 on the low-voltage power supply unit. • If the voltage between the connectors J21-2 and J25-2 on the DC controller PCB is changed from 0V to approximately 24V immediately after the printer is turned on, replace the power supply fan.
E806		
0001	Delivery fan error	<ul style="list-style-type: none"> • Check the connection of the connector. • Replace the fan. • Check the harness (check for disconnected/pinched harness)
E808	Error in low voltage power supply	
0001	Low-voltage power supply failure	Replace the Low-voltage power supply unit.
E825	Drum phase control sensor failure warning	
0000	Yellow drum phase control sensor failure warning <ul style="list-style-type: none"> • A slit was not detected for 4 seconds after slit detection started. • An abnormal slit width was detected. 	<ul style="list-style-type: none"> • Check the YMC drum drive gear. • Replace the YMC drum HP sensor (PS13).
0001	Magenta drum phase control sensor failure warning <ul style="list-style-type: none"> • A slit was not detected for 4 seconds after slit detection started. • An abnormal slit width was detected. 	
0002	Cyan drum phase control sensor failure warning <ul style="list-style-type: none"> • A slit was not detected for 4 seconds after slit detection started. • An abnormal slit width was detected. 	
0003	Black drum phase control sensor failure warning <ul style="list-style-type: none"> • A slit was not detected for 4 seconds after slit detection started. • An abnormal slit width was detected. 	<ul style="list-style-type: none"> • Check the Bk drum drive gear. • Replace the Bk drum HP sensor (PS12).

Code	Detection details	Action
0004	OHT sensor failure warning	-
E840	Pressure release mechanism failure	
0000	The target pressure position was not reached even when 3.5 seconds (approximately 1.5 rotation of the cam) elapsed after start of the fixing motor reverse rotation.	<ul style="list-style-type: none"> • Check the gears and detection flags related to fixing pressure release mechanism. • Replace the fixing pressure release sensor (PS9). • Replace the fixing motor. • Replace the fixing assembly.

T-5-36

Jam Code

Jam code		Cause	Jammed paper position
Upper digits	Lower digits		
84		Pickup delay jam 1	
85		Pickup delay jam 2	
88		Pickup stationary jam 1	
8A		Pickup stationary jam 3	
8C		Fixing delivery delay jam 1	
90		Fixing delivery stationary jam 1	
94		Residual paper jam 1	
98		Door open jam 1	
9C		Wrapping jam 1	
A4		Duplex re-pickup assembly jam 1	
A5		Duplex re-pickup assembly jam 2	
	00		Unknown area
	01		Area between the pickup slot 1 and the registration position
	02		Area between the pickup slot 2 and the registration position
	03		Area between the pickup slot 3 and the registration position
	07		Area between the registration position and the cartridge
	08		Area between the cartridge and the fixing roller
	09		Area between the fixing roller and the delivery assembly
	0C		Duplex reverse assembly neighborhood area
	0E		Duplex re-pickup assembly neighborhood area

T-5-37

Alarm Code

Location code/ Location		Alarm code/ Description			LEVEL	Remarks
EE		FFFF				
05	Transfer System, Copier	0001				LBP7780C/ LBP5480 not supported
06	Fixing System, Copier	0002	Fixing upper roller alarm	Fixing upper roller alarm	3	
11	Drum Cleaner System, Copier Waste Toner Collecting system	0001	Waste toner box full (transfer belt)	Waste toner box full (transfer belt)	3	

T-5-38

Version Up

Overview

Overview of Upgrading

Upgrading is performed by downloading firmware from a personal computer (hereinafter called PC) to this machine using a user support tool (hereinafter called UST).

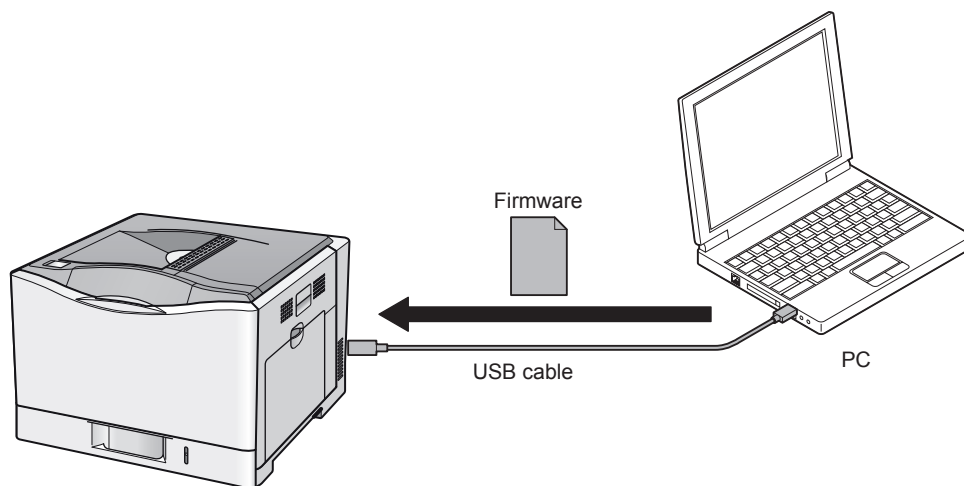

F-5-46

Preparation

Necessary System Environment

- OS (Any of the following)
 - Microsoft Windows 2000 Server/Professional Japanese Edition
 - Microsoft Windows XP Professional/Home Edition Japanese Edition*
 - Microsoft Windows Server 2003 Japanese Edition*
 - Microsoft Windows Vista Japanese Edition*
 - * : 32-bit processor version only
 - Microsoft Windows 7
- PC
 - The OS listed above operates.
 - Memory (RAM): 32MB or greater
 - Hard disk: 100MB or greater
 - Display: Resolution 640 x 480 pixel or greater, 256-color or greater
 - Equipped with USB port
- UST file* of this machine
 - * : Download the file from a system CD or website. (It differs depending on the sales company.)
- USB cable (USB1.1/2.0)

Firmware Configuration

Firmware	Function	Storage area
BOOTROM	Startup of the main controller	Main controller PCB
BOOTABLE	Overall control	Main controller PCB
LANGUAGE	Language file	Main controller PCB
DCON	Control of the printer	DC controller PCB

T-5-39

A number of firmware may be less than the above depending on the UST version.

■ Before Downloading the System Software

- 1) Start up the PC.
- 2) Connect the host machine and the PC with a USB cable.
- 3) Turn on the host machine, and place it in the standby status.
- 4) Place the machine in the off-line status by pressing the Off-line key, and select Firmware Upgrading in the user mode.
Setup > User maintenance > Firmware upgrading
- 5) When pressing the OK key, the host machine automatically restarts up, and "UPDATEMODE READY" is displayed in the display. (The On-line lamp flashes.)

MEMO :

Once the machine enters the upgrading mode, normal operation cannot be performed until upgrading is completed. To discontinue upgrading, turn the power OFF/ON.

● Downloading the System Software

■ Downloading the System

● Procedure of Downloading

- 1) Open UST (UST_UPDATE_LBP7750C_5460PM_XXXX.exe).
XXXX: Firmware version

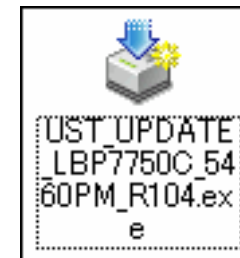

F-5-47

- 2) Write down the firmware version to upgrade, and click the "Next" button.

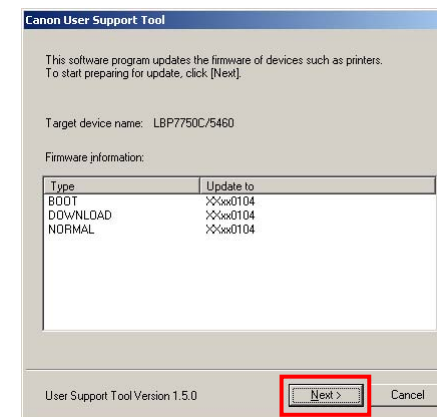

F-5-48

3) Click the "Next" button.

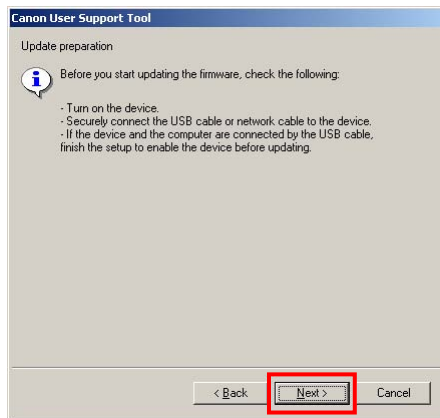

F-5-49

4) Select the USB connection device, and click the "Next" button.

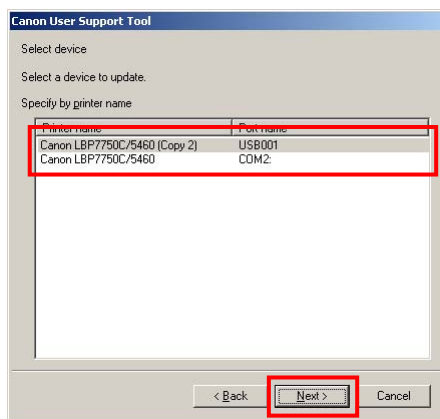

F-5-50

5) Click the "Start" button.

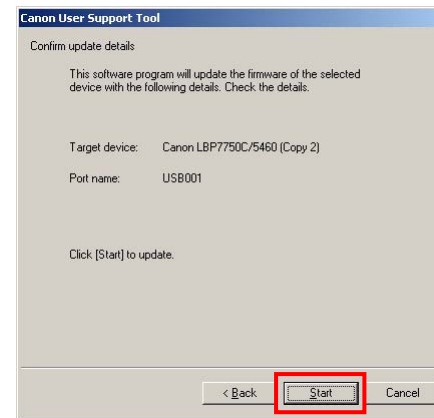

F-5-51

6) When the warning screen is displayed, click the "Yes" button.

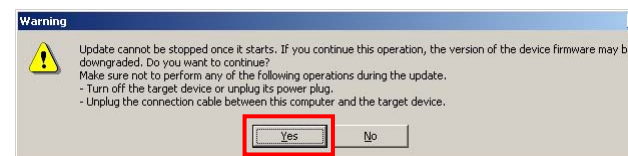

F-5-52



F-5-53

MEMO :
 "DOWNLOADING XX%" and "UPDATING XX%" are displayed in the display of the host machine during downloading. (XX shows the progress degree.)

7) When downloading is completed, click the "OK" button.

The host machine automatically restarts up.

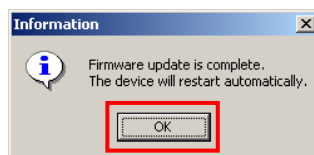

F-5-54

8) Perform common status print via the user mode, and make sure that the firmware version matches the information written down in Procedure 2).

Utility > Common status print

Service Mode

Service Mode List(LBP7750C/LBP5460)

COUNTER GR.

Item	Description	Setting range
INIT.FIX.COUNT	Initialize the counter value of the fixing assembly.	----
INIT.ITB UNIT	Initialize the counter value of the ITB unit.	----
INIT.REG-ROLL	Initialize the counter value of the registration roller.	----

T-5-40

ADJUST GR.

Item	Description	Setting range
CALIBRATION	Execute calibration.	ON / OFF
CHARGE BIAS Y	Change the primary charging bias value for yellow.	-5 to 0 to 5
CHARGE BIAS M	Change the primary charging bias value for magenta.	-5 to 0 to 5
CHARGE BIAS C	Change the primary charging bias value for cyan.	-5 to 0 to 5
CHARGE BIAS K	Change the primary charging bias value for black.	-5 to 0 to 5
DEV BIAS Y	Change the developing bias value for yellow.	-5 to 0 to 5
DEV BIAS M	Change the developing bias value for magenta.	-5 to 0 to 5
DEV BIAS C	Change the developing bias value for cyan.	-5 to 0 to 5
DEV BIAS K	Change the developing bias value for black.	-5 to 0 to 5
FRT FUSE TEMP	Change the fixing temperature on the front side.	-4 to 0 to 4
BCK FUSE TEMP	Change the fixing temperature on the backside at duplex printing.	-4 to 0 to 4
T1 ATVC BIAS Y	Change the primary transfer ATVC value for yellow.	-5 to 0 to 5
T1 ATVC BIAS M	Change the primary transfer ATVC value for magenta.	-5 to 0 to 5
T1 ATVC BIAS C	Change the primary transfer ATVC value for cyan.	-5 to 0 to 5
T1 ATVC BIAS K	Change the primary transfer ATVC value for black.	-5 to 0 to 5
T2 ATVC BIAS F	Change the secondary transfer ATVC value on the front side.	-5 to 0 to 5
T2 ATVC BIAS B	Change the secondary transfer ATVC value on the backside at duplex printing.	-5 to 0 to 5
REG INFO CLEAR	Clear the color registration information.	----

T-5-41

OPTION GR.

Item	Description	Setting range
B4-L-CNT	Set to determine B4 size to be large size or small size. • ON: B4 size is to be large size. • OFF: B4 size is to be small size.	ON / OFF
SCT-ALL-CLR	Set to determine whether "Clear All Counts" can be executed from "Department ID Management" screen on RUI. • ON: "Clear All Counts" can be executed. • OFF: "Clear All Counts" cannot be executed.	ON / OFF
SCT-IDV-CLR	Set to determine whether "Clear Count" can be executed from "Edit Department" screen on RUI. • ON: "Clear Count" can be executed. • OFF: "Clear Count" cannot be executed.	ON / OFF
PS-MODE	Set for the EFI compatibility at PS duplex delivery and the function to change the Stroke Adjustment default value. • Bit 7: When the setting is ON, the conversion curve line for Type 3 dither is reversed (embossed arch line). • Bit 6: When the setting is ON, 16 × 16 size dither (used for BW2) is used. • Bit 5: When the setting is ON, duplex print of the same paper size with Portrait and Landscape mixed is performed. • Bit 4: When the setting is ON, the default value of Stroke Adjustment is to be TRUE. By doing so, uneven line width based on the coordinates can be changed to even line width.	0 to 65535 (increment by 1)
COUNTER-SW *1	Set the counter switch. • MODEL1: Setting value 1 • MODEL2: Setting value 2.	MODEL1 / MODEL2

*1:Supporting the North America models with the charge counter only

T-5-42

FUNCTION GR.

Item	Description		Setting range
ECONF	EXPORT	Export the device setting data.	GENERAL/ DEPEND/ SECURITY/ALL
	IMPORT	Import the device setting data.	----
USB-H	Set the USB host function.		ON / OFF [*]
SUBLOG TO USB	Output a sub log to the USB memory.		----
RESTORE DCON	Rewrite the backup data of the DC controller saved in the EPROM of the main controller to the EPROM of the DC controller		----
CLEAR DCON	Initialize the backup data of the EPROM of the DC controller.		----
COLOR MODE SLCT	Set whether to make a judgment of color/monochrome printing at the printer side.		ON / OFF [*]
SHIPLOCK	Set detachment of cartridge drum (software lock) After releasing the hardware lock and turning ON the power switch, the software lock can be also released. If only one lock (hardware or software) is released, this may cause coming off the part called drum blade. <ul style="list-style-type: none"> MODE 1: Until the setting is changed to MODE 2, the state of lock remains. MODE 2: When the power switch is turned ON next time, the software lock is released. 		MODE 1 / MODE 2 [*]

T-5-43

LOG GR.

Item	Description	Setting range
SYSTEM LOG	Make a setting of the system log function.	ON [*] / OFF
SUBLOG FTP GET	Sub log is collected without using the serial consol.	----
LOGGING UTILITY	Set to determine whether "Logging Utility" function in the utility menu is used. <ul style="list-style-type: none"> ON: "Logging Utility" function is used. OFF: "Logging Utility" function is not used. 	ON / OFF [*]
DEBUGLOG-SW	Set to determine whether the sub log is automatically output when E code, Exception or Service Call occurs. <ul style="list-style-type: none"> ON: Sub log is automatically output. OFF: Sub log is not automatically output. <p>Basic procedure:</p> <ul style="list-style-type: none"> In case that user sets manually from LUI: <ol style="list-style-type: none"> 1) Insert the USB memory by user. 2) Set the service switch "USB-H" to ON by user. 3) Set the service switch "DEBUGLOG-SW" to ON by user. 4) After an error occurs, record the debug log to USB memory from the menu (LUI) by user. 5) Perform the shutdown processing, and turn OFF and ON the main power switch of the machine by user. In case of remote setting from RDS: <ol style="list-style-type: none"> 1) Insert the USB memory by user. 2) From RDS, set the service switch "DEBUGLOG-SW" to ON by service technician. 3) After an error occurs, the debug log is automatically recorded to USB memory. 4) Perform the shutdown processing, and turn OFF and ON the main power switch of the machine by service technician. 	ON / OFF [*]

T-5-44

F/W UPDATE GR.

Item	Description	Setting range
USB	Execute upgrading of the controller firmware. (Only USB is supported.)	----
NETWORK	Execute upgrading of the controller firmware.	----

T-5-45

NETWORK GR.

Item	Description	Setting range
DNSTRANS	Set to determine the priority order of protocol (IPv4/IPv6) to be used for DNS inquiry.	IP V. 4/IP V. 6 [*]
FTP SYSLOG	Make a setting of the various system log file acquisition function.	ON / OFF [*]
JOB SERIALIZE	Make a setting of the connection realize function.	ON / OFF [*]
BUFFER LIMIT	PSS buffer collection limit is cleared.	ON / OFF [*]
E-RDS SWITCH	Set to determine whether Embedded-RDS is used. • ON: Embedded-RDS is used. • OFF: Embedded-RDS is not used.	ON / OFF [*]
RGW-ADDRESS	URL can be checked and set here. For the URL entry, use various keys (up/down/left/right keys, Job Status/Cancel key and Feeder Selection key). Then, press OK key to set the entry. In the very end of character strings, "down-pointing arrow" is displayed. Up to 128 characters can be entered.	----
RGW-PORT	Set the port number of server.	1 to 443 [*] to 65535
COM-TEST	Communication test is executed. The machine tries to connect to the server, judges whether it was connected, and displays the result.	----
COM-LOG	Details of communication test result are displayed. When any error occurs, the time, error code and error information are displayed. Up to 5 logs can be stored and the latest log is displayed.	----
CLEAR	Beside e-RDS setting value in the service mode, schedule information, alarm and filtering information are cleared.	----
CA-KEY	CLEAR After executing this item, turn the power OFF/ON to set the CA certificate to the default status.	----
MIB CHARGECOUNT	• ALL ACCESS: All information in the charge counter MIB can be collected. • DISP ACCESS: Information displayed on LUI in the charge counter MIB is displayed. • NON ACCESS: All information in the charge counter MIB cannot be collected.	ALL ACCESS DISP ACCESS NON ACCESS

Item	Description	Setting range	
SNMP	canon_admin	<ul style="list-style-type: none"> • OFF: canon_admin community is disabled. • READ ONLY: canon_admin community is enabled. MIB access right: Read Only • READ WRITE: canon_admin community is enabled. MIB access right: Read Write 	OFF ReadOnly ReadWrite [*]
	canon_user	<ul style="list-style-type: none"> • OFF: canon_user community is disabled. • READ ONLY: canon_user community is enabled. MIB access right: Read Only • READ WRITE: canon_user community is enabled. MIB access right: Read Write 	OFF ReadOnly ReadWrite [*]
TCP DELAYED ACK	ON: TCP ACK delay function is enabled. OFF: TCP ACK delay function is disabled.	ON [*] / OFF	
WOLtrans	1: Wake Up function using the new protocol (WSD) is enabled. Wake Up function with the old utility using CPCA Echo (broadcast) packet is not provided. 2: Wake Up function using the new protocol (WSD) is enabled. Wake Up function with the old utility using SNMP search broadcast packet is not provided. 3: Wake Up function using the old Canon utility is enabled. Wake Up function with the new protocol (WSD) is not provided.	1 [*] to 3	
SLEEP ADVERTISE	SWITCH	Set to determine whether sleep notification is used.	ON [*] / OFF
	PORT	Set the port number as the address for sleep notification.	1 to 11427 [*] to 65535
	TTL	Set the number of routers which can exceed the number of sleep notification messages.	0 to 3 [*] to 254
	INTERVAL	Set the interval for sleep notification (unit: second).	60 to 600 [*] to 65535
PROXYRES	Set the proxy response function.	ON [*] / OFF	

T-5-46

■ SP.ADMIN.MODE

Item	Description	Setting range
MAINTENANCE C.	This item is displayed only when "Maintenance Code" is not set. By entering the Maintenance Code here, the menu item in the Special Administration Mode can be displayed.	----

T-5-47

● Service Mode List(LBP7780C/LBP5480)

■ COUNTER GR.

Item	Description	Setting range
INIT.FIX.COUNT	Initialize the counter value of the fixing assembly.	----
INIT.ITB UNIT	Initialize the counter value of the ITB unit.	----
INIT.REG-ROLL	Initialize the counter value of the registration roller.	----

T-5-48

■ ADJUST GR.

Item	Description	Setting range
CARIBRATION	Execute calibration.	ON / OFF
CHARGE BIAS Y	Change the primary charging bias value for yellow.	-5 to 0 to 5
CHARGE BIAS M	Change the primary charging bias value for magenta.	-5 to 0 to 5
CHARGE BIAS C	Change the primary charging bias value for cyan.	-5 to 0 to 5
CHARGE BIAS K	Change the primary charging bias value for black.	-5 to 0 to 5
DEV BIAS Y	Change the developing bias value for yellow.	-5 to 0 to 5
DEV BIAS M	Change the developing bias value for magenta.	-5 to 0 to 5
DEV BIAS C	Change the developing bias value for cyan.	-5 to 0 to 5
DEV BIAS K	Change the developing bias value for black.	-5 to 0 to 5
FRT FUSE TEMP	Change the fixing temperature on the front side.	-4 to 0 to 4
BCK FUSE TEMP	Change the fixing temperature on the backside at duplex printing.	-4 to 0 to 4
T1 ATVC BIAS Y	Change the primary transfer ATVC value for yellow.	-5 to 0 to 5
T1 ATVC BIAS M	Change the primary transfer ATVC value for magenta.	-5 to 0 to 5
T1 ATVC BIAS C	Change the primary transfer ATVC value for cyan.	-5 to 0 to 5
T1 ATVC BIAS K	Change the primary transfer ATVC value for black.	-5 to 0 to 5
T2 ATVC BIAS F	Change the secondary transfer ATVC value on the front side.	-5 to 0 to 5
T2 ATVC BIAS B	Change the secondary transfer ATVC value on the backside at duplex printing.	-5 to 0 to 5
REG INFO CLEAR	Clear the color registration information.	----

T-5-49

OPTION GR.

Item	Description	Setting range
LONG SLEEP TIME	<ul style="list-style-type: none"> To set long sleep time. 	0 to 8' to 24
B4-L-CNT	Set to determine B4 size to be large size or small size. <ul style="list-style-type: none"> ON: B4 size is to be large size. OFF: B4 size is to be small size. 	ON / OFF
SCT-ALL-CLR	Set to determine whether "Clear All Counts" can be executed from "Department ID Management" screen on RUI. <ul style="list-style-type: none"> ON: "Clear All Counts" can be executed. OFF: "Clear All Counts" cannot be executed. 	ON / OFF
SCT-IDV-CLR	Set to determine whether "Clear Count" can be executed from "Edit Department" screen on RUI. <ul style="list-style-type: none"> ON: "Clear Count" can be executed. OFF: "Clear Count" cannot be executed. 	ON / OFF
PS-MODE	Set for the EFI compatibility at PS duplex delivery and the function to change the Stroke Adjustment default value. <ul style="list-style-type: none"> Bit 7: When the setting is ON, the conversion curve line for Type 3 dither is reversed (embossed arch line). Bit 6: When the setting is ON, 16 × 16 size dither (used for BW2) is used. Bit 5: When the setting is ON, duplex print of the same paper size with Portrait and Landscape mixed is performed. Bit 4: When the setting is ON, the default value of Stroke Adjustment is to be TRUE. By doing so, uneven line width based on the coordinates can be changed to even line width. 	0 to 65535 (increment by 1)
COUNTER-SW *1	Set the counter switch. <ul style="list-style-type: none"> MODEL1: Setting value 1 MODEL2: Setting value 2. 	MODEL1 / MODEL2
CALIB IN JOB		ON / OFF
LIMIT AUTO CALIBRATE	To control whether to execute or restrain calibration when calibration of color displacement correction and density correction is requested by the engine.	ON / OFF
TONEROUT CONT.PRINT	To set to enable/disable printing when the toner reaches the end of life. The following is controlled: Whether to continue color printing when YMC toner reaches the end of life, and whether to continue all the printing when Bk toner reaches the end of life.	ON / OFF

*1:Supporting the North America models with the charge counter only

T-5-50

FUNCTION GR.

Item	Description		Setting range
ECONF	EXPORT	Export the device setting data.	GENERAL/ DEPEND/ SECURITY/ALL
	IMPORT	Import the device setting data.	----
USB-H	Set the USB host function.		ON / OFF*
SUBLOG TO USB	Output a sub log to the USB memory.		----
RESTORE DCON	Rewrite the backup data of the DC controller saved in the EPROM of the main controller to the EPROM of the DC controller		----
CLEAR DCON	Initialize the backup data of the EPROM of the DC controller.		----
COLOR MODE SLCT	Set whether to make a judgment of color/monochrome printing at the printer side.		ON / OFF*
SHIPLOCK	Set detachment of cartridge drum (software lock) After releasing the hardware lock and turning ON the power switch, the software lock can be also released. If only one lock (hardware or software) is released, this may cause coming off the part called drum blade. <ul style="list-style-type: none"> MODE 1: Until the setting is changed to MODE 2, the state of lock remains. MODE 2: When the power switch is turned ON next time, the software lock is released. 		MODE 1 / MODE 2*

Item	Description		Setting range
MEAP	MEAP-PN	To specify the port number of MEAP HTTP.	0 to 8000* to 65535
	MEAP-SSL	To specify the port number of MEAP HTTPS.	0 to 8443* to 65535
	CDS-MEAP	To set whether to permit the user administrator to install MEAP application	ON/OFF*
	CDS-FIRM	To set whether to permit the user administrator to update firmware	ON/OFF*
	CDS-UGW	To set whether to permit firmware update from UGW	ON/OFF*
	CDS-LVUP	To set whether to permit service technician or user administrator to use the periodical update function.	ON/OFF*
	CDS-CTL	To switch the country to obtain firmware in CDS.	
	MEAP-FUNCTION	MEAP recovery	ON/OFF*
	LCDSFLG	To switch whether to permit the user administrator to use the local CDS (L-CDS).	ON/OFF*
DDNSINTV	To change DDNS periodical update interval. When 0 is set, periodical update is not performed	0 to 24 ¹ to 48	
IPMTU	To change MTU size of network packet.	1 to 10 ¹	
POL Z Logic	FURUYA mode: Composition algorithm of Z (attribute information) suitable for general sentences, and is a default setting of the iR-ADV C series FLAG mode: Composition algorithm adopted by the iR C series VALUE mode, ROP mode: These modes are available based on the logic that the internal processing is possible, but they are basically not used.	MODE FURUYA* MODE FLAG MODE VALUE MODE ROP	

*1: Be sure to pull out the USB memory after unmounting it by turning USB-H to OFF because USB memory is in the mount state when USB-H is ON.
Pulling out the USB memory while it is being accessed causes an error.

T-5-51

LOG GR.

Item	Description	Setting range
SYSTEM LOG	Make a setting of the system log function.	ON / OFF
SUBLOG FTP GET	Sub log is collected without using the serial consol.	----
Logging Utility	Set to determine whether "Logging Utility" function in the utility menu is used. • ON: "Logging Utility" function is used. • OFF: "Logging Utility" function is not used.	ON / OFF [*]
DEBUGLOG-SW	Set to determine whether the sub log is automatically output when E code, Exception or Service Call occurs. • ON: Sub log is automatically output. • OFF: Sub log is not automatically output. Basic procedure: • In case that user sets manually from LUI: 1) Insert the USB memory by user. 2) Set the service switch "USB-H" to ON by user. 3) Set the service switch "DEBUGLOG-SW" to ON by user. 4) After an error occurs, record the debug log to USB memory from the menu (LUI) by user. 5) Perform the shutdown processing, and turn OFF and ON the main power switch of the machine by user. • In case of remote setting from RDS: 1) Insert the USB memory by user. 2) From RDS, set the service switch "DEBUGLOG-SW" to ON by service technician. 3) After an error occurs, the debug log is automatically recorded to USB memory. 4) Perform the shutdown processing, and turn OFF and ON the main power switch of the machine by service technician.	ON / OFF [*]
DEBUGLOG-MODE	To set the debug log mode.	MODE1 MODE2

T-5-52

F/W UPDATE GR.

Item	Description	Setting range
USB	Execute upgrading of the controller firmware. (Only USB is supported.)	----
NETWORK	Execute upgrading of the controller firmware.	----
CDS	Firmware auto/manual update function by MEAP application (updater)	----

T-5-53

NETWORK GR.

Item	Description		Setting range
DNSTRANS	Set to determine the priority order of protocol (IPv4/IPv6) to be used for DNS inquiry.		IP V. 4/IP V. 6 [*]
FTP SYSLOG	Make a setting of the various system log file acquisition function.		ON / OFF [*]
JOB SERIALIZE	Make a setting of the connection realize function.		ON / OFF [*]
BUFFER LIMIT	PSS buffer collection limit is cleared.		ON / OFF [*]
E-RDS	E-RDS SWITCH	Set to determine whether Embedded-RDS is used. • ON: Embedded-RDS is used. • OFF: Embedded-RDS is not used.	ON / OFF [*]
	RGW-ADDRESS	URL can be checked and set here. For the URL entry, use various keys (up/down/left/right keys, Job Status/Cancel key and Feeder Selection key). Then, press OK key to set the entry. In the very end of character strings, "down-pointing arrow" is displayed. Up to 128 characters can be entered.	----
	RGW-PORT	Set the port number of server.	1 to 443 [*] to 65535
	COM-TEST	Communication test is executed. The machine tries to connect to the server, judges whether it was connected, and displays the result.	----
	COM-LOG	Details of communication test result are displayed. When any error occurs, the time, error code and error information are displayed. Up to 5 logs can be stored and the latest log is displayed.	----
	CLEAR	Beside e-RDS setting value in the service mode, schedule information, alarm and filtering information are cleared.	----
	REDUCE SEND METHOD	To set whether to send information other than error to UGW at startup.	ON / OFF [*]
	CA-KEY	CLEAR	After executing this item, turn the power OFF/ ON to set the CA certificate to the default status.

Item	Description		Setting range
MIB CHARG ECOUNT	<ul style="list-style-type: none"> • ALL ACCESS: All information in the charge counter MIB can be collected. • DISP ACCESS: Information displayed on LUI in the charge counter MIB is displayed. • NON ACCESS: All information in the charge counter MIB cannot be collected. 		ALL ACCESS DISP ACCESS NON ACCESS
TCP DELAYED ACK	ON: TCP ACK delay function is enabled. OFF: TCP ACK delay function is disabled.		ON [*] / OFF
WOLtrans	1: Wake Up function using the new protocol (WSD) is enabled. Wake Up function with the old utility using CPCA Echo (broadcast) packet is not provided. 2: Wake Up function using the new protocol (WSD) is enabled. Wake Up function with the old utility using SNMP search broadcast packet is not provided. 3: Wake Up function using the old Canon utility is enabled. Wake Up function with the new protocol (WSD) is not provided.		1 [*] to 3
SLEEP ADVERTISE	SWITCH	Set to determine whether sleep notification is used.	ON [*] / OFF
	PORT	Set the port number as the address for sleep notification.	1 to 11427 [*] to 65535
	TTL	Set the number of routers which can exceed the number of sleep notification messages.	0 to 3 [*] to 254
	INTERVAL	Set the interval for sleep notification (unit: second).	60 to 600 [*] to 65535
PROXYRES	Set the proxy response function.		ON [*] / OFF
IPSEC SETTING	IKERETRY	To set the IKE retry times.	0 to 1 [*] to 3
	IKEINTVL	To set the IKE retry interval.	1 to 5 [*] to 30
	SPDALDEL	The default is "0"; when "1" is set, all registered policies are deleted at next startup to initialize policies. After completion of initialization, the value which has been set to "1" is automatically reset to "0".	0 to 1 (0 [*])
	IPSDEBLY	To set when obtaining IPsec log.	0 to 10 (0 [*])
	PFW SETTING	ILOGKEEP	Log retention time Possible setting range is 1 to 48 hours, and when the value in service mode is "0", it is 1 minute. Restart is required to reflect the setting.
ILOGMODE		Filter switching operation	0 to 1 (0 [*])
IPTBROAD		Multicast address application switching value	0 to 10 (0 [*])

Item	Description	Setting range
EAPOL_WT	Time to wait for a response (or the next request) to EAPOL packet sent by the device	10 to 30 to 120

T-5-54

■ SP.ADMIN.MODE

Item	Description	Setting range
MAINTENANCE C.	This item is displayed only when "Maintenance Code" is not set. By entering the Maintenance Code here, the menu item in the Special Administration Mode can be displayed.	----

T-5-55

Debug log

Sublog

Function Overview

Sublog is the record of behavior inside the Main Controller PCB.

In the case of a field failure that is hard to be reproduced, this measure is intended to improve efficiency in failure analysis and reduce the time for failure support by collecting debug log at the user site (which was created immediately after the failure) and sending it to the R&D.

When the Canon staff who is in charge of quality follow-up determines the need for an analysis of firmware debug log by the R&D department, we ask the field to collect log for an investigation to determine the cause.

Sublog

It is available only when the Sublog Board is installed on the Main Controller PCB.

When the Sublog Board is not installed, log is not saved anywhere.

It is stored in the Sublog Board and its content is stored even when the power is turned OFF to be displayable when the power is turned ON again.

The Sublog Board has a limited capacity and when the log exceeding this storage number is attempted to be stored, the log is deleted in the order of length of time stored.

Effective Instances of Collecting Debug Log

- The error occurs only at the customer site and cannot be reproduced by the sales company or the Canon staff who is in charge of quality follow-up.
- When the error frequency is low.
- When the error is suspected of links with firmware rather than a mechanical/electrical failure.
- Collection of Sublog is not necessary when the reproduction procedure is identified and the error can be reproduced by the sales company HQ or the Canon staff who is in charge of quality follow-up.

How the log is written

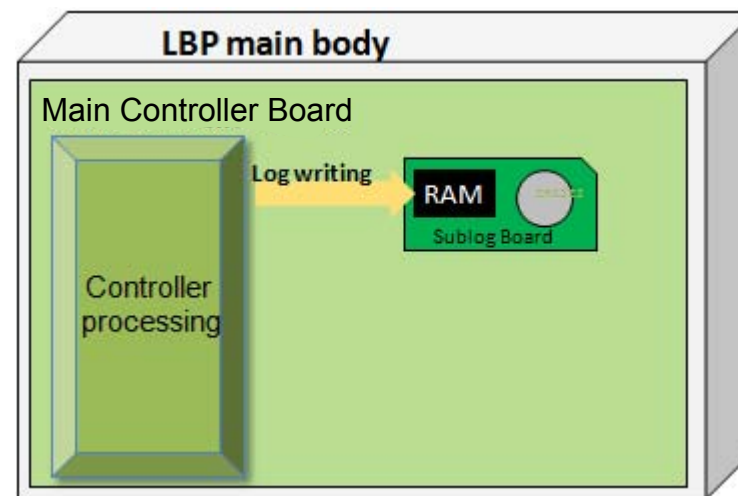

F-5-55

- In case of using the Sublog Board:
 - Write the log directly to RAM on the Sublog Board.
 - The on-board battery prevents data from being erased when the power is turned OFF.

Collecting Sublog

Flow of collecting Sublog

Installing the Sublog Board	Install the board to the host machine.
Generating the log	When the Sublog Board is installed, it records the log all time.
Collecting log	When setting LOG TO USBMEM in service mode, log is transferred to the USB memory device connected to the machine.

T-5-56

Installing the Sublog Board

Note:

The battery on Sublog board is located at BATS1 CR2032.
Push SW1 on the board and confirm that LED1 turns on.
If LED1 does not turn on, You need change battery.

CAUTION:

There is danger of explosion if the battery is replaced with an incorrect type.
Replace it only with the same type of battery.
Dispose of used batteries according to the manufacturer's instructions.

- 1) Remove the cover on the right side of the host machine.



- 2) Install the Sublog Expansion Board into the slot over the controller.

F-5-56



F-5-57



F-5-58

■ Generating the log

Generation of the log starts as soon as the Sublog Board is installed.

For example, when collecting the log of error, take the following steps immediately after the error occurred.

If the log is not swiftly collected, it is possible for the log written on the schedule to overwrite the target behavior log.

■ Collecting log

When setting LOG TO USBMEM in service mode, log is transferred to the USB memory device connected to the machine.

Log is transferred to the USB memory device connected to the machine in the following procedure.

1) Turn ON the power while pressing down the "<-", "OK" and "Online" simultaneously.

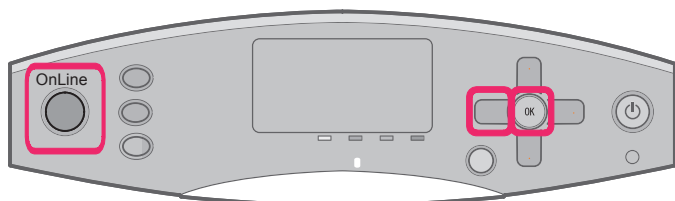

F-5-59

2) Scroll to the right and left to display "LOG TO USBMEM". Press the "↓" button to write to the USB memory device.

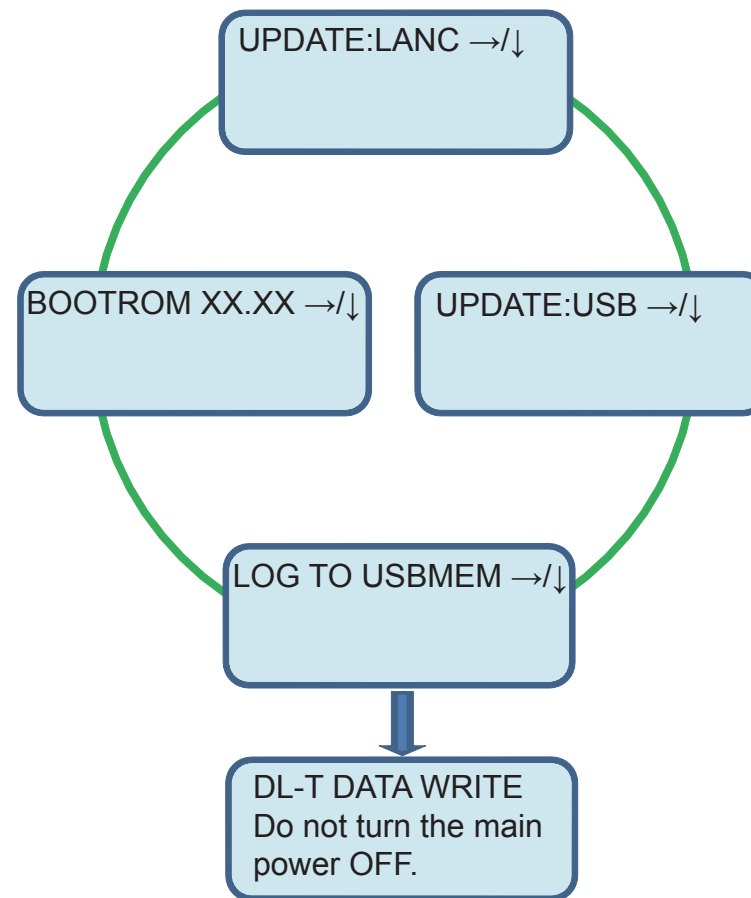

F-5-60

3) When the machine is restarted and "Printing is possible" is displayed after writing is complete, remove the USB memory device.

4) A sublog file named SUBLOG.BIN is output under /LOG_TMP of the USB memory device. Collect SUBLOG.BIN and send it to the department in charge of quality at the sales company.

 SUBLOG.BIN 6,124 KB

F-5-61

Backup/Restoration by Expansion ROM for servicing and Sublog Board

Function Overview

Data can be migrated to an unused Main Controller PCB by using the Expansion ROM for servicing + Sublog Board when the Main Controller PCB becomes faulty.

What to Prepare

- Sublog Board
- Expansion ROM for servicing
- Unused Main Controller PCB

CAUTION:

Install the Sublog Board to which data was backed up (exported) and Expansion ROM PCB to an unused Main Controller PCB which has not been installed to the machine.

Data cannot be migrated to a Main Controller PCB which has ever been used, even if only once.

Prerequisites

NOTE:

The battery on Sublog Board is located at BATS1 CR2032.
Push SW1 on the board and confirm that LED1 turns on.
If LED1 does not turn on, You need change battery.

CAUTION:

There is danger of explosion if the battery is replaced with an incorrect type.

Replace it only with the same type of battery.

Dispose of used batteries according to the manufacturer's instructions.

Target Data for Backup

User mode setting values
Service mode setting values
Page counter
Device serial number

T-5-57

Backup and Restoration (Export and Import)

Flow of Export and Import

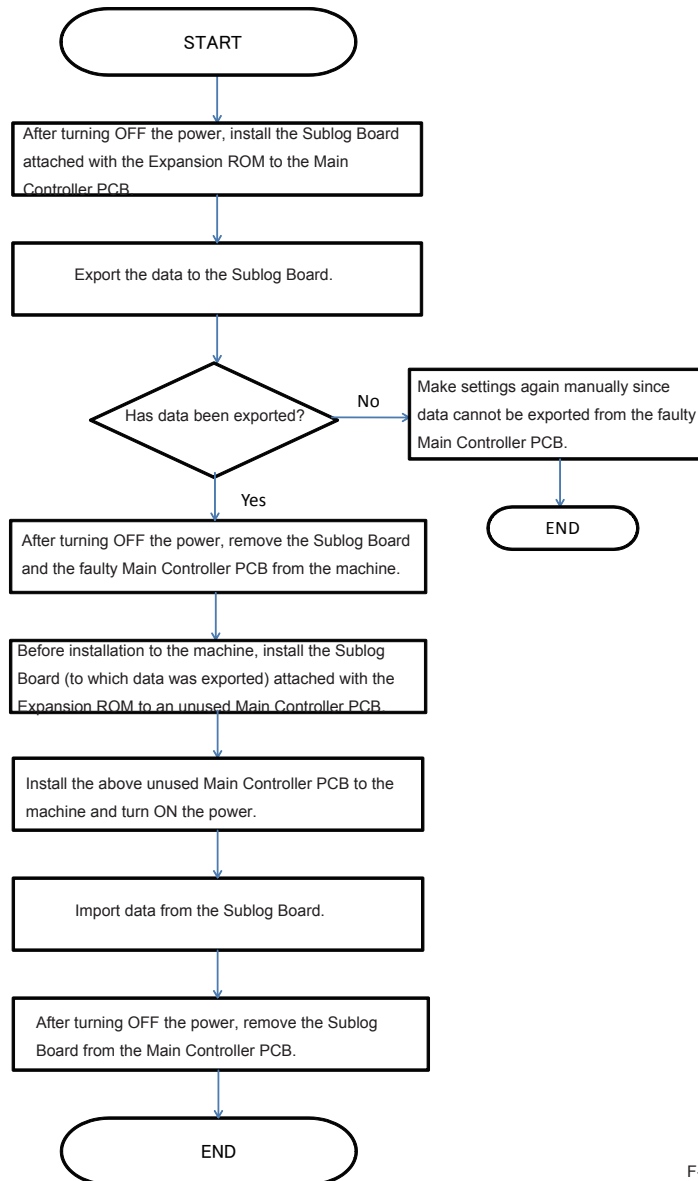

F-5-62

Installing the Expansion ROM for servicing and Sublog Board

1) Install the Expansion ROM for servicing to the Sublog Board.

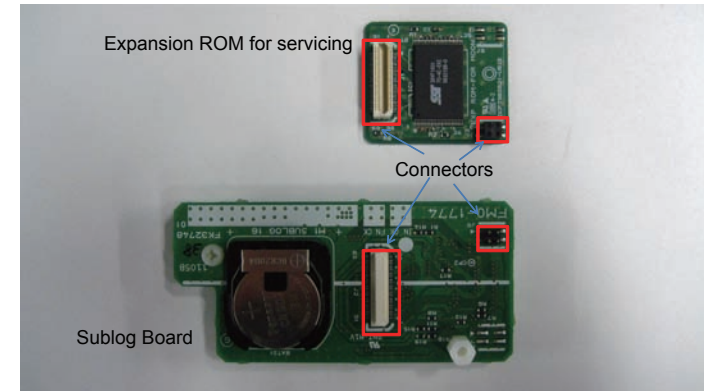

F-5-63

2) Install the above Sublog Board to the machine.



F-5-64

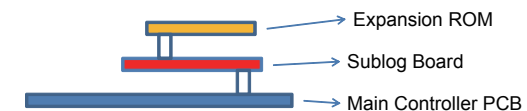

F-5-65

Backup Procedure (Export)

1) The menu is displayed when turning ON the power while the Sublog Board attached with the Expansion ROM for servicing is installed.

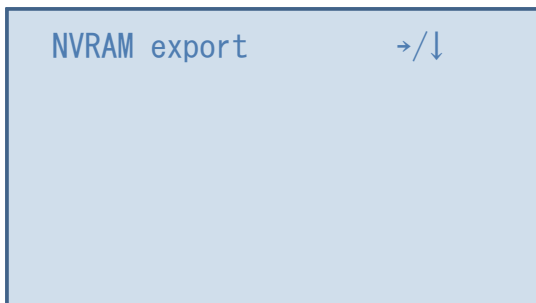

F-5-66

2) Use the right and left arrow keys to select [NVRAM export].

3) Press the OK key. This operation causes the information stored in the machine to be exported to the Sublog Board.

4) The following message is displayed when backup is completed successfully.



F-5-67

5) Turn OFF the power, and remove the faulty Main Controller PCB and the Sublog Board to which data was exported.

CAUTION:

Install the Sublog Board to which data was backed up (exported) and Expansion ROM PCB to an unused Main Controller PCB which has not been installed to the machine.

Data cannot be migrated to a Main Controller PCB which has ever been used, even if only once.

Restoration Procedure (Import)

1) Install the unused Main Controller PCB which has been installed with the Sublog Board (to which data was exported) attached with the Expansion ROM to the machine.

2) Turn ON the power and select [NVRAM import] in the menu, and then press the OK key. The information stored in the Sublog Board is written back to the machine.

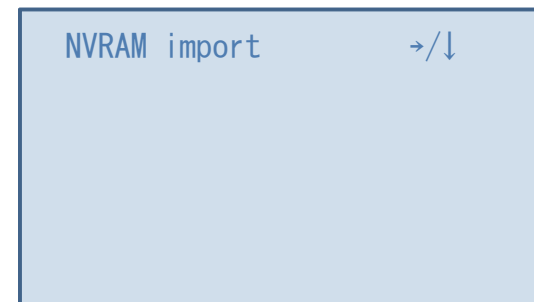

F-5-68

CAUTION:

When not replacing with an unused Main Controller PCB, the following message is displayed and the operation is stopped. In this case, turn OFF the power and replace with an unused Main Controller PCB.

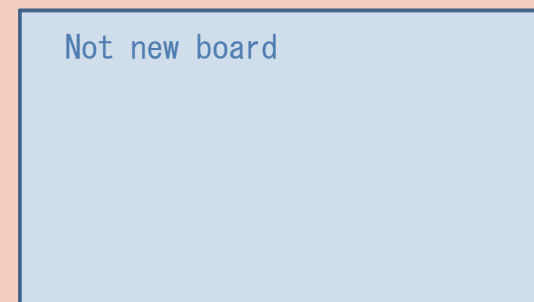

3) The data in the Sublog Board is deleted and the following message is displayed in the case of successful completion.

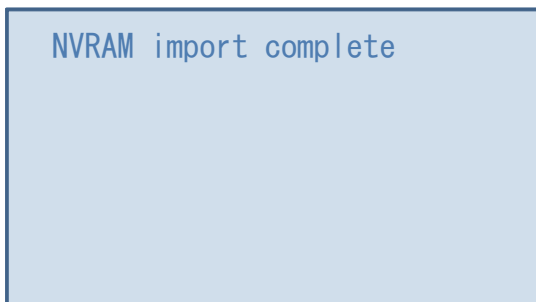

F-5-69

4) Turn OFF the power and remove the Sublog Board.

Others

Deletion (Erase)

When the data is not imported although it was exported, it needs to be deleted to prevent leakage of information.

1) Install the Sublog Board (containing data to be deleted) attached with the Expansion ROM to the Main Controller PCB.

2) Turn ON the power and select [NVRAM erase], and then delete the information stored in the Sublog Board.

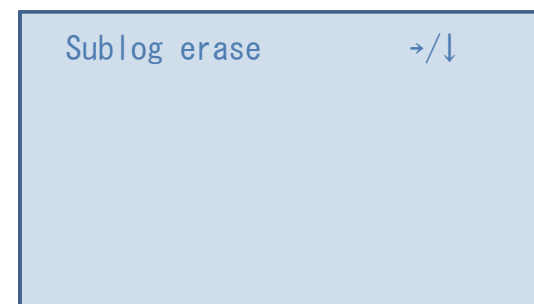

F-5-70

3) The following message is displayed in the case of successful completion.

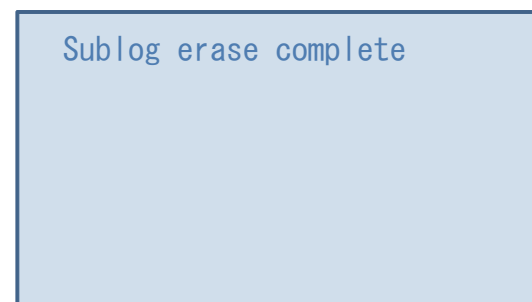

F-5-71

4) Turn OFF the power and remove the Sublog Board.

List of Error Messages

The following messages are displayed when certain failures occur during operation.

List of Messages	Detail
Sublog board not found	Sublog Board is not installed.
NVRAM read error	Export cannot be executed because the faulty Main Controller PCB is too damaged to retrieve information.
Sublog R/W error	When the same data cannot be read 3 consecutive times due to Sublog Board error, the error message is displayed and the operation is stopped.
NVRAM write error	When information cannot be written to an unused Main Controller PCB for some reasons, the error message is displayed and the operation is stopped.
Sublog data not found	When the export data is not stored in the Sublog Board (including checksum check error), import process or erase process cannot be executed.
Not new board	Import cannot be executed since the Main Controller PCB is not unused or the one to which no serial number has been written.
Different product	Data is attempted to be imported to a model different from the one from which data was exported.

T-5-58

Updater

Overview

Outline

Updater provides functions that enable network communication with Content Delivery System V1.0 (hereinafter CDS) to install firmware, MEAP applications and system options.

Firmware Installation

Updater function enables users to distribute firmware through CDS via Internet. Particularly on e-Maintenance/UGW (called NETEYE in Japan)-enabled devices, firmware can be updated remotely, which effectively slashes costs incurred in field services.

MEAP Application/System Option Installation

By linking devices to CDS and License Management System (providing the function to manage licenses; hereinafter LMS), applications can be installed in devices via Updater, regardless of those not embedded (MEAP application) or embedded (system options) in devices.

Installing Firmware

With link to Updater, service technicians provide firmware install services in the following 3 methods.

Distribution Method	Download Commanded by:	Update Timing	Downloadable Firmware Versions		
			Previous Ver	Current Ver	Newer Ver
a. UGW-linked Download / Update (Full-remote update)	UGW	Auto	No	Yes	Yes*1
b. UGW-linked Download (Remote Distribution / Update)	UGW	Manual	Yes	Yes	Yes
c. Update via SST	SST	-	Yes	Yes	Yes

*1:You can select the version allowed Remote Update.

T-5-59

a. UGW-linked Download and Update (Full-Remote Update)

If the device is linked to UGW and the distribution schedule and update setting are registered on UGW in advance, full remote firmware update is available. Upon downloaded from CDS, the firmware is updated on the device.

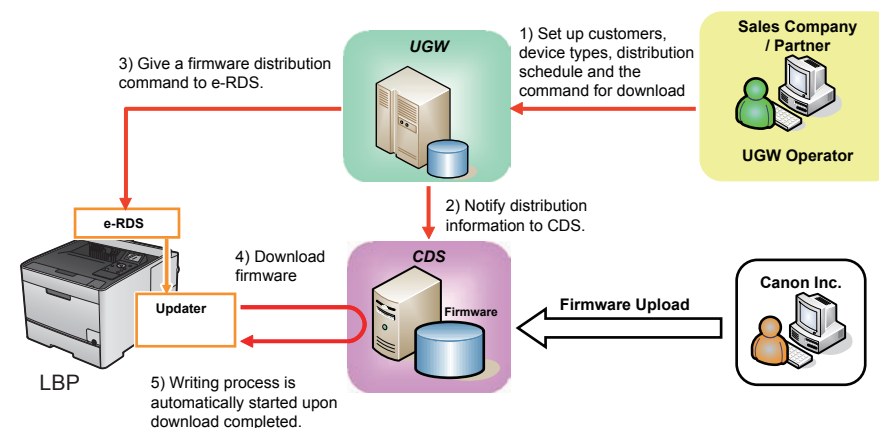

F-5-72

b. UGW-linked Download (Remote Distribution / Update)

If the device is linked to UGW and the distribution schedule is registered on UGW in advance, firmware can be distributed to the device before a service technician actually visits the customer site. This allows the service technician to update the firmware manually immediately after completing device inspection.

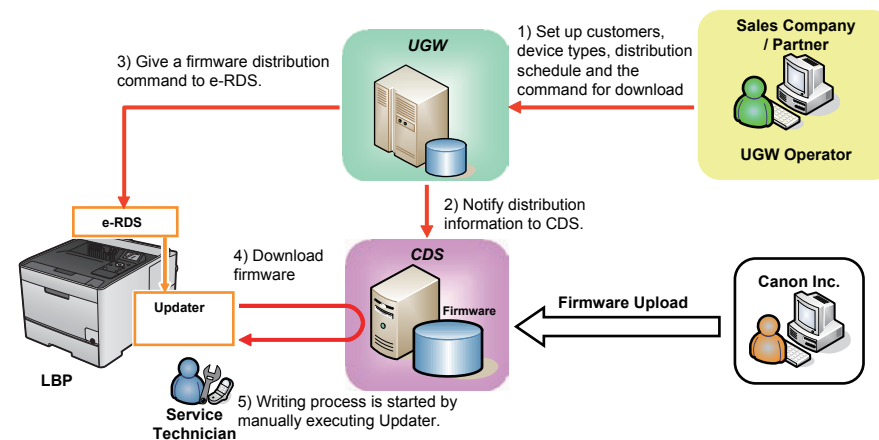

F-5-73

System Configuration

The figure below schematically shows the system configuration.

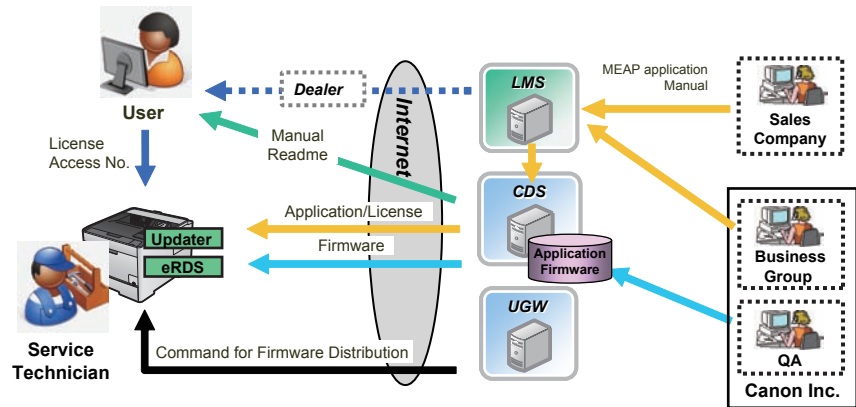

F-5-74

List of Functions

The matrix below shows the list of functions provided by Updater.

Category	Function	Remote UI	UGW-linked
Firmware	Checking firmware compatibility	-	-
	Checking special firmware	-	-
	Checking latest firmware version	Yes	-
	Registering/deleting firmware distribution schedule	Yes	-
	Confirming and downloading firmware	Yes	Yes
	Updating downloaded firmware	Yes	-
	Cancelling downloaded firmware	Yes	-
	Acquiring firmware distribution information registered from UGW	-	Yes
	Notifying firmware version information	-	Yes
	Periodical update	-	-
MEAP application/system option	Inquiring license for MEAP application option	Yes	-
	Installing MEAP application / system option	Yes	-
System Management	Settings	-	-
	Testing communications	Yes	-
	Displaying update logs	Yes	-
Internal system error notification	Displaying system logs	Yes	-
	Notifying internal system error occurrence to distribution server	Yes	Yes

T-5-60

Distribution Flow

Firmware Installation Flow

Service technicians provide firmware install services in the following 4 methods.

- a: UGW-linked download and update
- b: UGW-linked download
- c: Update via SST

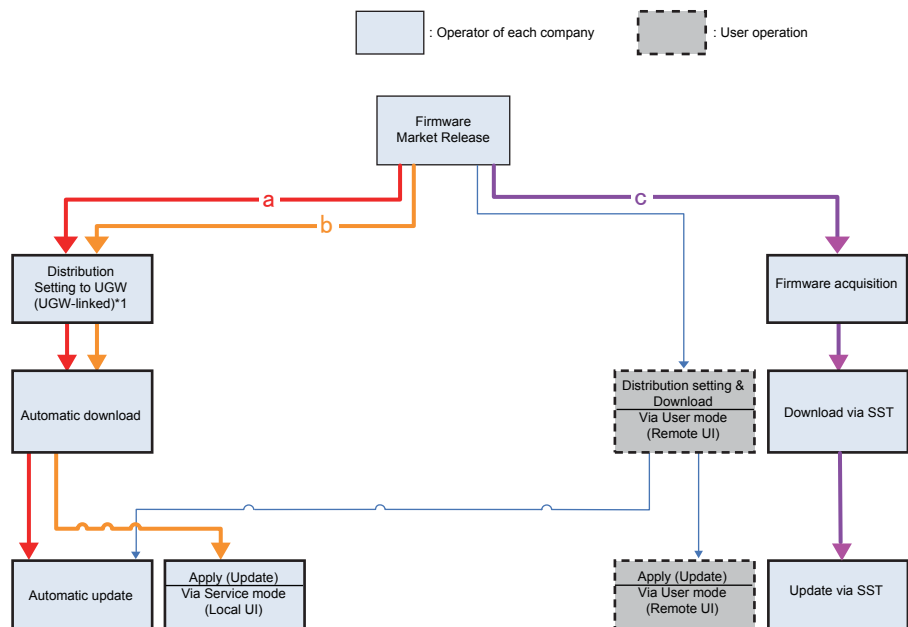

F-5-75

*1: Schedules for UGW-linked distribution are maintained on CDS.

MEAP Application/System Option Installation Flow

MEAP application/system option installation method using service mode is not provided.

Be sure to use the user mode to install.

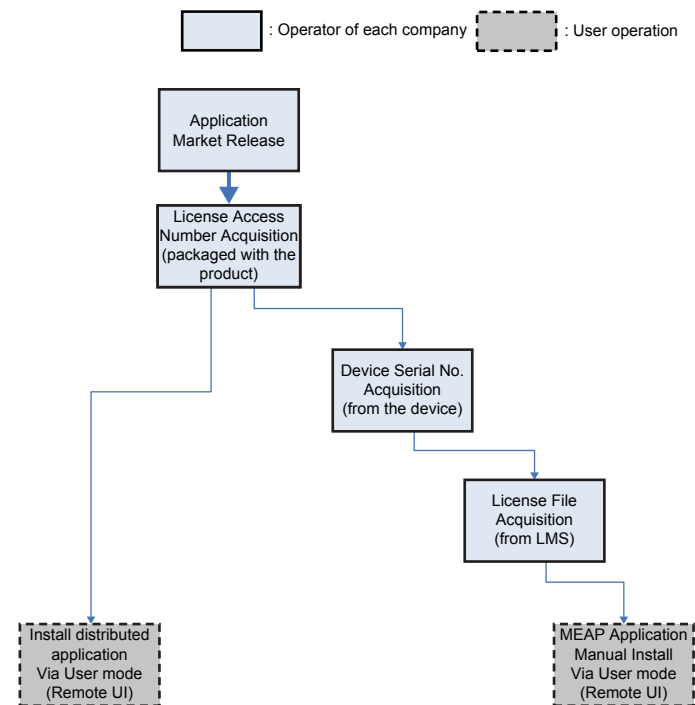

F-5-76

■ Limitations and Cautions

● Limitations

Changing Date/Time on Device

When a user changes the date/time setting on the device (including change of the setting according to daylight saving time), the firmware distribution may not be performed as scheduled.

But there is not the problem if it is time adjustment of several minutes with NTP servers.

Change of Setting from Service mode

Any settings from Service mode will be enabled after restarting the device.

● Cautions

Concurrent use of Updater functions

Multiple users cannot use Updater functions on a device concurrently by using it together with Remote UI.

Coexistence of Remote UI and other tools

Users logged in SMS (Service Management Service) are unable to use Update functions from Remote UI.

Using Updater function from Remote UI

Upon the following operations done, Updater functions are suspended from Remote UI for certain duration.

- When a user exits Web browser without clicking [Portal] or [Log Out] button in the setting of Remote Login Service via SMS
- When a user exits Web browser without clicking [Portal] button in the setting of not to use Remote Login Service via SMS.
- When a user exits Web browser without clicking [Log out from SMS] or [To Remote UI] button.

Wait for EOJ (end of job) Function

Firmware update will be triggered only after the following jobs are completed.

This is the Updater-specific specification.

Job/Function type	Receiving	Printing	Queued print jobs
PRINT	Wait for EOJ (end of job)	Wait for EOJ	Wait for EOJ
I-FAX Receipt	Cancel processing to trigger update *	Wait for EOJ	Wait for EOJ
Report Print	-	Wait for EOJ	Wait for EOJ

T-5-61

*The data are guaranteed even if cut off in the middle of a job. It becomes the recovery object after the device reboot and carry out send / reception again.

Even during transfer, Pull SCAN job processing is cancelled soon after scanning is completed.

Firmware update is cancelled if the jobs are not completed within 10 minutes. If this occurs, the error code, 8x001106, will be returned (different numbers will be shown for x depending on the execution modes).

Firmware update is executed if the jobs stated above are not in the queue.

Follow the shutdown sequence to reboot the device after the firmware is updated.

■ Preparation

● Overview of Preparation

The following should be prepared before using Updater.

- For updating of firmware

Installation Method	Setting Sales Company's HQ	Network Settings	Enabling UGW Link	Enabling [Update Firmware] Button of User Mode	Enabling [Manual Update] Button of User Mode (Remote UI)
UGW-linked Download and Update	Yes	Yes	Yes	-	-
UGW-linked Download	Yes	Yes	Yes	-	-

T-5-62

● Setting Sales Company's HQ

When using devices input in the markets listed below, the default setting of Sales Company's HQ should be changed before obtaining firmware distributed from CDS. Unless the setting is changed properly, the desired firmware may not be able to be selected.

Market	Default Setting of Sales Company's HQ	Setting of Sales Company's HQ after Change
Canada	US	CA
Latin America	US	LA

T-5-63

Go to the following screen to change the setting of Sales Company's HQ.

Service Technician	Setting of Device Service Mode	SERVICE MODE > FUNCTION GR. > MEAP > CDS-CTL
--------------------	--------------------------------	----------------------------------------------

NOTE:

The list below shows the setting of Sales Company's HQ for CDS-CTS by market. Check and adhere to the appropriate setting for your market.

<List of Sales Company's HQ and the settings for CDS-CTL>

Japan = JP

China = CN

USA = US

Hong Kong = HK

Singapore = SG

Australia = AU

Europe = NL

Canada = CA

Korea = KR

Latin America = LA

Network Settings

Connecting to External Network

The method of connecting to external network is similar to a normal network connection method. Refer to user manual of the device for details.

NOTE:

- Before using UGW link or User mode, see the sections below to prepare as required. "Enabling UGW Link"

NOTE:

"External Network" here means the network connecting the device to CDS via Internet.

Confirming URL Setting of Distribution Server

This section describes how to confirm the URL setting of the distribution server. One of the MEAP system service, [Register/Update Software(Management Settings)] is available.

1. You can log in it from a browser on a PC connected in a network.

Type the address [https://machine's IP address:8443/svm/].

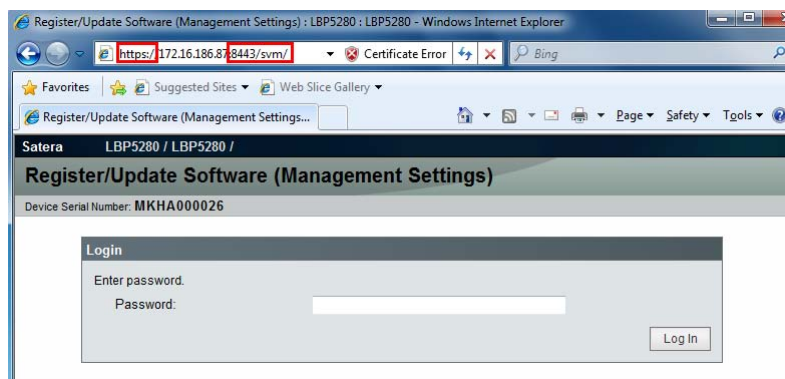

F-5-77

2. Type the password [*28*] then log in it.

Caution:

In the case of the following, you cannot log in even if you input a right password.

- The other user is using "Register/Update Software (Management Settings)" .
- The other user is using "Register/Update Software" in normal Remote UI.
- Because you have closed a browser without logging out definitely, you are still logging in it. Waiting for time-out.

3. After login, select [System Settings] > [Edit].

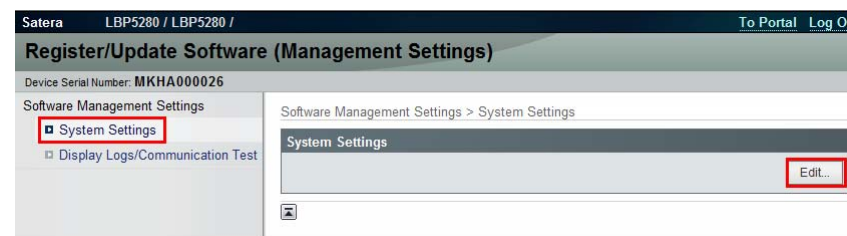

F-5-78

4. Confirm that "https://device.c-cdsknn.net/cds_soap/updaterif" is typed in [Delivery Server URL].

If the URL is not entered or wrong URL is entered, enter the right URL in [Delivery Server URL].

When you set output level of the log, input numerical value (0-4). Setting the bigger numerical value, you can get more detailed output log.



F-5-79

Caution:

The setting change of the output level influences a performance.

Refer to System Management Operations> Various Setting> Setting Log Level in detail.

5. When you have changed the settings, press [Configure] button. The confirmation dialog is displayed. If there is no problem, select [Yes]. In this, the URL of the delivery server and setting editing of the log output level are the end.

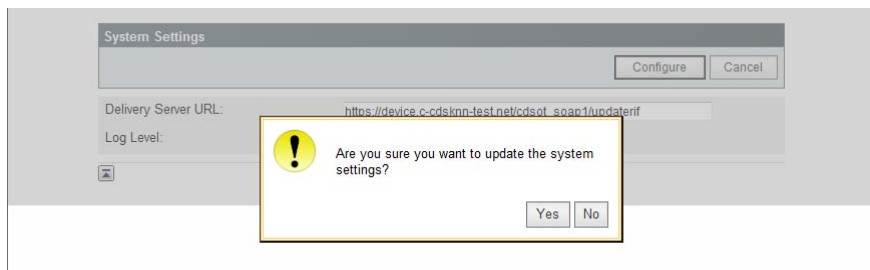

F-5-80

Communication Test

This section describes how to check if the communication is normally done to the distribution server and/or the file server.

Note:

CDS Server and RDS Server are different. So carry out the communication test with both Embedded RDS and CDS.

1. Enter [Register / Updater Software (Management Settings)].
2. Select [Display Logs / Communication Test] > [Communication Test].

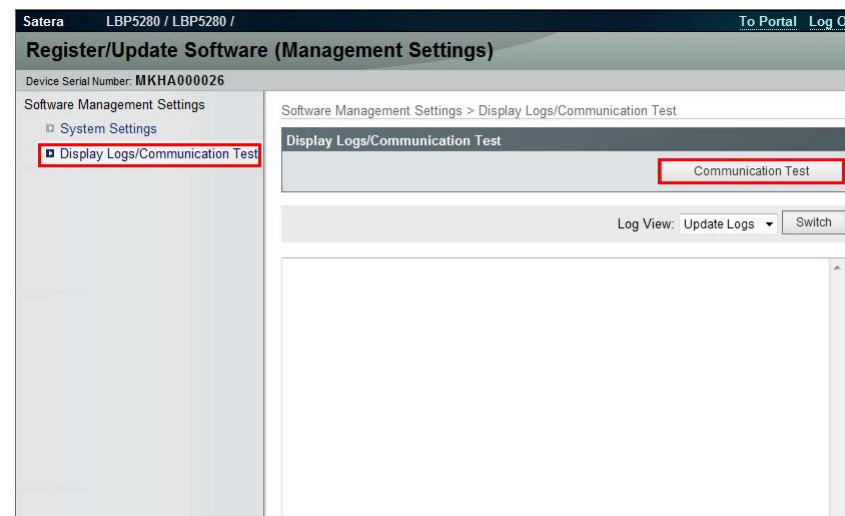

F-5-81

3. The Communication Test is carried out.

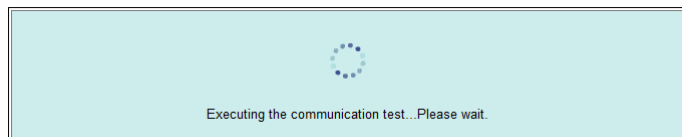

F-5-82

Obtain the download file information for communication test from the distribution server (to execute the communication test to the distribution server).

Using the download file information for communication test, the contents for test are downloaded from the file server (for the communication test to the file server).

4. Upon the communication test completed, the communication test result screen is shown. Press [OK] button to exit this operation.

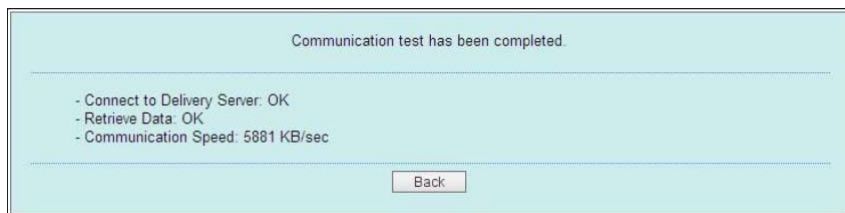

F-5-83

● Enabling UGW Link

When installing the firmware in the method of “UGW-linked Download and Update” or “UGW-linked Download”, the following should be set before actually using UGW link.

Service Technician	Setting of Device Service Mode	SERVICE MODE >FUNCTION GR. >MEAP >CDS-UGW (On -> Off)
	Setting of UGW WebPortal	In [Customer Management] screen, set [Do not distribute firmware] to [Distribute firmware].
Sales Company's HQ	Setting of Authorities on UGW WebPortal	See "Analysis>Firmware Distribution Information" to grant the appropriate authorities to each account.

NOTE:

- See “imageWARE Remote Operator's Manual / e-Maintenance Business Operation Manual” for how to operate UGW WebPortal.
- [Distribute Firmware] should be set on [Customer Management] screen for staff in charge of setting for [Enter customer information] or [Command for firmware distribution] in order to allow them to select the desired device on [Firmware Distribution Information] screen.
- If [Distribute Firmware] is not shown on [Customer Management] screen of UGW WebPortal, appropriate authorities may not be set to each account in Firmware Distribution Information. Contact the Sales Company HQ concerned for confirmation.

● Enabling [Install Application/Options] Button of User Mode (Remote UI)

To allow users to install applications using Updater, the setting of application installation should be set to ON for users in advance.

Service Technician	Setting of Device Service Mode	SERVICE MODE >FUNCTION GR. >MEAP >CDS-MEAP (On -> Off)
--------------------	--------------------------------	--------------------------------------------------------

- Remote UI screen of Updater when the setting is not enabled (CDS-MEAP(Off)):

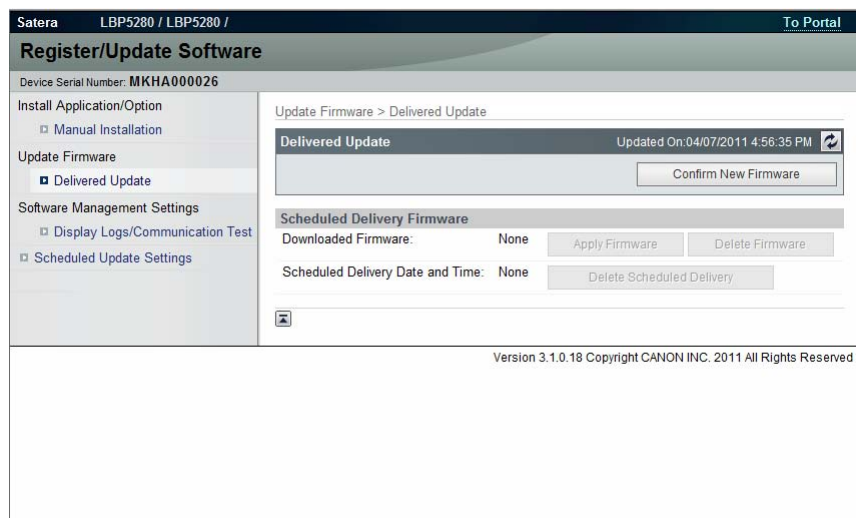

F-5-84

- Remote UI screen of Updater when the setting is enabled (CDS-MEAP(On)):

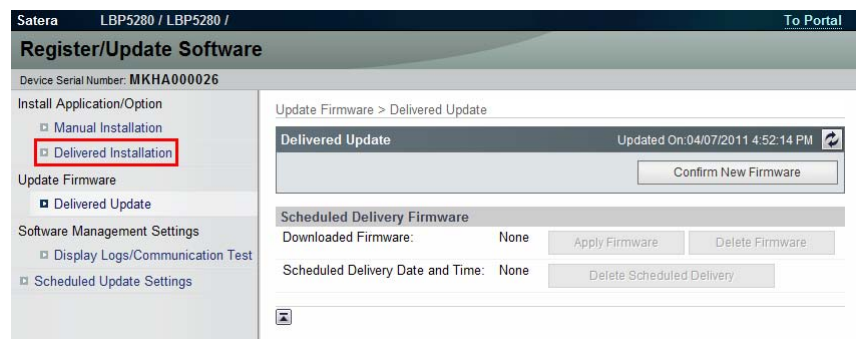

F-5-85

● Enabling [Manual Update] Button of User Mode (Remote UI)

To allow users to install firmware from Updater using the file on Local PCs, the setting of firmware installation should be set to ON for users in advance.

Service Technician	Setting of Device Service Mode	SERVICE MODE >FUNCTION GR. >MEAP >CDS-FIRM (On -> Off)
--------------------	--------------------------------	--------------------------------------------------------

- Remote UI screen of Updater when the setting is not enabled (CDS-FIRM (Off)):

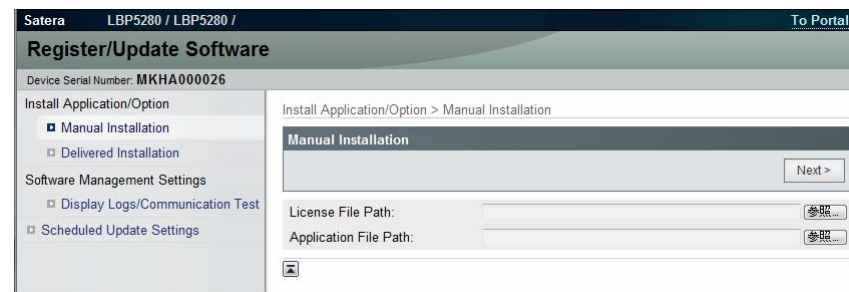

F-5-86

- Remote UI screen of Updater when the setting is enabled (CDS-FIRM):

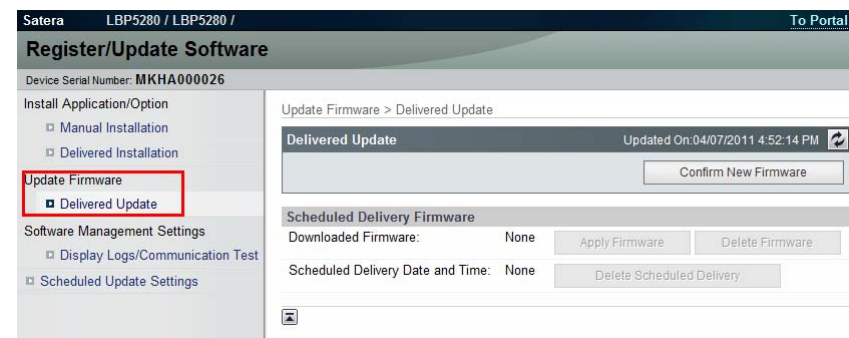

F-5-87

● Enabling [Scheduled Update] Button of User Mode

Service Technician	Setting of Device Service Mode	SERVICE MODE >FUNCTION GR. >MEAP >CDS-LVUP (On -> Off)
--------------------	--------------------------------	--------------------------------------------------------------

- Remote UI screen of Updater when the setting is not enabled (CDS-LVUP (Off)):

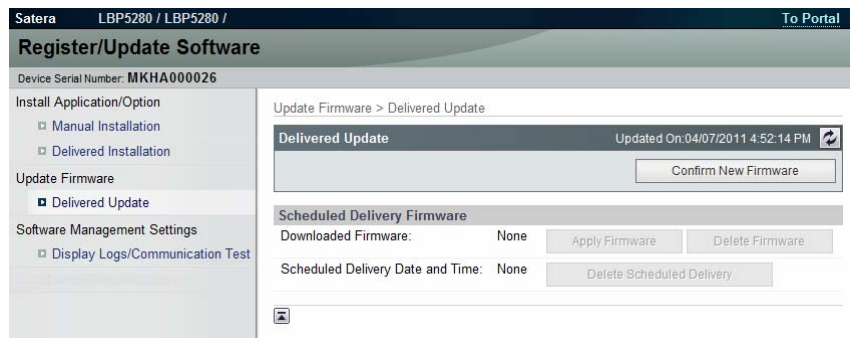

F-5-88

- Remote UI screen of Updater when the setting is enabled (CDS-LVUP (On)):

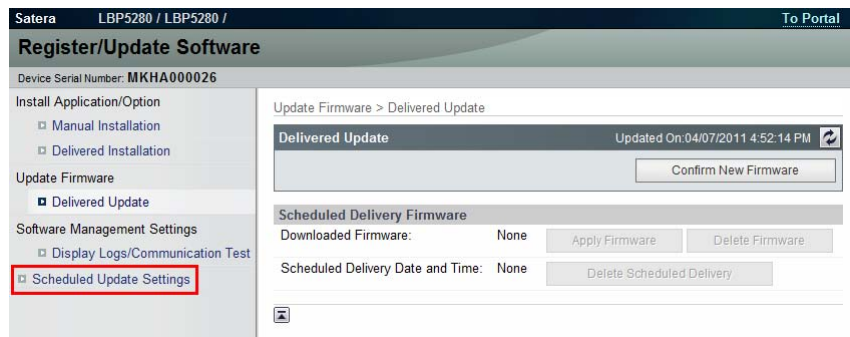

F-5-89

System Management Operations

Various Setting

Setting Log Level

This section describes how to set system log levels.

1. Activate [Register/Updater Software (Management Settings)] from browser.
 - 1). Enter [https://machine's IP address:8443/svm/] to the URL of browser.
 - 2). Type the password [*28*] then log in it.
 - 3). After login, select [System Settings] > [Edit].

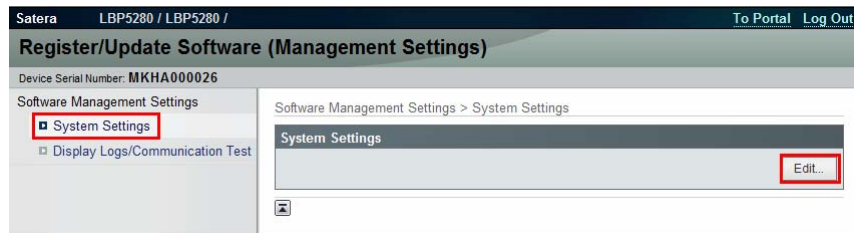

F-5-90

2. Select a log level from [Log Level] dropdown list.



F-5-91

- [Log Level]:
Select one of 5 levels ranging from [0] to [4]. (The default [3].)
See the table below for logs output in each level.

Log Level	Log Output				
	Trace	Information	Important Message	Ordinary Error	System Error
0	-	-	-	-	Yes
1	-	-	-	Yes	Yes
2	-	-	Yes	Yes	Yes
3	-	Yes	Yes	Yes	Yes
4	Yes	Yes	Yes	Yes	Yes

T-5-64

NOTE:

This list shows the contents of the Log Output.

Log Output	Description
Trace	Detailed logs for debug
Information	Logs related to operations done on the system
Important Message	Update logs output by firmware type Installation logs by MEAP application Logs related to enabled functions by system option
Ordinary Error	Logs for ordinary errors
System Error	Logs for internal system errors

3. Press [Configure] button to set the selected log level. Now the log level is successfully set.

Caution:

When you set it to log level 4, a performance falls, and the log acquisition takes time remarkably .

● Displaying Logs

Update Logs

This section describes how to confirm System Option/MEAP Application Installation Logs and Firmware Update Logs.

1. Select [Settings/Registration] > [License/Other] > [Register/Update Software] > [Display Logs/Communication Test] from management mode of Remote UI.

Note:

You can also access from [Register/Updater Software (Management Settings)] > [Display Logs/Communication Test]

2. Press [Update Logs] button.

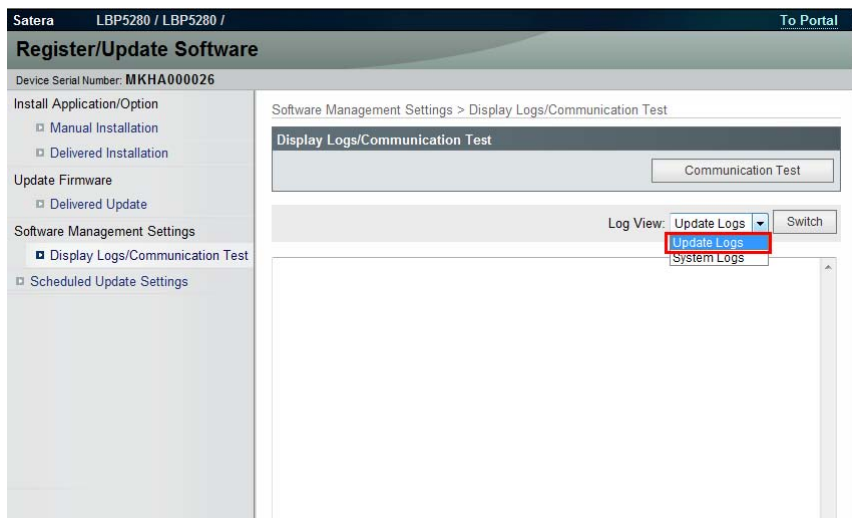

F-5-92

3. Press [Switch] button.

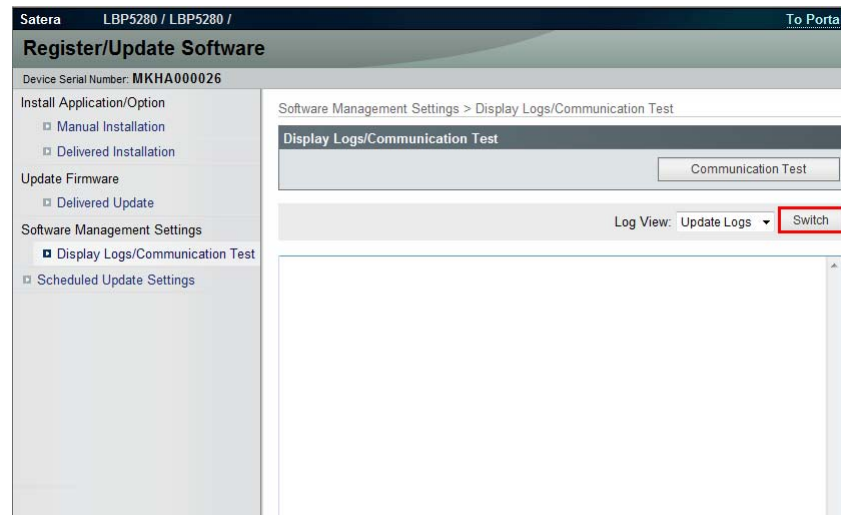

F-5-93

4. System Option/MEAP Application Installation Logs and Firmware Update Logs are shown.

System Logs

This section describes how to confirm System Logs.

1. Select [Settings/Registration] > [License/Other] > [Register/Update Software] > [Display Logs/Communication Test] from management mode of Remote UI.

Note:

You can also access from [Register/Updater Software (Management Settings)] > [Display Logs/Communication Test]

2. Press [System Logs] button.

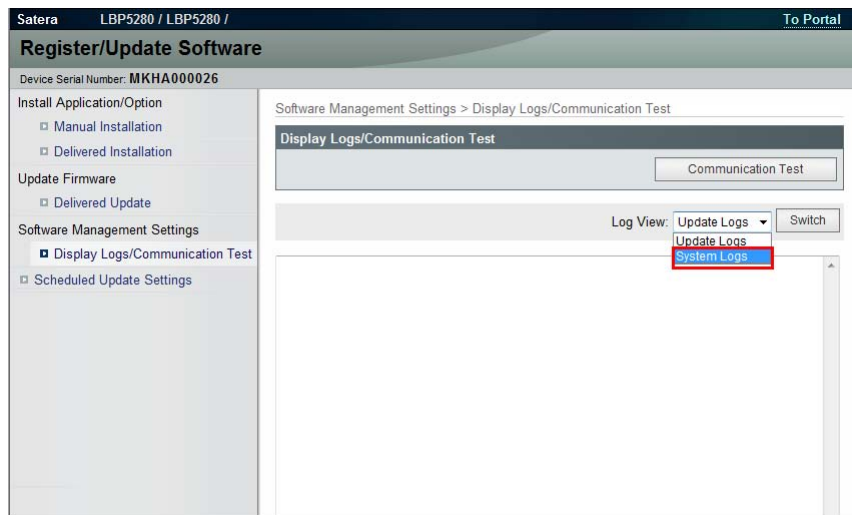

F-5-94

3. Press [Switch] button.

4. Updater internal logs are displayed.

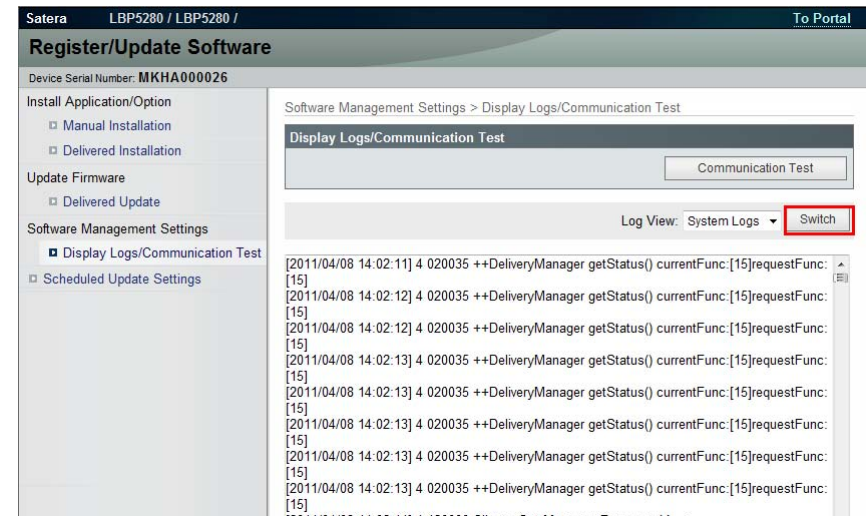

F-5-95

Note:

When you acquire the logs, do copy and paste of it.

■ Maintenance

● Upgrading Updater

The firmware installed in the device should be also upgraded when upgrading Updater. The setting information and logs (update logs/system logs) are inherited in the upgraded version.

● How to Replace Controller Boards

- Main Controller Board PCB (including SRAM)

The network and service mode setting should be set again after initialization. See "Preparation" in "Version Upgrade" of this manual for details.

● How to Replace Devices

All settings should be set again because no data are inherited. See "Preparation" in "Version Upgrade" of this manual for details.

FAQ

FAQ on Installing Firmware

No.1

Q: Is it also possible to downgrade firmware with using CDS?

A: Firmware can be downgraded in some methods shown in the table below.

If download and update are performed consecutively, firmware can't be downgraded.

Distribution Method	Downgrade Possibility
UGW-linked Download and Update	No
UGW-linked Download	Yes

T-5-65

No.2

Q: How can we confirm that the firmware is properly updated after "UGW-linked download and update" done?

A: You can confirm this in E-mail or the Device List on UGW-linked screen.

E-mail to notify firmware update will be sent from CDS server to the addresses set as destinations at the time of distribution setting to notify update completion.

On UGW-linked screen, search the device of your interest on [Select Device] screen to find the distribution status per device as shown in the search result.

No.3

Q: In the course of "UGW-linked download", what will happen if the user downloads the firmware before the service technician update the firmware downloaded with "UGW-linked download" before?

A: The previously downloaded firmware in the method of "UGW-linked download" will be overridden by the subsequently downloaded one.

This is because only one downloaded firmware can be held on the device.

The firmware downloaded in the method of "Service mode-linked download" and "UGW-linked download" can be checked/deleted from User mode, but cannot be updated, so it cannot be updated by the user unnoticed by the service technician.

No.4

Q: How is an individual response edition of firmware distributed?

A: Any individual response edition of firmware can be installed in all the methods provided by service technicians. Before installing the individual response edition, ensure to obtain the ID and password separately.

No.5

Q: If the device is down during firmware update, can the device be started using the older firmware version?

A: No, it is impossible to start the device using older versions. If this occurs, the service technician in charge should reinstall the firmware via SST. See "Troubleshooting on Firmware Installation" in chapter 6 of this manual for details.

No.6

Q: If the device is down during firmware download, is it possible to download the firmware again?

A: Firmware cannot be downloaded again automatically. Instead, the error is notified in E-mail. The user should register the firmware distribution schedule again accordingly.

No.7

Q: Can we cancel the operation during firmware download?

A: Yes. [Cancel] button is shown.

No.8

Q: E-mail is sent to users to notify update completion. Can service technicians also receive such a notification?

A: Yes. The notification E-mail is also set for the service technician in charge if the user enters his/her E-mail address at the time of firmware distribution setting.

Multiple E-mail addresses can be entered in the field. Delimit each E-mail address with “,” (comma) or “;” (semicolon) when you enter multiple E-mail addresses in the field.

No.9

Q: How long does the firmware update take?

A: Approx. 10 min. However, this does not include the download time. Download time relies on the network environment.

● FAQ on Installing MEAP Application/System Option

No.1

Q: What happens if a MEAP application is installed in the system with insufficient storage free space?

A: An error message is shown. Upon starting installation, the MEAP application checks the required space against free space to judge installation availability.

No.2

Q: Can we cancel the operation during installation of MEAP application?

A: Yes. [Cancel] button is shown.

No.3

Q: Is the device automatically restarted after the system option is enabled?

A: The device is not automatically restarted. Users should restart the device manually.

● FAQ on General Matters of Updater

No.1

Q: What preparation is needed in each installation method?

A: See the table below for preparation required in each installation method.

- For updating firmware

Installation Method	Setting Sales Company's HQ	Network Settings	Enabling UGW Link	Enabling [Update Firmware] Button of User Mode	Enabling [Manual Update] Button of User Mode (Remote UI)
UGW-linked Download and Update	Yes	Yes	Yes	-	-
UGW-linked Download	Yes	Yes	Yes	-	-

T-5-66

- For install Application

Installation Method	Network Settings	Enabling [Install Application/ Options] Button of User Mode (Remote UI)
LMS-linked Installation	Yes	-
LMS-linked installation via Remote UI	Yes	Yes

T-5-67

No.2

Q: How can operations using Updater be masked on the users' side?

A: Be sure to perform the following from the service mode.

- Masking Firmware Installation

Setting Device Service Mode	SERVICE MODE >FUNCTION GR. >MEAP >CDS-FIRM (On -> Off)
-----------------------------	-----------------------------------------------------------

- Masking Application Installation

Setting Device Service Mode	SERVICE MODE >FUNCTION GR.>MEAP >CDS-MEAP (On -> Off)
-----------------------------	----------------------------------------------------------

No.3

Q: Can the communication be cancelled during the communication test?

A: No. During the communication test, there is no "Cancel" button.

■ Error Messages

Error messages displayed in Remote UI are shown below. As to error codes, see the next list.

No.	Messages	Timing of display	Cause	Remedy
1	An error occurred with the delivery server. Contact your sales representative. Error Code: [xxx]	In communicating with the delivery server.	System error occurred in server.	Obtain the log etc. (Refer to "System Management Operations" under "Version Upgrade" of "Updater" in Chapter 6 "Troubleshooting" of this manual.) and contact Support Div. of the sales company.
2	Delivery server is stopped. Wait a while and then try to perform the operation again. Check the following URL for details. <Stopped Delivery Server URL>	In communicating with the delivery server.	Delivery server stopped.	Check the delivery server stop information. After the delivery server starts, perform the operation from this application. When the delivery server stop information is not available, contact the sales company's Support Department.
3	Failed to connect to delivery server. Check the delivery server and network.	In communicating with the delivery server.	Communication error due to incorrect settings of CDS URL. Excluding delivery server stop, communication error to the delivery server occurred.	Set correct CDS URL in the Updater settings. Check if the network environment is correct to solve the cause of the error occurrence. If the network environment of the device is correct, obtain the log etc. (Refer to "System Management Operations" under "Version Upgrade" of "Updater" in Chapter 6 "Troubleshooting" of this manual.) and contact Support Div. of the sales company.
4	Download was stopped because an error occurred with the file server. Check the network.	At the time of file download	Communication error to the delivery server occurred.	Check if the network environment is correct to solve the cause of the error occurrence. If the network environment of the device is correct, obtain the log etc. (Refer to "System Management Operations" under "Version Upgrade" of "Updater" in Chapter 6 "Troubleshooting" of this manual.) and contact Support Div. of the sales company.
5	Downloaded files are invalid. Check the network.	At the time of file download	The received file is broken.	After checking the network environment of the device, re-execute the job. If it recurs, obtain the log etc. (Refer to "System Management Operations" under "Version Upgrade" of "Updater" in Chapter 6 "Troubleshooting" of this manual.) and contact Support Div. of the sales company.
6	Failed to retrieve information of special firmware. Check the retrieval ID and password.	Acquisition of applicable firmware information	No information exists about firmware for special firmware retrieval ID or Password is invalid.	Enter the correct firmware ID or Password applicable to the firmware information. If it recurs, obtain the log etc. (Refer to "System Management Operations" under "Version Upgrade" of "Updater" in Chapter 6 "Troubleshooting" of this manual.) and contact Support Div. of the sales company.
7	Scheduled delivery information of firmware does not exist. Check it because it may already have been deleted.	Acquisition of applicable firmware information	Delivery information with specified delivery ID does not exist.	Register the delivery schedule again. If this occurs at the time of canceling file download, deleting downloaded firmware or deleting scheduled delivery, no remedy is required.
8	Failed to apply firmware.	Firmware application error	Error due to the application (NLM)	Obtain the log etc. (Refer to "System Management Operations" under "Version Upgrade" of "Updater" in Chapter 6 "Troubleshooting" of this manual.) and contact Support Div. of the sales company.

No.	Messages	Timing of display	Cause	Remedy
9	Delivery Server : Connect Failed File Server : Retrieve Failed Error Code: [xxxx]	Communication test, etc. (communication test result dialogue)	In the communication test, failed to connect to the delivery server.	Check the network environment of the device, and re-execute the job. If it recurs, obtain the log etc. (Refer to "System Management Operations" under "Version Upgrade" of "Updater" in Chapter 6 "Troubleshooting" of this manual.) and contact Support Div. of the sales company.
			In SOAP communication, failed to success after 1 min retry.	Set proxy and restart the communication test. If it recurs, obtain the log etc. (Refer to "System Management Operations" under "Version Upgrade" of "Updater" in Chapter 6 "Troubleshooting" of this manual.) and contact Support Div. of the sales company.
			ID and Password required for proxy to connect to the internet are not configured in device.	Set the user environment to make the access to the following domain available. https://device.cdsknn.net/ http://cdsknn.net.edgesuite.net/ If it recurs, obtain the log etc. (Refer to "System Management Operations" under "Version Upgrade" of "Updater" in Chapter 6 "Troubleshooting" of this manual.) and contact Support Div. of the sales company.
			The access to the network is limited.	Contact Field Support Group in the sale company. After confirmation that the delivery server has been restored, restart the communication test. If it recurs, obtain the log etc. (Refer to "System Management Operations" under "Version Upgrade" of "Updater" in Chapter 6 "Troubleshooting" of this manual.) and contact Support Div. of the sales company again.
10	Delivery Server : Connect OK File Server : Retrieve Failed Error Code: [XXXX]	Delivery Server : Connect OK File Server : Retrieve Failed Error Code: [XXXX]	Due to no return of data for the communication test, time-out (in HTTP communication, no response for 1min) occurred. After that, retried but failed to connect to server.	Check the network environment of the device and re-execute the job. If it recurs, obtain the log etc. (Refer to "System Management Operations" under "Version Upgrade" of "Updater" in Chapter 6 "Troubleshooting" of this manual.) and contact Support Div. of the sales company.
			The network cable was disconnected during data download in the communication test.	Reconnect the network cable and then restart the communication test. If it recurs, obtain the log etc. (Refer to "System Management Operations" under "Version Upgrade" of "Updater" in Chapter 6 "Troubleshooting" of this manual.) and contact Support Div. of the sales company.
			The file server stopped during data download in the communication test.	Contact the sales company's Support Department. After confirmation that the delivery server has been restored, restart the communication test. If it recurs, obtain the log etc. (Refer to "System Management Operations" under "Version Upgrade" of "Updater" in Chapter 6 "Troubleshooting" of this manual.) and contact Support Div. of the sales company again.
			Hash value in the communication test file is incorrect.	Check the network environment and re-execute the job. If it recurs, obtain the log etc. (Refer to "System Management Operations" under "Version Upgrade" of "Updater" in Chapter 6 "Troubleshooting" of this manual.) and contact Support Div. of the sales company.

No.	Messages	Timing of display	Cause	Remedy
11	An error occurred. Error Code: [xxx]	communication test, etc. (main screen)	The max value (space/file) was exceeded and new log was not accepted. Normally an old log file is deleted before the max value (space/file) is exceeded, but error may occur due to other element (e.g. I/O error).	Check if the log file exceeded the max value. <Update log> Max space: 128KB/file Max file number: 4 <System log> Max space: 512KB/file Max file number: 4 If it recurs, obtain the log etc. (Refer to "System Management Operations" under "Version Upgrade" of "Updater" in Chapter 6 "Troubleshooting" of this manual.) and contact Support Div. of the sales company.
			Notice of version information (main screen)	Failed to acquire version information of device due to no CDS registration of firmware version of device.
		At the time of notifying version information, failed to connect to the delivery server.	Check if the network environment is correct to solve the cause of the error occurrence. If the network environment of the device is correct, obtain the log etc. (Refer to "System Management Operations" under "Version Upgrade" of "Updater" in Chapter 6 "Troubleshooting" of this manual.) and contact Support Div. of the sales company.	
		No return of notifying version information	Re-connect the network cable and re-execute the job. If it recurs, obtain the log etc. (Refer to "System Management Operations" under "Version Upgrade" of "Updater" in Chapter 6 "Troubleshooting" of this manual.) and contact Support Div. of the sales company.	
		Network cable was disconnected during notice of version information.	Re-execute the job. If it recurs, obtain the log etc. (Refer to "System Management Operations" under "Version Upgrade" of "Updater" in Chapter 6 "Troubleshooting" of this manual.) and contact Support Div. of the sales company.	
		Failed to send notice of version information since the main power was turned OFF and then ON during the sending.	Check the network environment of the device and re-execute the job. If it recurs, obtain the log etc. (Refer to "System Management Operations" under "Version Upgrade" of "Updater" in Chapter 6 "Troubleshooting" of this manual.) and contact Support Div. of the sales company.	
		Server stopped at the time of sending notice of version information.	Obtain the log etc. (Refer to "System Management Operations" under "Version Upgrade" of "Updater" in Chapter 6 "Troubleshooting" of this manual.) and contact Support Div. of the sales company.	
An internal error occurred at the time of sending notice of version information.	Obtain the log etc. (Refer to "System Management Operations" under "Version Upgrade" of "Updater" in Chapter 6 "Troubleshooting" of this manual.) and contact Support Div. of the sales company.			

No.	Messages	Timing of display	Cause	Remedy
11	An error occurred. Error Code: [xxx]	UGW linkage (main screen)	UGW linkage was turned ON when eRDS was OFF.	For a device using eRDS, turn ON the eRDS. For a device not using eRDS, turn OFF the UGW linkage. If it recurs, obtain the log etc. (Refer to "System Management Operations" under "Version Upgrade" of "Updater" in Chapter 6 "Troubleshooting" of this manual.) and contact Support Div. of the sales company.
			An internal error occurred at the time of acquiring delivery information.	Re-execute the job. If it recurs, obtain the log etc. (Refer to "System Management Operations" under "Version Upgrade" of "Updater" in Chapter 6 "Troubleshooting" of this manual.) and contact Support Div. of the sales company.
		On-site (error dialogue)	An internal error occurred at the time of acquiring applicable firmware information.	Re-execute the job. If it recurs, obtain the log etc. (Refer to "System Management Operations" under "Version Upgrade" of "Updater" in Chapter 6 "Troubleshooting" of this manual.) and contact Support Div. of the sales company.
			An internal error occurred at the time of sending approval information.	Re-execute the job. If it recurs, obtain the log etc. (Refer to "System Management Operations" under "Version Upgrade" of "Updater" in Chapter 6 "Troubleshooting" of this manual.) and contact Support Div. of the sales company.
			An internal error occurred at the time of delivery order	Re-execute the job. If it recurs, obtain the log etc. (Refer to "System Management Operations" under "Version Upgrade" of "Updater" in Chapter 6 "Troubleshooting" of this manual.) and contact Support Div. of the sales company.
		Immediate download (error dialogue)	An internal error occurred at the time of requesting firmware delivery information.	Re-execute the job. If it recurs, obtain the log etc. (Refer to "System Management Operations" under "Version Upgrade" of "Updater" in Chapter 6 "Troubleshooting" of this manual.) and contact Support Div. of the sales company.
			During the download, all space in the storage disk was occupied. (DiskFull)	After adding vacant space of the storage disk, re-execute the job. If it recurs, obtain the log etc. (Refer to "System Management Operations" under "Version Upgrade" of "Updater" in Chapter 6 "Troubleshooting" of this manual.) and contact Support Div. of the sales company.
			At the end of receipt, an internal error occurred.	Re-execute the job. If it recurs, obtain the log etc. (Refer to "System Management Operations" under "Version Upgrade" of "Updater" in Chapter 6 "Troubleshooting" of this manual.) and contact Support Div. of the sales company.
		Manual update (error dialogue)	At the update start, an internal error occurred.	Re-execute the job. If it recurs, obtain the log etc. (Refer to "System Management Operations" under "Version Upgrade" of "Updater" in Chapter 6 "Troubleshooting" of this manual.) and contact Support Div. of the sales company
		Automatic update (error dialogue)	At the update start, an internal error occurred.	Re-execute the job. If it recurs, obtain the log etc. (Refer to "System Management Operations" under "Version Upgrade" of "Updater" in Chapter 6 "Troubleshooting" of this manual.) and contact Support Div. of the sales company.
		Deletion of downloaded firmware	At the time of notifying cancellation, an internal error occurred.	Re-execute the job. If it recurs, obtain the log etc. (Refer to "System Management Operations" under "Version Upgrade" of "Updater" in Chapter 6 "Troubleshooting" of this manual.) and contact Support Div. of the sales company.

No.	Messages	Timing of display	Cause	Remedy
12	An error occurred. Check the Update Firmware screen.	UGW linkage (main screen)	eRDS sent an order but Updater failed to connect to server.	Conduct a communication test to analyze the cause of the error. After solving the cause, resend the order from the eRDS. If it recurs, obtain the log etc. (Refer to "System Management Operations" under "Version Upgrade" of "Updater" in Chapter 6 "Troubleshooting" of this manual.) and contact Support Div. of the sales company.
			Delivery server stopped.	Contact the sales company's Support Department. After confirming restoration of the delivery server, re-execute the job. If it recurs, obtain the log etc. (Refer to "System Management Operations" under "Version Upgrade" of "Updater" in Chapter 6 "Troubleshooting" of this manual.) and contact Support Div. of the sales company.
			Scheduled date and time acquired from the delivery server was before current time (15 or more min had passed.)	Do the delivery setting from UGW again. If it recurs, obtain the log etc. (Refer to "System Management Operations" under "Version Upgrade" of "Updater" in Chapter 6 "Troubleshooting" of this manual.) and contact Support Div. of the sales company.
			Scheduled data and time acquired from the delivery server did not exist.	Do the delivery setting from UGW again. If it recurs, obtain the log etc. (Refer to "System Management Operations" under "Version Upgrade" of "Updater" in Chapter 6 "Troubleshooting" of this manual.) and contact Support Div. of the sales company.
		Immediate download (main screen)	At the time of immediate download, turned OFF and then ON the power of device main body.	Re-execute the job. If it recurs, obtain the log etc. (Refer to "System Management Operations" under "Version Upgrade" of "Updater" in Chapter 6 "Troubleshooting" of this manual.) and contact Support Div. of the sales company.
		Manual update (main screen) Automatic update (main screen)	Updated version was different from the ordered version.	Re-execute the job. If it recurs, obtain the log etc. (Refer to "System Management Operations" under "Version Upgrade" of "Updater" in Chapter 6 "Troubleshooting" of this manual.) and contact Support Div. of the sales company.
			After the update, failed to connect to the delivery server.	Check the network environment and re-execute the job. If it recurs, obtain the log etc. (Refer to "System Management Operations" under "Version Upgrade" of "Updater" in Chapter 6 "Troubleshooting" of this manual.) and contact Support Div. of the sales company.
			After the update, delivery server stopped.	Contact the sales company's Support Department. After confirming restoration of the delivery server, re-execute the job. If it recurs, obtain the log etc. (Refer to "System Management Operations" under "Version Upgrade" of "Updater" in Chapter 6 "Troubleshooting" of this manual.) and contact Support Div. of the sales company.
			After the update, the network cable was disconnected.	Re-connect the network cable and re-execute the job. If it recurs, obtain the log etc. (Refer to "System Management Operations" under "Version Upgrade" of "Updater" in Chapter 6 "Troubleshooting" of this manual.) and contact Support Div. of the sales company.
			After the update, server returned an error.	Obtain the log etc. (Refer to "System Management Operations" under "Version Upgrade" of "Updater" in Chapter 6 "Troubleshooting" of this manual.) and contact Support Div. of the sales company.
			After the update, an internal error occurred.	If it recurs, obtain the log etc. (Refer to "System Management Operations" under "Version Upgrade" of "Updater" in Chapter 6 "Troubleshooting" of this manual.) and contact Support Div. of the sales company.

No.	Messages	Timing of display	Cause	Remedy
13	Delivery Error Error Code: [xxx]	UGW linkage (Update Firmware screen)	eRDS sent an order but Updater failed to connect to the server.	Conduct a communication test to analyze the cause of the error. After solving the cause, resend the order from the eRDS. If it recurs, obtain the log etc. (Refer to "System Management Operations" under "Version Upgrade" of "Updater" in Chapter 6 "Troubleshooting" of this manual.) and contact Support Div. of the sales company.
			The delivery server stopped.	Contact the sales company's Support Department. After confirming restoration of the delivery server, re-execute the job. If it recurs, obtain the log etc. (Refer to "System Management Operations" under "Version Upgrade" of "Updater" in Chapter 6 "Troubleshooting" of this manual.) and contact Support Div. of the sales company.
			The scheduled data and time acquired from delivery server does not exist.	Do the delivery setting from UGW again. If it recurs, obtain the log etc. (Refer to "System Management Operations" under "Version Upgrade" of "Updater" in Chapter 6 "Troubleshooting" of this manual.) and contact Support Div. of the sales company.
14	Delivery Error Delivery Time Delivery Firmware Label Delivery Firmware version Error Code: [xxx]	UGW linkage (Update Firmware screen)	The scheduled date and time acquired from delivery server was before current time (15 or more min had passed).	Do the delivery setting from UGW again. If it recurs, obtain the log etc. (Refer to "System Management Operations" under "Version Upgrade" of "Updater" in Chapter 6 "Troubleshooting" of this manual.) and contact Support Div. of the sales company.
		Immediate download (Update Firmware screen)	At the time of immediate download, turned OFF and then ON the power of device main body.	Re-execute the job. If it recurs, obtain the log etc. (Refer to "System Management Operations" under "Version Upgrade" of "Updater" in Chapter 6 "Troubleshooting" of this manual.) and contact Support Div. of the sales company.
15	Applicable firmware is not registered.	On-site (error dialogue)	At the user site, no latest firmware exists.	This means the current firmware is the latest, so this error has no impact. But when the latest firmware to be retrieved must exist e.g. released new firmware information has been notified, contact Field Support Group in the sales company.
			No applicable firmware exists on CDS, so the service person can't select any applicable firmware.	Contact the sales company's Support Department.
16	Restart failed. Turn the main power OFF and ON.	Manual update (error dialogue)	An error occurred at the time of the device restart.	After turning OFF and then ON the main power of the device, re-execute the job. If it recurs, obtain the log etc. (Refer to "System Management Operations" under "Version Upgrade" of "Updater" in Chapter 6 "Troubleshooting" of this manual.) and contact Support Div. of the sales company.
		Automatic update (error dialogue)	An error occurred at the time of the device restart.	After turning OFF and then ON the main power of the device, re-execute the job. If it recurs, obtain the log etc. (Refer to "System Management Operations" under "Version Upgrade" of "Updater" in Chapter 6 "Troubleshooting" of this manual.) and contact Support Div. of the sales company.
17	Specify [E-Mail Address] with up to 64 characters.	At the time of periodical update setting	The specified E-mail address exceeded 64 characters.	Specify E-mail address within 64 characters.
18	The following characters cannot be used for the [E-Mail Address]: .;"()[]<>\	At the time of periodical update setting	The E-mail address was including the characters which could not be used.	Do not specify E-mail address with characters which cannot be used.
19	Specify [Comments] with up to 128 characters.	At the time of periodical update setting	Comments exceeded 128 characters.	Specify comments within 128 characters.
20	The [Delivery Server URL] is incorrect.	In setting with the deliver server URL.	The specified deliver server URL is wrong.	Enter the right URL(https://device.c-cdsknn.net/cds_soap/updaterif)

T-5-68

Error Codes

Error Codes displayed on Remote UI and how to read them.

How to read an error code

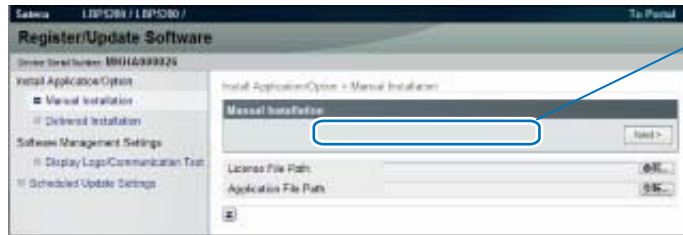

84014206

Code	Value	Contents
The first digit Error field	8	Error
The second digit Operator	0 1 2 3 4 5	Not defined. CDS server Updater UGW Service person IT administrator (User)
The 3rd - 4th digits Method category	xx	Method
The 5th digit Category code	0 1 2 3 4 5 6 7	Category code
The 6 - 8th digits Description code	000-	See Error code list

F-5-96

Error Code

The error code list is shown below. Remedy are error codes of "-", and for all the error codes out of the list, contact Field Support Group in the sales company.

Error Code (hex number)					Description	Remedy	Cause of error							
The first digit Error field	The second digit Operator	The 3rd - 4th digits Method category	The 5th digit Category code	The 6 - 8th digits Description code			CDS delivery server	UP DATER	CDS file server	Network				
8	Error													
	0													
	1													
		x	x		Relating method code									
				0	Not categorized									
				0	0	1				No value is set in a mandatory data entry item	-	-	-	-
				0	0	2				In a string type of a data entry item, digit number and/or character type is/are set against the regulations	-	-	-	-

Error Code (hex number)					Description	Remedy	Cause of error					
The first digit Error field	The second digit Operator	The 3rd - 4th digits Method category	The 5th digit Category code	The 6 - 8th digits Description code			CDS delivery server	UP DATER	CDS file server	Network		
				0 0 3	In an data entry item, the value is set against the regulations (E.g. the set value is other than "Operator: 4. Service person, 5. User")		-	✓	-	-		
				0 0 4	No applicable delivery information exists		✓	-	-	-		
				0 0 5	The setting of the system is imperfect		✓	-	-	-		
			1	Operation								
				0 0 1	Inconsistency between the current firmware component in the data entry item and delivery information (E.g. the conditions for automatic update are not met. The settings of a mandatory additional set are invalid)		✓	✓	-	-		
				0 0 2	In a notice of delivery-allowed information, an install-set was release to the market, but the market release was stopped during the delivery		✓	-	-	-		
				0 0 3	No mail template file exists		✓	-	-	-		
				0 0 4	The device serial number in the data entry item differs from that in delivery information		✓	-	-	-		
				0 0 5	User is selected as Operator in the data entry items and the retrieval type is other than the latest		✓	-	-	-		
				0 0 6	The retrieval type in the data entry item is special and registration ID and individual Password are not set (* Operator did not enter registration ID and individual Password)		✓	-	-	-		
				0 0 7	The retrieval type in the data entry item is special and Operator is not Service person		✓	-	-	-		
				0 0 8	As to the device serial number in the data entry items, there is no applicable device code product		✓	-	-	-		
				0 0 9	The retrieval type in the data entry items is special and there are no basic-set applicable to the registration ID and Password (* When wrong registration ID or Password was entered by an operator)		✓	-	-	-		
				0 0 A	The delivery status is Applying		✓	-	-	-		
				0 0 B	No approval information exists about EULA or the export criteria when the delivery is determined		✓	-	-	-		
				0 0 C	The delivery status is Distributing/Distributed/Applying/Finished/Failed		✓	-	-	-		
				0 0 D	The delivery status is Distributing/Distributed/Applying/Finished/Failed		✓	-	-	-		
				0 0 E	The delivery status is New/Waiting to Distribute/Distributed/Applying/Finished/Failed		✓	-	-	-		
				0 0 F	The delivery code is other than Distributing. (Firmware delivery)		✓	-	-	-		
				0 1 0	The delivery status is New/Waiting to Distribute/Distributing/Applying/Finished/Failed		✓	-	-	-		
				0 1 1	The delivery status is Distributing/Distributed/Applying/Finished/Failed		✓	-	-	-		
				0 1 2	Device is "Not applicable to CDS" (Firmware delivery)		✓	-	-	-		

Error Code (hex number)					Description	Remedy	Cause of error			
The first digit Error field	The second digit Operator	The 3rd - 4th digits Method category	The 5th digit Category code	The 6 - 8th digits Description code			CDS delivery server	UP DATER	CDS file server	Network
				0 1 3	The delivery time which specified is in CDS delivery stop time	-	✓	-	-	
				0 1 4	The firmware reservation status of confirmation time-out	-	✓	-	-	
				0 1 5	The firmware delivery time-out	-	✓	-	-	
				0 1 6	The version upgrade of firmware is time-out	-	✓	-	-	
			2	I/O						
				0 0 1	The specified license access number does not exist in LMS	-	✓	-	-	
				0 0 2	The specified license access number has been deauthorized	-	✓	-	-	
				0 0 3	The package product of the entered license access number doesn't include MEAP application/System Option	-	✓	-	-	
				0 0 4	The sales company for the MEAP application isn't identical with the sale company for the package product	-	✓	-	-	
				0 0 5	The number of licenses to be issued will exceed the limit number allowed to register	-	✓	-	-	
				0 0 6	As for System Option for the same function, the license keys were issued more than the defined number of times for the same device serial number	-	✓	-	-	
				0 0 7	No device product exists applicable to the optional product	-	✓	-	-	
				0 0 8	No product exists applicable to the device serial number	-	✓	-	-	
				0 0 9	The product of the entered license access number cannot be used with this device because the settings of the sales company are incorrect	-	✓	-	-	
				0 0 A	No product linked to the license access number is registered in CDS for delivery	-	✓	-	-	
				0 0 B	Although the product linked to the license access number is registered in CDS for delivery, the delivery is stopped now	-	✓	-	-	
				0 0 C	No existence of optional product applicable to the device serial number.	-	✓	-	-	
				0 0 D	The license access number has been registered for another device	-	✓	-	-	
				0 0 E	For the device product applicable to the device serial number, no available software (MEAP application, System Option) exists	-	✓	-	-	
				0 1 0	LMS system error	-	✓	-	-	
			2~5							
		x	x		Relating method code					
				0	Not cartelized					
				0 0 0	Not defined	Normally not indicated				
				1 0 0	Unknown error	Normally not indicated				
			1		Operation					
				0 0 1	Processing exclusively	Start the operation again after terminating other Updater operations being executed simultaneously	-	✓	-	
				1 0 1	Failed to process preparation for use		-	✓	-	
				1 0 2	Failed to process use end		-	✓	-	
				1 0 3	Time out during restart of readiness preparation		-	✓	-	

Error Code (hex number)						Description	Remedy	Cause of error				
The first digit Error field	The second digit Operator	The 3rd - 4th digits Method category	The 5th digit Category code	The 6 - 8th digits Description code				CDS delivery server	UP DATER	CDS file server	Network	
				1	0	4	Session time-out excluding after application inquiry (after issuing delivery ID)	Start the operation again from the beginning		✓	-	-
				1	0	5	CDS URL is not set	Set CDS URL	-	✓	-	-
				1	0	6	There is another job	Start the operation again after terminating the job of the device	-	✓	-	-
				2	0	1	Appointment of the periodical update for the periodical update non-support model		✓	-	-	-
			2	I/O								
				1	x	x	An internal error about file operation	-	-	✓	-	-
				2	x	x	An internal error about XML file operation	-	-	✓	-	-
				3	0	1	Failed to output the license file	-	-	✓	-	-
			3	Device								
				1	x	x	An internal error in CPCA	-	-	✓	-	-
				2	x	x	An internal error in IMI	-	-	✓	-	-
				3	x	x	An internal error in SMS	-	-	✓	-	-
				4	x	x	An internal error in NLM	-	-	✓	-	-
				6	0	1	A permit acquisition error in APL CDS partition	-	-	✓	-	-
			4	SOAP communication								
				1	0	1	The processing thread stopped	-	-	✓	-	-
				1	0	2	Processing SOAP communication now	-	-	✓	-	-
				1	0	3	The function type is not matched	-	-	✓	-	-
				1	0	4	An invalid SOAP response error	-	✓	-	-	-
				2	0	1	An internal error about application information	-	-	✓	-	-
				2	0	2	config.xml is NOT FOUND	-	-	✓	-	-
				2	0	3	type.xml is NOT FOUND	-	-	✓	-	-
				2	0	4	An error in binding type.xml	-	-	✓	-	-
				2	0	5	An error in creating a service tab	-	-	✓	-	-
				2	0	6	A runtime error in performing the web method	-	-	✓	-	✓
				2	0	7	An unknown host error in performing the web method	<ul style="list-style-type: none"> Check the network environment of the device and start the operation again Check if the URL settings of the CDS server are correct, and start the operation again after resetting 	✓	✓	-	✓
				3	0	1	The delivery server is stopped	-	✓	-	-	-
				3	0	2	An error occurrence in the delivery server	-	✓	✓	-	-
			5	HTTP communication								
				1	0	1	Specified Hash Algorithm is unknown	-	-	✓	-	-
				2	0	1	Invalid HTTP request	-	-	✓	✓	✓
				2	0	2	Failed to connect to the server	Check the network environment of the device and start the operation again	-	✓	✓	✓
				2	0	3	Failed to find the server	Check the network environment of the device and start the operation again	-	✓	✓	✓
				2	0	4	An input/output error occurred during the connecting process to the server	-	-	✓	✓	✓
				2	0	5	Failed to read a HTTP response	-	-	✓	✓	✓
				2	0	6	Error in a HTTP response	-	-	✓	✓	✓
				3	0	1	Failed to retrieve the data stream	-	-	✓	-	✓
				3	0	2	Failed to create the file object for receipt	-	-	✓	-	✓
				3	0	3	Failed to create the data stream of the file for receipt	-	-	✓	-	✓

Error Code (hex number)					Description	Remedy	Cause of error					
The first digit Error field	The second digit Operator	The 3rd - 4th digits Method category	The 5th digit Category code	The 6 - 8th digits Description code			CDS delivery server	UP DATER	CDS file server	Network		
				3 0 4	Failed to receive the data	Check the network environment of the device and start the operation again	-	✓	✓	✓		
				3 0 5	An error about reserving the file data for receipt	-	-	✓	-	-		
				3 0 6	Failed to close the data stream	-	-	✓	-	-		
				3 0 7	Failed to close the file data for receipt	-	-	✓	-	-		
				3 0 8	Invalid hash code of the download file	Check the network environment of the device and start the operation again	✓	✓	✓	✓		
				3 0 9	The proxy authorization method is not applicable	Check the proxy authentication method used, and start the operation again after changing the settings to use the corresponding proxy authentication	-	✓	-	✓		
			6	Socket communication								
				1 0 1	Failed to connect the eRDS	-	-	✓	-	✓		
				1 0 2	No response from eRDS	-	-	✓	-	✓		
				1 0 3	No notice of start from the eRDS	-	-	✓	-	✓		
				1 0 4	Error of socket reading	-	-	✓	-	✓		
				1 0 5	Socket communication time-out	-	-	✓	-	✓		
			7	Other internal codes								
				0 0 2	One of installation, start or authorization failed (When installation or authorization failed, it is regarded as an error) *	-	-	✓	-	-		
				0 3 x	An internal error in processing the installation	-	-	✓	-	-		
				1 x x	An error by using invalid API	-	-	✓	-	-		
				2 x x	An internal error in SMS	-	-	✓	-	-		
				3 0 1	No existence of delivery ID	-	-	✓	-	-		
				3 0 2	Invalid delivery ID	-	-	✓	-	-		
				3 0 3	The updated firmware information is not identical with the firmware information after activation of the Updater	-	-	✓	-	-		
				3 0 4	The process of firmware download is incomplete	-	-	✓	-	-		
				3 0 5	The update process is incomplete	-	-	✓	-	-		
				3 0 6	The installment process is incomplete	-	-	✓	-	-		
				4 0 1	Failed to retrieve delivery information	-	-	✓	-	-		
				5 0 1	Failed to execute the delivery process	-	-	✓	-	-		
				5 0 2	The scheduled delivery was not executed within the defined period of time	Scheduled deliveries not executed within the defined period of time are abandoned, so register a scheduled delivery again. When setting the date and time of the scheduled delivery, be sure to designate a time when the device is ON	-	✓	-	-		

T-5-69

* Not displayed on a device UI

Appendix

- General Timing Chart
- General Circuit Diagram
- Signal Input/Output List
- Backup Data

General Timing Chart

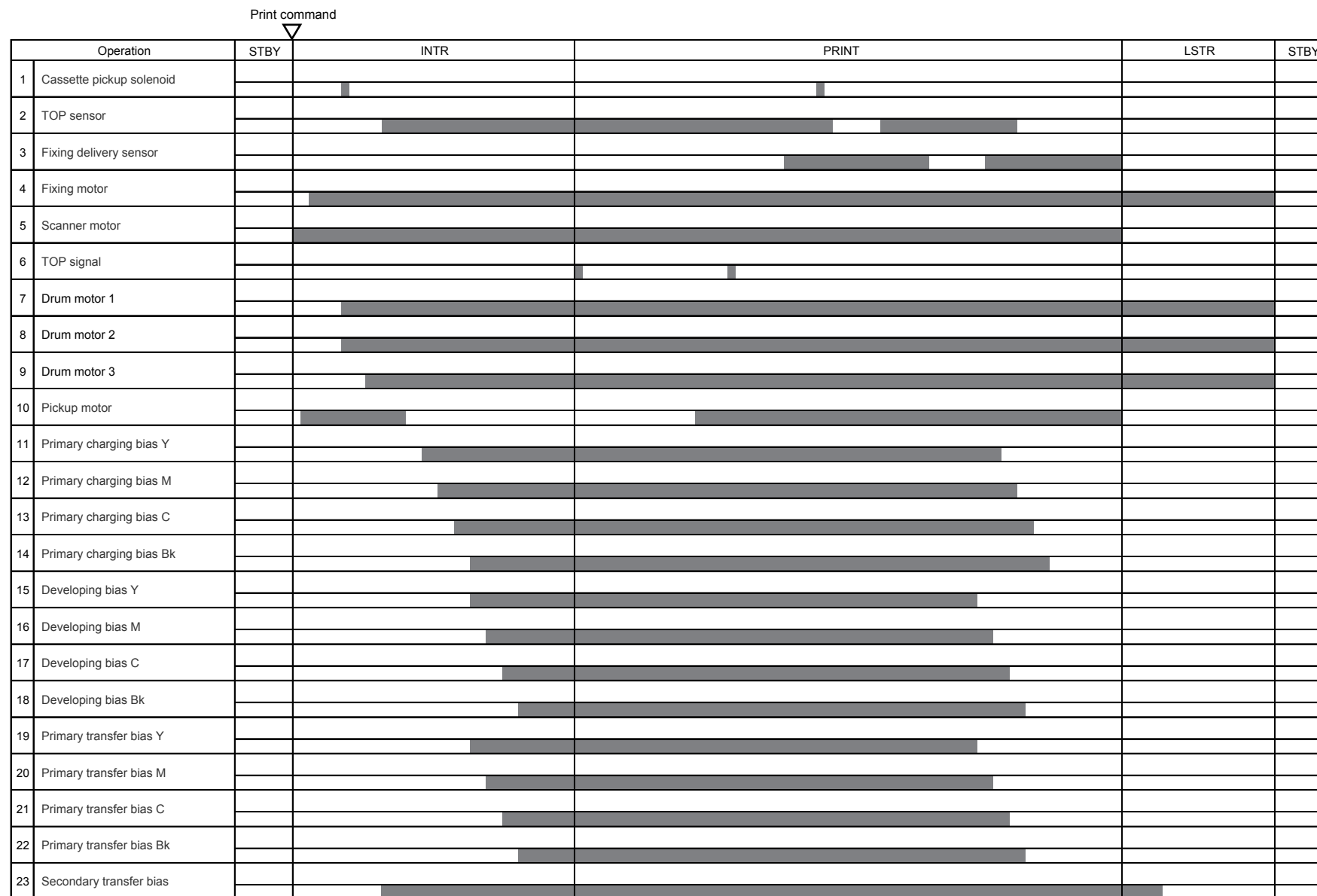

F-6-1

General Circuit Diagram

General Circuit Diagram (1/2)

Appendix > General Circuit Diagram > General Circuit Diagram (1/2)

Appendix > General Circuit Diagram > General Circuit Diagram (1/2)

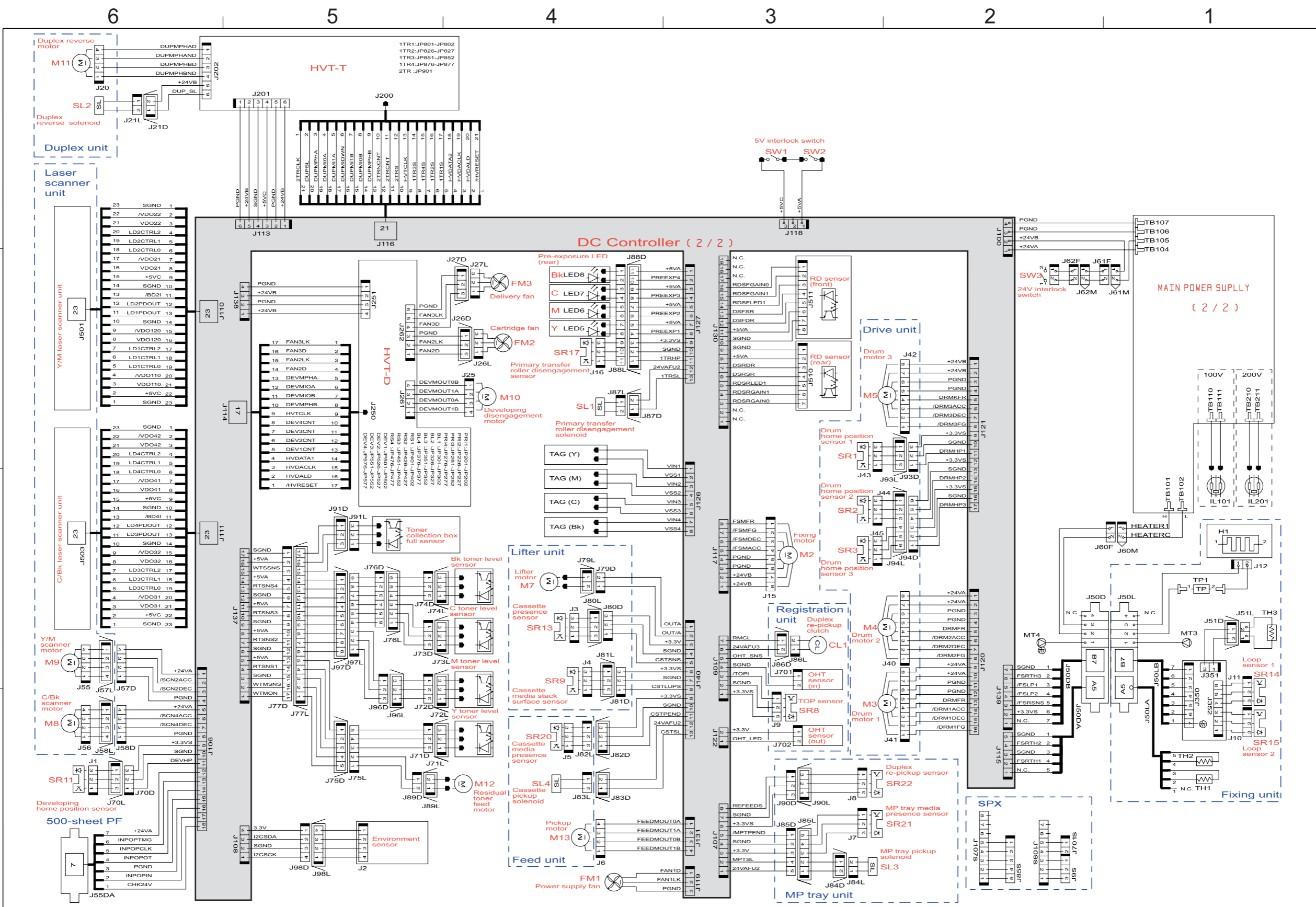

D

C

B

A

F-6-2

General Circuit Diagram (2/2)

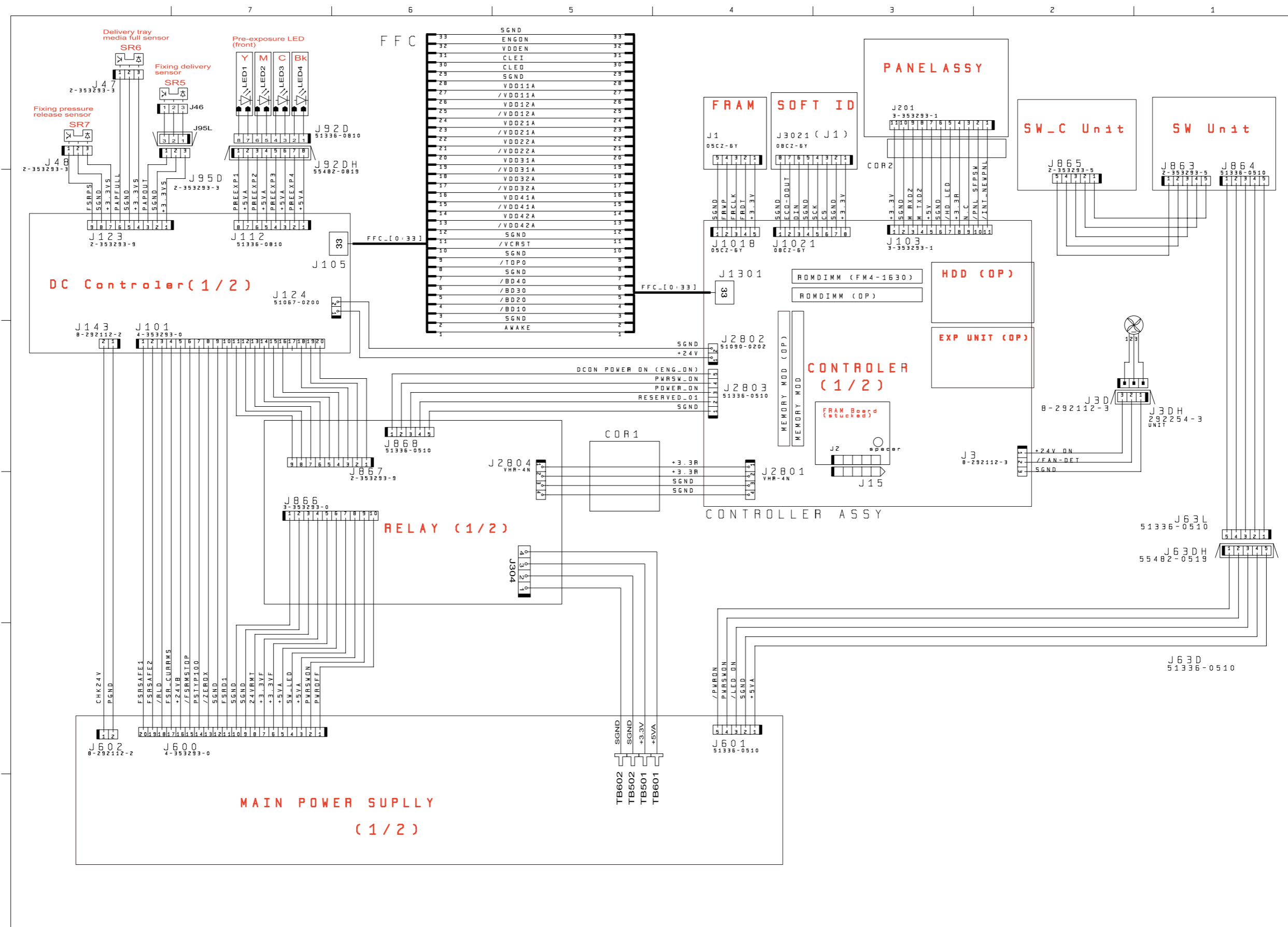

F-63

Appendix > General Circuit Diagram > General Circuit Diagram (2/2)

Appendix > General Circuit Diagram > General Circuit Diagram (2/2)

General Circuit Diagram (1/2) (LBP7780C/5480)

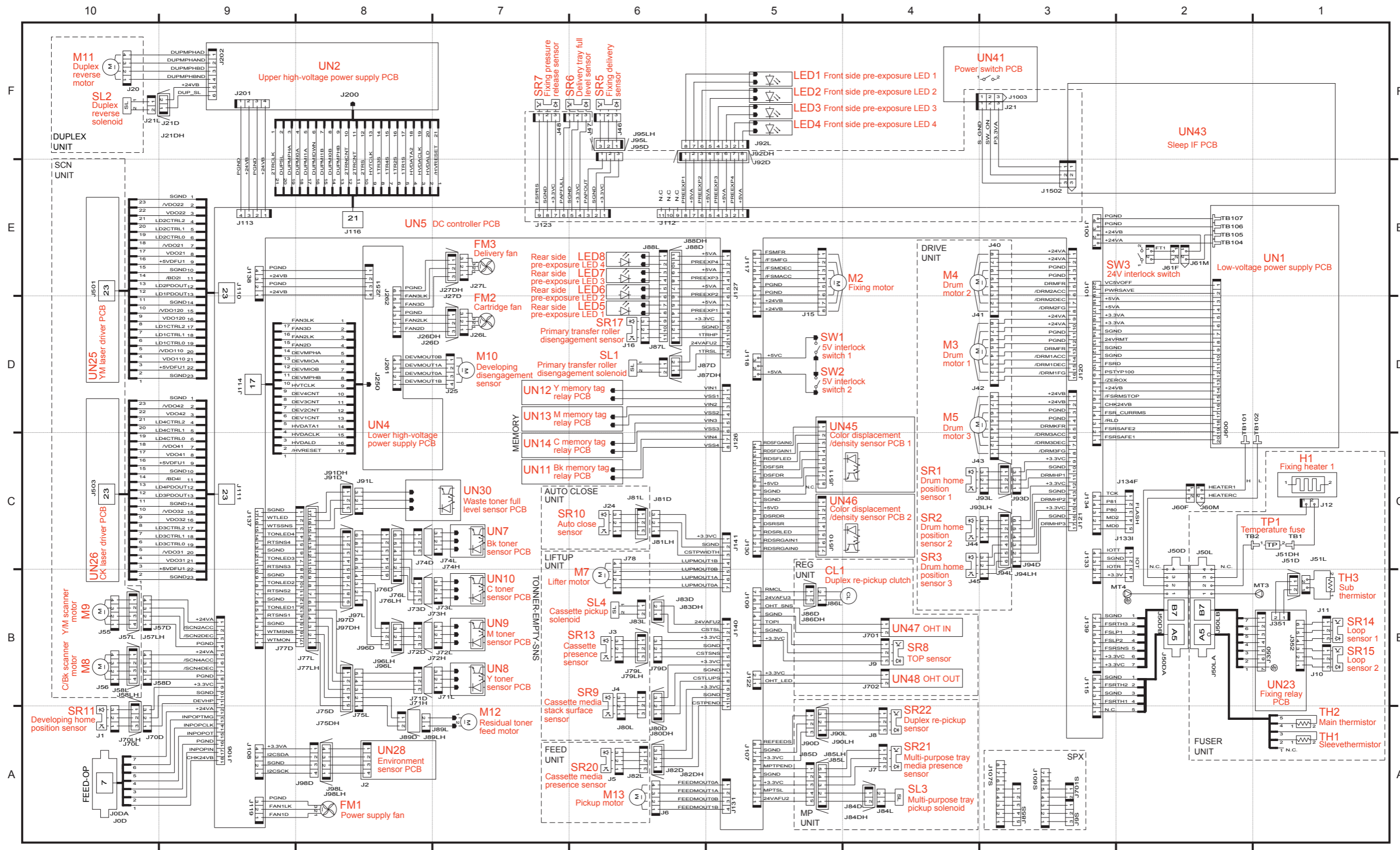

P.1

F-64

General Circuit Diagram (2/2) (LBP7780C/5480)

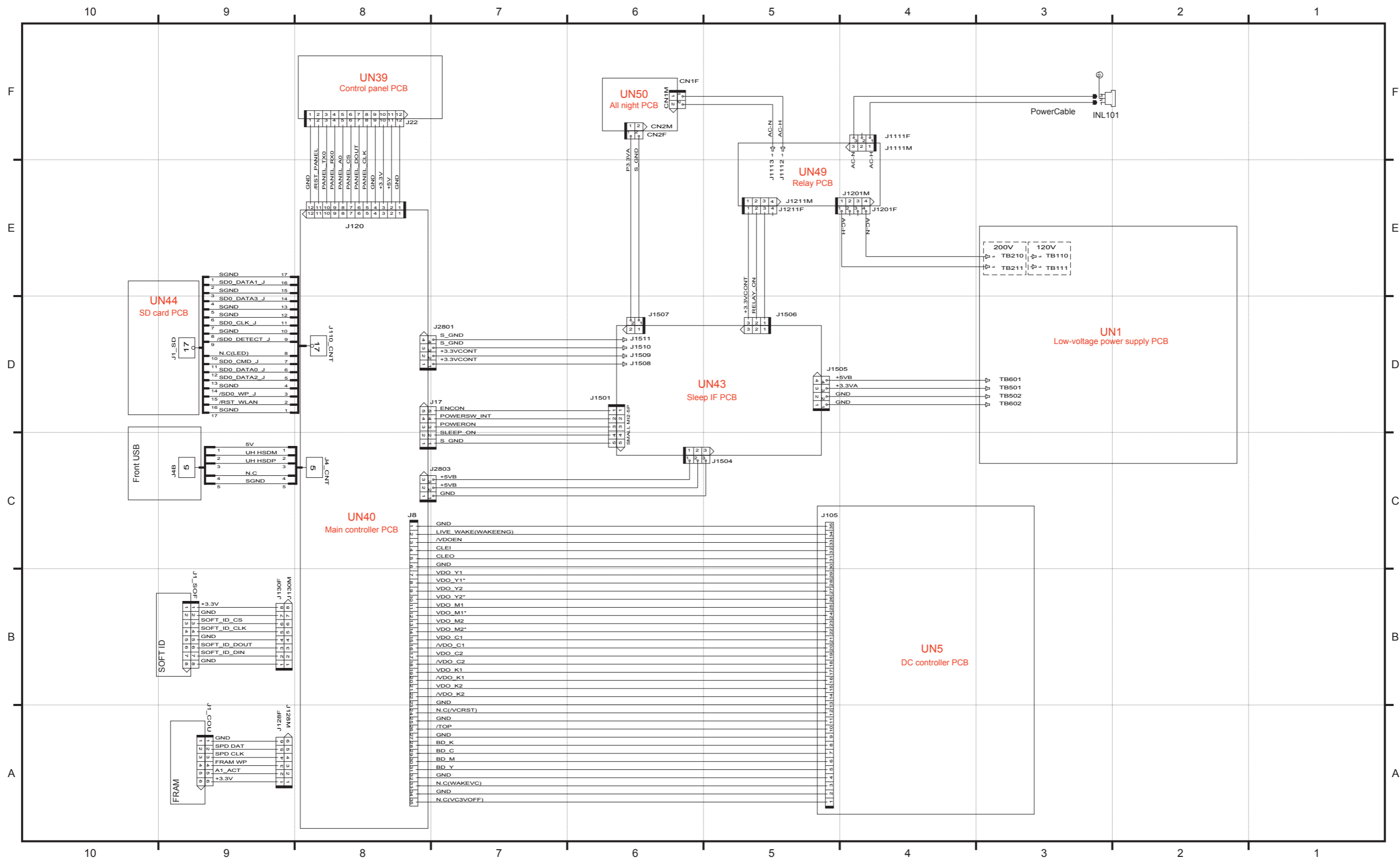

P.2

F-6-5

Appendix > General Circuit Diagram > General Circuit Diagram (2/2) (LBP7780C/5480)

Appendix > General Circuit Diagram > General Circuit Diagram (2/2) (LBP7780C/5480)

Signal Input/Output List

Connector	Pin	Abbreviation	I/O	Logic	Signal name
J100	1	+24VA			
	2	+24VB			
	3	PGND			
	4	PGND			
J101	1	FSRSAFE1	O	H	Fixing heater safety circuit signal 1
	2	FSRSAFE2	O	H	Fixing heater safety circuit signal 2
	3	/RLD	O	L	Fixing relay control signal
	4	FSR_CURRMS	I	Analog	Fixing current signal
	5	+24VB			
	6	/FSRMSTOP	O	L	Fixing motor stop signal
	7	PSTYP100	I	H	Power supply voltage detection signal
	8	/ZEROX	I	Pulse	Zero cross signal
	9	SGND			
	10	FSRD1	O	H	Fixing heater control signal
	11	SGND			
	12	SGND			
	13	24VRMT	O	Pulse	24V power supply signal
	14	+3.3VF			
	15	+3.3VF			
	16	+5VA			
	17	SW_LED (Not in use)			
	18	+5VA			
	19	PWRSWON	I	H	Power switch on signal
	20	PWROFF	O	H	Power switch off signal

Connector	Pin	Abbreviation	I/O	Logic	Signal name
J105	1	AWAKE (Not in use)			
	2	SGND			
	3	/BD1O	O	Pulse	Y BD signal
	4	/BD2O	O	Pulse	M BD signal
	5	/BD3O	O	Pulse	C BD signal
	6	/BD4O	O	Pulse	Bk BD signal
	7	SGND			
	8	/TOPO	O	L	TOP signal
	9	SGND			
	10	/VCRST	O	L	RESET signal
	11	SGND			
	12	/VDO42A	I	L	Bk video signal
	13	VDO42A	I	H	Bk video signal
	14	/VDO41A	I	L	Bk video signal
	15	VDO41A	I	H	Bk video signal
	16	/VDO32A	I	L	C video signal
	17	VDO32A	I	H	C video signal
	18	/VDO31A	I	L	C video signal
	19	VDO31A	I	H	C video signal
	20	/VDO22A	I	L	M video signal
	21	VDO22A	I	H	M video signal
	22	/VDO21A	I	L	M video signal
	23	VDO21A	I	H	M video signal
	24	/VDO12A	I	L	Y video signal
	25	VDO12A	I	H	Y video signal
	26	/VDO11A	I	L	Y video signal
	27	VDO11A	I	H	Y video signal
	28	SGND			
	29	CLEO	O	H	Serial signal (send)
	30	CLEI	I	H	Serial signal (receive)
	31	VDOEN	O	H	Video enable signal
	32	ENGON (Not in use)			
	33	SGND			

Connector	Pin	Abbreviation	I/O	Logic	Signal name
J106	1	+24VA			
	2	/SCN2ACC	O	L	Scanner motor accelerating signal
	3	/SCN2DEC	O	L	Scanner motor decelerating signal
	4	PGND			
	5	+24VA			
	6	/SCN4ACC	O	L	Scanner motor accelerating signal
	7	/SCN4DEC	O	L	Scanner motor decelerating signal
	8	PGND			
	9	+3.3VS			
	10	SGND			
	11	DEVHP	I	H	Developing home position detection signal
	12	+24VA			
	13	INPOPTMG	O	H	Paper feeder pickup signal
	14	INPOPCLK	O	H	Paper feeder clock signal
	15	INPOPOT	O	H	Paper feeder command signal
	16	PGND			
	17	INPOPIN	I	H	Paper feeder status signal
	18	CHK24V			
J107	1	24VAFU2			
	2	MPTSL	O	H	Multi-purpose tray pickup solenoid control signal
	3	+3.3V			
	4	SGND			
	5	/MPTPEND	I	L	Multi-purpose tray media presence detection signal
	6	+3.3VS			
	7	SGND			
	8	REFEEDS	I	H	Duplex re-pickup signal
J108	1	I2CSCK	I	Pulse	Serial clock signal
	2	SGND			
	3	I2CSDA	I	Pulse	Serial data signal
	4	3.3V			

Connector	Pin	Abbreviation	I/O	Logic	Signal name
J109	1	+3.3VS			
	2	SGND			
	3	/TOPI	I	L	TOP signal
	4	SGND			
	5	OHT_SNS	I	Analog	OHT detection signal
	6	24VAFU3			
	7	RMCL	O	H	Duplex re-pickup clutch control signal
J110	1	SGND			
	2	/VDO22	I	L	M video signal
	3	VDO22	I	H	M video signal
	4	LD2CTRL2	O	H	M laser control signal
	5	LD2CTRL1	O	H	M laser control signal
	6	LD2CTRL0	O	H	M laser control signal
	7	/VDO21	I	L	M video signal
	8	VDO21	I	H	M video signal
	9	+5VC			
	10	SGND			
	11	/BD2I	I	Pulse	M BD signal
	12	LD2PDOUT	I	Analog	M laser current output signal
	13	LD1PDOUT	I	Analog	Y laser current output signal
	14	SGND			
	15	/VDO120	I	L	Y video signal
	16	VDO120	I	H	Y video signal
	17	LD1CTRL2	O	H	Y laser control signal
	18	LD1CTRL1	O	H	Y laser control signal
	19	LD1CTRL0	O	H	Y laser control signal
	20	/VDO110	I	L	Y video signal
	21	VDO110	I	H	Y video signal
	22	+5VC			
	23	SGND			

Connector	Pin	Abbreviation	I/O	Logic	Signal name
J111	1	SGND			
	2	/VDO42	I	L	Bk video signal
	3	VDO42	I	H	Bk video signal
	4	LD4CTRL2	O	H	Bk laser control signal
	5	LD4CTRL1	O	H	Bk laser control signal
	6	LD4CTRL0	O	H	Bk laser control signal
	7	/VDO41	I	L	Bk video signal
	8	VDO41	I	H	Bk video signal
	9	+5VC			
	10	SGND			
	11	/BD4I	I	Pulse	Bk BD signal
	12	LD4PDOUT	I	Analog	Bk laser current output signal
	13	LD3PDOUT	I	Analog	C laser current output signal
	14	SGND			
	15	/VDO32	I	L	C video signal
	16	VDO32	I	H	C video signal
	17	LD3CTRL2	O	H	C laser control signal
	18	LD3CTRL1	O	H	C laser control signal
	19	LD3CTRL0	O	H	C laser control signal
	20	/VDO31	I	L	C video signal
	21	VDO31	I	H	C video signal
	22	+5VC			
	23	SGND			
J112	1	+5VA			
	2	PREEXP4	O		Bk pre-exposure LED control signal
	3	+5VA			
	4	PREEXP3	O		C pre-exposure LED control signal
	5	+5VA			
	6	PREEXP2	O		M pre-exposure LED control signal
	7	+5VA			
	8	PREEXP1	O		Y pre-exposure LED control signal

Connector	Pin	Abbreviation	I/O	Logic	Signal name
J113	1	+24VB			
	2	PGND			
	3	+5VC			
	4	SGND			
	5	+24VB			
	6	PGND			
J114	1	/HVRESET	O	Pulse	High-voltage IC reset signal
	2	HVDALD	O	Pulse	High-voltage IC load signal
	3	HVDACLK	O	Pulse	High-voltage IC clock signal
	4	HVDATA1	O	Pulse	High-voltage IC data signal
	5	DEV1CNT	O	Pulse	Y developing bias control signal
	6	DEV2CNT	O	Pulse	M developing bias control signal
	7	DEV3CNT	O	Pulse	C developing bias control signal
	8	DEV4CNT	O	Pulse	Bk developing bias control signal
	9	HVTCLK	O	Pulse	Trans control signal
	10	DEVMPHB	O	H	Developing disengagement motor control signal
	11	DEVMIOB	O	H	Developing disengagement motor control signal
	12	DEVMIOA	O	H	Developing disengagement motor control signal
	13	DEVMPHA	O	H	Developing disengagement motor control signal
	14	FAN2D	O	H	Cartridge fan control signal
	15	FAN2LK	I	H	Cartridge fan lock signal
	16	FAN3D	O	H	Delivery fan control signal
	17	FAN3LK	I	H	Delivery fan lock signal
J115	1	N.C.			
	2	FSRTH1	I	Analog	Main thermistor temperature signal
	3	SGND			
	4	FSRTH2	I	Analog	Sub thermistor 1 temperature signal
	5	SGND			

Connector	Pin	Abbreviation	I/O	Logic	Signal name
J116	1	/HVRESET	O	Pulse	High-voltage IC reset signal
	2	HVDALD	O	Pulse	High-voltage IC load signal
	3	HVDACLK	O	Pulse	High-voltage IC clock signal
	4	HVDATA2	O	Pulse	High-voltage IC data signal
	5	1TR1S	I	Analog	Y primary transfer current signal
	6	1TR2S	I	Analog	M primary transfer current signal
	7	1TR4S	I	Analog	Bk primary transfer current signal
	8	1TR3S	I	Analog	C primary transfer current signal
	9	HVTCLK	O	Pulse	Trans control signal
	10	2TRS	I	Analog	Secondary transfer current signal
	11	2TRCNT	O	Pulse	Secondary transfer bias control signal
	12	2TRNCNT	O	Pulse	Secondary transfer bias control signal
	13	DUPMPHB	O	H	Duplex motor control signal
	14	DUPMI0B	O	H	Duplex motor control signal
	15	DUPMI1B	O	H	Duplex motor control signal
	16	DUPMIDWN	O	H	Duplex motor control signal
	17	DUPMI1A	O	H	Duplex motor control signal
	18	DUPMI0A	O	H	Duplex motor control signal
	19	DUPMPHA	O	H	Duplex motor control signal
	20	DUPSL	O	H	Duplex reverse solenoid control signal
	21	2TRCLK	O	Pulse	Secondary transfer bias control signal
J117	1	+24VB			
	2	+24VB			
	3	PGND			
	4	PGND			
	5	/FSMACC	O	L	Fixing motor accelerating signal
	6	/FSMDEC	O	L	Fixing motor decelerating signal
	7	/FSMFG	I	L	Fixing motor speed signal
	8	FSMFR	O	H	Fixing motor reverse signal
J118	1	+5VA			
	2	N.C.			
	3	+5VC			
J119	1	FAN1D	O	H	Power supply fan control signal
	2	FAN1LK	I	H	Power supply fan lock signal
	3	PGND			

Connector	Pin	Abbreviation	I/O	Logic	Signal name
J120	1	+24VA			
	2	+24VA			
	3	PGND			
	4	PGND			
	5	DRMFR	O	H	Drum motor 1, 2 reverse signal
	6	/DRM2ACC	O	L	Drum motor 2 accelerating signal
	7	/DRM2DEC	O	L	Drum motor 2 decelerating signal
	8	/DRM2FG	I	L	Drum motor 2 speed signal
	9	+24VA			
	10	+24VA			
	11	PGND			
	12	PGND			
	13	DRMFR	O		
	14	/DRM1ACC	O	L	Drum motor 1 accelerating signal
	15	/DRM1DEC	O	L	Drum motor 1 decelerating signal
	16	/DRM1FG	I	L	Drum motor 1 speed signal
J121	1	+24VB			
	2	+24VB			
	3	PGND			
	4	PGND			
	5	DRMKFR	O	H	Drum motor 3 reverse signal
	6	/DRM3ACC	O	L	Drum motor 3 accelerating signal
	7	/DRM3DEC	O	L	Drum motor 3 decelerating signal
	8	/DRM3FG	I	L	Drum motor 3 speed signal
	9	+3.3VS			
	10	SGND			
	11	DRMH1P1	I	H	Drum home position 1 detection signal
	12	+3.3VS			
	13	SGND			
	14	DRMH1P2	I	H	Drum home position 2 detection signal
	15	+3.3VS			
	16	SGND			
	17	DRMH1P3	I	H	Drum home position 3 detection signal

Connector	Pin	Abbreviation	I/O	Logic	Signal name
J122	1	OHT_LED	O	H	OHT sensor LED control signal
	2	+3.3V			
J123	1	+3.3VS			
	2	SGND			
	3	PAPOUT	I	H	Fixing delivery detection signal
	4	+3.3VS			
	5	SGND			
	6	PAPFULL	I	H	Delivery tray full level detection signal
	7	+3.3VS			
	8	SGND			
	9	FSRRS	I	H	Fixing pressure release detection signal
	J124	1	+24VA		
2		PGND			
J126	1	VIN1		H	Y memory tag communication signal
	2	VSS1		H	Y memory tag communication signal
	3	VIN2		H	M memory tag communication signal
	4	VSS2		H	M memory tag communication signal
	5	VIN3		H	C memory tag communication signal
	6	VSS3		H	C memory tag communication signal
	7	VIN4		H	Bk memory tag communication signal
	8	VSS4		H	Bk memory tag communication signal

Connector	Pin	Abbreviation	I/O	Logic	Signal name
J127	1	+5VA			
	2	PREEXP4	O	H	Bk pre-exposure LED control signal
	3	+5VA			
	4	PREEXP3	O	H	C pre-exposure LED control signal
	5	+5VA			
	6	PREEXP2	O	H	M pre-exposure LED control signal
	7	+5VA			
	8	PREEXP1	O	H	Y pre-exposure LED control signal
	9	+3.3VS			
	10	SGND			
	11	1TRHP	I	H	Primary transfer roller disengagement detection signal
	12	24VAFU2			
	13	1TRSL	O	H	Primary transfer roller disengagement solenoid control signal

Connector	Pin	Abbreviation	I/O	Logic	Signal name
J130	1	N.C.			
	2	N.C.			
	3	RDSRGAIN0	O	H	Color displacement/density sensor sensitivity signal (rear)
	4	RDSRGAIN1	O	H	Color displacement/density sensor sensitivity signal (rear)
	5	RDSRLED1	O	H	Color displacement/density sensor LED control signal (rear)
	6	DSRSR	I	Analog	Color displacement/density detection signal (rear)
	7	DSRDR	I	Analog	Color displacement/density detection signal (rear)
	8	+5VA			
	9	SGND			
	10	SGND			
	11	+5VA			
	12	DSFDR	I	H	Color displacement/density detection signal (front)
	13	DSFSR	I	H	Color displacement/density detection signal (front)
	14	RDSFLED1	O	H	Color displacement/density sensor LED control signal (front)
	15	RDSFGAIN1	O	Analog	Color displacement/density sensor sensitivity signal (front)
	16	RDSFGAIN0	O	Analog	Color displacement/density sensor sensitivity signal (front)
	17	N.C.			
	18	N.C.			
	19	N.C.			
J131	1	FEEDMOUT0A	O	H	Pickup motor control signal
	2	FEEDMOUT1A	O	H	Pickup motor control signal
	3	FEEDMOUT0B	O	H	Pickup motor control signal
	4	FEEDMOUT1B	O	H	Pickup motor control signal

Connector	Pin	Abbreviation	I/O	Logic	Signal name
J137	1	WTMON	O	H	Waste toner feed motor control signal
	2	WTMSNS	I	H	Waste toner feed motor current signal
	3	SGND			
	4	RTSNS1	I	H	Y toner level detection signal
	5	+5VA			
	6	SGND			
	7	RTSNS2	I	H	M toner level detection signal
	8	+5VA			
	9	SGND			
	10	RTSNS3	I	H	C toner level detection signal
	11	+5VA			
	12	SGND			
	13	RTSNS4	I	H	Bk toner level detection signal
	14	+5VA			
	15	WTSSNS	I	H	Waste toner full level detection signal
	16	+5VA			
	17	SGND			
J138	1	+24VB			
	2	PGND			
	3	+24VB			
	4	PGND			
J139	1	N.C.			
	2	+3.3VS			
	3	/FSRSNS	I	L	Fixing assembly presence detection signal
	4	/FSLP2	I	L	Loop volume 1 detection signal
	5	/FSLP1	I	L	Loop volume 2 detection signal
	6	FSRTH3	I	Analog	Sub thermistor 2 temperature signal
	7	SGND			

Connector	Pin	Abbreviation	I/O	Logic	Signal name
J140	1	OUTA	O	H	Lifter motor control signal
	2	OUT/A	O	H	Lifter motor control signal
	3	+3.3V			
	4	SGND			
	5	CSTSNS	I	H	Cassette presence detection signal
	6	+3.3VS			
	7	SGND			
	8	CSTLUPS	I	H	Cassette media surface detection signal
	9	+3.3VS			
	10	SGND			
	11	CSTPEND	I	H	Cassette media presence detection signal
	12	24VAFU2			
	13	CSTSL	O	H	Cassette pickup solenoid control signal
J143	1	PGND			
	2	CHK24V			

T-6-1

Backup Data

Data to Be Stored	Data Location	Replacement		Delete									User Backup			Service Backup						
		When Replacing Main PCB	DC Controller PCB	User function					Service function				Can Data Be Backed up?	Method	Location to Be Stored	Can Data Be Backed up?	Method 1	Location to Be Stored	Method 2	Location to Be Stored		
				Initializing the [Setup] Menu(Settings)	Initializing the Network Settings(Settings)	IPSec Policy settings delete*1	SD Card Data All Erase Function	(Fixing unit/ITB unit) Initializing the Service counter	NVRAM initialization Initializing the [Setup] Menu	DC Controller PCB NVRAM Clear	E-RDS > CLEAR	CA-KEY										
Control Panel set value (Except in network and IPSec Policy Settings*1)	Main Controller PCB	Clear	-	Clear	-	-	-	/	Clear	-	-	-	-	Yes	Setup > User Maintenance > IMPORT/EXPORT > EXPORT	USB memory	Yes	FUNCTION GR. > ECONF > EXPORT ALL(GENERAL/DEPEND/SECURITY)	USB memory	Sublog Expansion Board	Sublog Board	
Control Panel set value(Network)		Clear	-	-	Clear	-	-	/	-	-	-	-	-	-	-	-	-	-	-	-	-	
Control Panel set value(IPSec Policy Settings) *1		Clear	-	-	-	Clear	-	/	-	-	-	-	-	No	-	-	No	-	-	-	-	
SSL Keys		Clear	-	-	-	-	-	/	-	-	-	-	-	No	-	-	No	-	-	-	-	
CA Certificates		Clear	-	-	-	-	-	/	-	-	-	-	-	No	-	-	No	-	-	-	-	
MEAP(Application/Settings/Data)		Clear	-	-	-	-	-	/	-	-	-	-	-	No	-	-	No	-	-	-	-	
e-RDS		Clear	-	-	-	-	-	/	-	-	Clear *3	-	-	Yes *4	Setup > User Maintenance > IMPORT/EXPORT > EXPORT	USB memory	Yes	FUNCTION GR. > ECONF > EXPORT ALL(GENERAL/DEPEND/SECURITY)	USB memory	Sublog Expansion Board	Sublog Board	
Service DATA(Main Controller PCB)		Clear	-	-	-	-	-	/	-	-	Clear *3	-	-	-	-	-	-	-	-	-	-	
DC Controller PCB NVRAM Backup(Main Controller PCB)		Clear	-	-	-	-	-	/	-	Clear	-	-	-	No	-	-	No	*6	-	-	-	
Service DATA(DC Controller PCB)	DC Controller PCB	-	Clear	-	-	-	-	/	-	-	-	-	-	No	-	-	Yes	*6	Main Controller PCB	-	-	
Main Controller service counter *2	Main Controller PCB	/	/	/	/	/	/	/	/	/	/	/	/	/	/	/	/	/	/	/	/	/
Stored Job	SD Card	-	-	-	-	-	Clear	/	-	-	-	-	-	No	-	-	No	-	-	-	-	

T-6-2

*1. To delete IPSec Policy settings, select the following in service mode: Network.gr >IPSEC SETTING > SPDALDEL.

*2. It belongs to counter gr. in service mode. Since counter gr. items are not available with this model, it is not applicable.

*3. It is initialized by selecting the following in service mode: Network gr. > E-RDS > CLEAR.

*4. Service mode setting values are stored in NVRAM. When importing/exporting user settings, the service mode items are included.

*5. It is initialized by selecting the following in service mode: Network gr. > CA-KEY.

*6. If setting information of the DC Controller PCB does not exist on the Main Controller PCB, automatic backup is performed.

If DC Controller PCB setting value already exists when installing the Main Controller PCB, automatic backup is not performed.

In service mode, clear DC Controller PCB NVRAM. Automatic backup is performed at next startup. FUNCTION GR. > CLEAR DCON (initialization of the backup area of the DC Controller PCB NVRAM)

When replacing the DC Controller PCB, restore backup information by selecting the following: FUNCTION GR. > RESTOR DCON.

