

imageCLASS LBP6200d

PARTS CATALOG



Canon

December 11, 2013
Rev. 0

PREFACE

This Parts Catalog contains listings of parts used

Diagrams are provided with the listings to aid the service technician in identifying clearly, the item to be ordered.

Whenever ordering parts, consult this Parts Catalog for all of the information pertaining to each item. Be sure to include, in the Parts Request, the full item description, the item part number, and the quantity.

COPYRIGHT (C) 1999 CANON INC.

Use of this manual should be strictly supervised to avoid disclosure of confidential information.

Contents

NUMERICAL INDEX

LBP6200/6200d(Numerical Index).....	1-1
-------------------------------------	-----

LBP6200/6200d(Parts Catalog)

001	ACCESSORIES	2-1
100	EXTERNAL COVERS, PANEL, ETC.	2-3
101	INTERNAL COMPONENTS 1	2-5
102	INTERNAL COMPONENTS 2	2-7
103	INTERNAL COMPONENTS 3	2-9
ZZA	MECHANICAL STANDARD PARTS (HOW TO USE)	2-11
ZZB	MECHANICAL STANDARD PARTS (SCREWS)	2-12
ZZC	MECHANICAL STANDARD PARTS (BOLTS)	2-19
ZZD	MECHANICAL STANDARD PARTS (NUTS)	2-20
ZZE	MECHANICAL STANDARD PARTS (RETAINING RINGS)	2-21

NUMERICAL INDEX

LBP6200/6200d(Numerical Index)

PARTS NUMBER	FIGURE & KEY NO.	PARTS NUMBER	FIGURE & KEY NO.	PARTS NUMBER	FIGURE & KEY NO
FC5-4822-000	100 - 1	RM1-7544-000	103 - 4		
FC9-5369-000	100 - 2	RM1-7546-000	101 - 1		
FC9-9575-000	100 - 3	RM1-7547-010	101 - 1		
FC9-9602-000	100 - 1	RM1-7560-000	103 - 1		
FK2-9583-000	001 - 4	RM1-7620-000	103 - 5		
FK3-1130-000	001 - 6	RM1-7739-000	103 - 3		
FK3-1228-000	001 - 3	RU6-0016-000	103 - 12		
FK3-1230-000	001 - 5	XA9-1418-000	100 - 11		
FM0-2699-000	001 - 1	XA9-1418-000	101 - 10		
FM0-2700-000	001 - 1	XA9-1418-000	103 - 9		
FM0-4722-000	001 - 1	XA9-1420-000	101 - 9		
FM4-5811-000	100 - 4	XA9-1670-000	101 - 11		
FM4-5812-000	100 - 5	XA9-1670-000	102 - 4		
FM4-5813-000	100 - 6	XA9-1670-000	103 - 10		
FM4-5814-000	100 - 7	XA9-1832-000	103 - 11		
FM4-5815-000	100 - 8	XA9-1834-000	100 - 12		
FM4-5816-000	100 - 9				
FM4-5865-000	100 - 10				
FM4-5866-000	102 - 1				
FM4-5869-000	101 - 1				
FM4-5870-000	100 - 9				
FM4-5871-000	100 - 9				
FM4-6984-000	101 - 5				
FM4-7041-000	101 - 2				
FM4-7042-000	101 - 2				
FM4-7044-000	102 - 7				
FM4-7045-000	103 - 2				
FM4-7182-000	101 - 3				
FM4-7183-000	101 - 3				
FM4-7184-010	101 - 3				
FM4-7757-000	001 - 1				
NPN	001 -				
NPN	100 -				
NPN	101 -				
NPN	102 -				
NPN	103 -				
RC2-9208-000	101 - 8				
RC2-9214-000	101 - 12				
RC2-9425-000	103 - 8				
RC2-9512-000	101 - 6				
RH9-1169-000	001 - 7				
RK2-0420-000	103 - 6				
RK2-1302-000	001 - 2				
RK2-3438-000	103 - 7				
RL1-1497-000	102 - 5				
RM1-4023-000	102 - 2				
RM1-4227-000	102 - 3				
RM1-7440-000	101 - 4				
RM1-7525-000	102 - 6				
RM1-7531-010	101 - 7				
RM1-7541-010	101 - 5				
RM1-7542-010	101 - 5				

LBP6200/6200d(Parts Catalog)

Satera LBP6200

100V JP	F15-8311-000	MHGA
---------	--------------	------

LASER SHOT LBP6200d

120V US	F15-8331-000	MHHA
---------	--------------	------

230V ASIA,KR	F15-8341-000	MHKA
--------------	--------------	------

230V AU	F15-8341-000	MHMA
---------	--------------	------

230V CN	F15-8351-000	MHLA
---------	--------------	------

i-SENSYS LBP6200d

230V EUR	F15-8391-000	MHJA
----------	--------------	------

Contents

001	ACCESSORIES	2-1
100	EXTERNAL COVERS, PANEL, ETC.	2-3
101	INTERNAL COMPONENTS 1	2-5
102	INTERNAL COMPONENTS 2	2-7
103	INTERNAL COMPONENTS 3	2-9
ZZA	MECHANICAL STANDARD PARTS (HOW TO USE)	2-11
ZZB	MECHANICAL STANDARD PARTS (SCREWS).....	2-12
ZZC	MECHANICAL STANDARD PARTS (BOLTS).....	2-19
ZZD	MECHANICAL STANDARD PARTS (NUTS).....	2-20
ZZE	MECHANICAL STANDARD PARTS (RETAINING RINGS)	2-21

FIGURE 001 ACCESSORIES

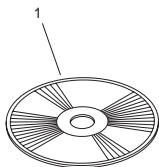

ASIA,AU,CN

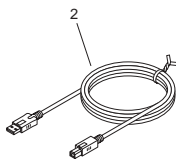

100V

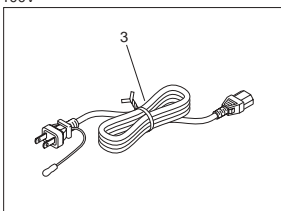

120V

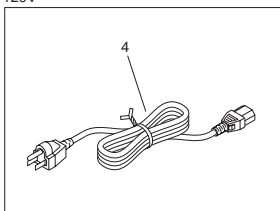

230V ASIA, EUR

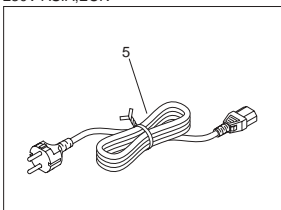

230V CN

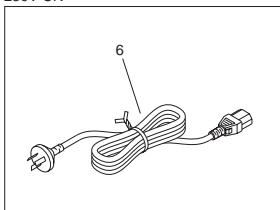

230V AU

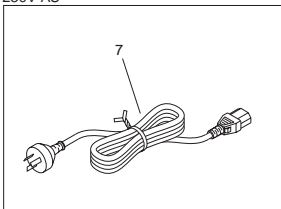

FIGURE & KEY NO.	PARTS NUMBER	RANK	Q'TY	DESCRIPTION	SERIAL NUMBER/REMARKS	SVC
Fig.001	NPN		RF	ACCESSORIES		
1	FM0-2699-000		1	CD-ROM, SOFTWARE FOR USER	Satera LBP6200 JP	
1	FM4-7757-000		1	CD-ROM, SOFTWARE FOR USER	LASER SHOT LBP6200d AU	
1	FM0-2700-000		1	CD-ROM, SOFTWARE FOR USER	LASER SHOT LBP6200d US,ASIA,CN	
1	FM0-4722-000		1	CD-ROM, SOFTWARE FOR USER	i-SENSYS LBP6200d EUR	
2	RK2-1302-000		1	CABLE, USB HOST POWER SUPPLY	ASIA,AU,CN	
3	FK3-1228-000		1	CORD, POWER	100V	
4	FK2-9583-000		1	CORD, POWER	120V	
5	FK3-1230-000		1	CORD, POWER	230V ASIA,EUR	
6	FK3-1130-000		1	CORD, POWER	230V CN	
7	RH9-1169-000		1	POWER CORD	230V AU	

FIGURE 100
EXTERNAL COVERS, PANEL, ETC.

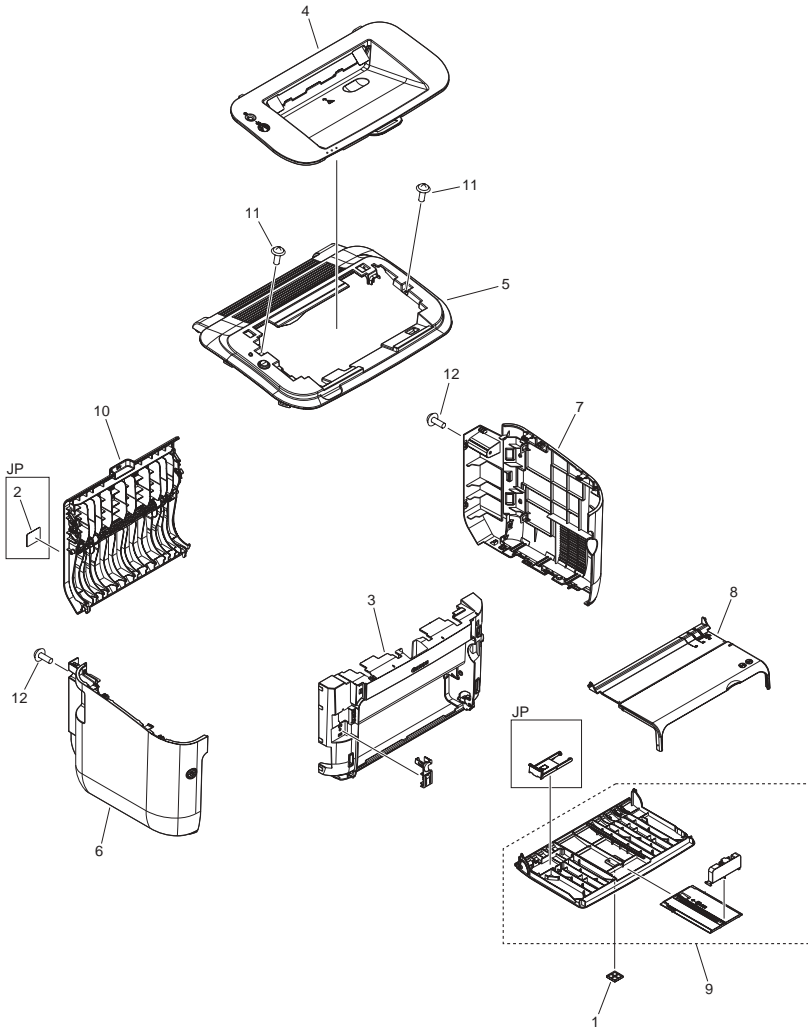

FIGURE & KEY NO.	PARTS NUMBER	R A N K	Q'TY	DESCRIPTION	SERIAL NUMBER/ REMARKS	S V C
Fig.100	NPN		RF	EXTERNAL COVERS, PANELS, ETC.		
1	FC5-4822-000		1	PLATE, NAME	Satera	
1	FC9-9602-000		1	EMBLEM, LASER SHOT	LASER SHOT,i-SENSYS	
2	FC9-5369-000		1	LABEL, GROUNDING CAUTION	JP	
3	FC9-9575-000		1	COVER, FRONT		
4	FM4-5811-000		1	CARTRIDGE DOOR ASS'Y		
5	FM4-5812-000		1	TOP COVER ASSEMBLY		
6	FM4-5813-000		1	LEFT COVER ASS'Y		
7	FM4-5814-000		1	RIGHT COVER ASS'Y		
8	FM4-5815-000		1	DUST COVER ASS'Y		
9	FM4-5816-000		1	PAPER PICK-UP TRAY ASS'Y	100V	
9	FM4-5870-000		1	PAPER PICK-UP TRAY ASS'Y	120V	
9	FM4-5871-000		1	PAPER PICK-UP TRAY ASS'Y	230V	
10	FM4-5865-000		1	DUPLEXING DOOR ASS'Y		
11	XA9-1418-000		2	SCREW, TP, M3X6		
12	XA9-1834-000		2	SCREW, D, M3X8		

FIGURE 101
INTERNAL COMPONENTS 1

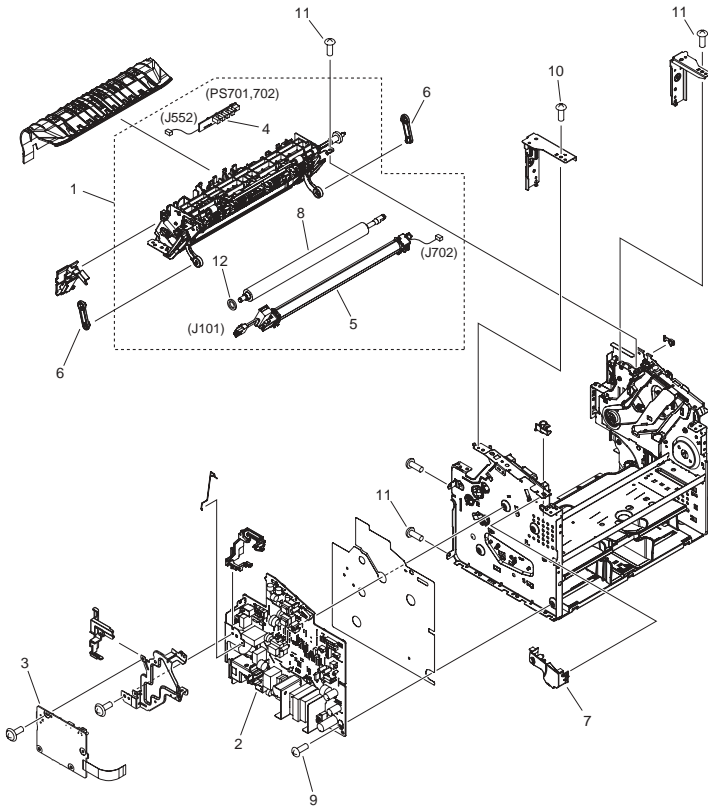

FIGURE & KEY NO.	PARTS NUMBER	R A N K	Q'TY	DESCRIPTION	SERIAL NUMBER/ REMARKS	S V C
Fig.101	NPN		RF	INTERNAL COMPONENTS 1		
1	FM4-5869-000		1	FIXING ASS'Y	100V	
1	RM1-7546-000		1	FIXING ASS'Y	120V	
1	RM1-7547-010		1	FIXING ASS'Y	230V	
2	FM4-7041-000		1	ENGINE CONTROL PCB ASS'Y	100V,120V	
2	FM4-7042-000		1	ENGINE CONTROL PCB ASS'Y	230V	
3	FM4-7182-000		1	MAIN CONTROLLER PCB ASSEMBLY	JP	
3	FM4-7183-000		1	MAIN CONTROLLER PCB ASSEMBLY	CN	
3	FM4-7184-010		1	MAIN CONTROLLER PCB ASSEMBLY	US,ASIA,AU,EUR	
4	RM1-7440-000		1	DELIVERY SENSOR PCB ASS'Y		
5	FM4-6984-000		1	FIXING FILM ASS'Y	100V	
5	RM1-7541-010		1	FIXING FILM ASS'Y	120V	
5	RM1-7542-010		1	FIXING FILM ASS'Y	230V	
6	RC2-9512-000		2	LINK, PRESSURE RELEASE		
7	RM1-7531-010		1	SWITCH LEVER ASS'Y		
8	RC2-9208-000		1	ROLLER, PRESSURE		
9	XA9-1420-000		4	SCREW, WWASHER, M3X8		
10	XA9-1418-000		7	SCREW, TP, M3X6		
11	XA9-1670-000		AR	SCREW, D, M3X6		
12	RC2-9214-000		1	SPACER, RING		

FIGURE 102 INTERNAL COMPONENTS 2

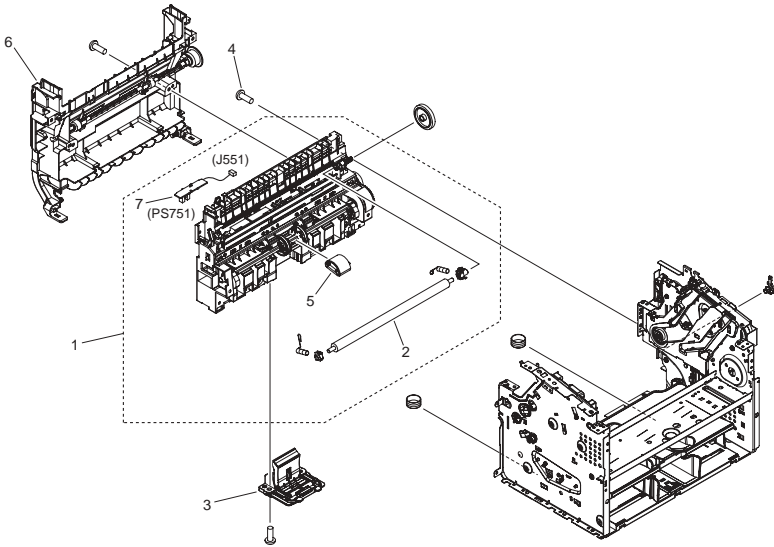

FIGURE & KEY NO.	PARTS NUMBER	RANK	Q'TY	DESCRIPTION	SERIAL NUMBER/REMARKS	SVC
Fig.102	NPN		RF	INTERNAL COMPONENTS 2		
1	FM4-5866-000		1	PAPER PICK-UP ASS'Y		
2	RM1-4023-000		1	ROLLER, TRANSFER		
3	RM1-4227-000		1	SEPARATION PAD ASS'Y		
4	XA9-1670-000		6	SCREW, D, M3X6		
5	RL1-1497-000		1	ROLLER, PICK-UP		
6	RM1-7525-000		1	DUPLEXING FRAME ASS'Y		
7	FM4-7044-000		1	PAPER PICK-UP SENSOR PCB ASS'Y		

FIGURE 103 INTERNAL COMPONENTS 3

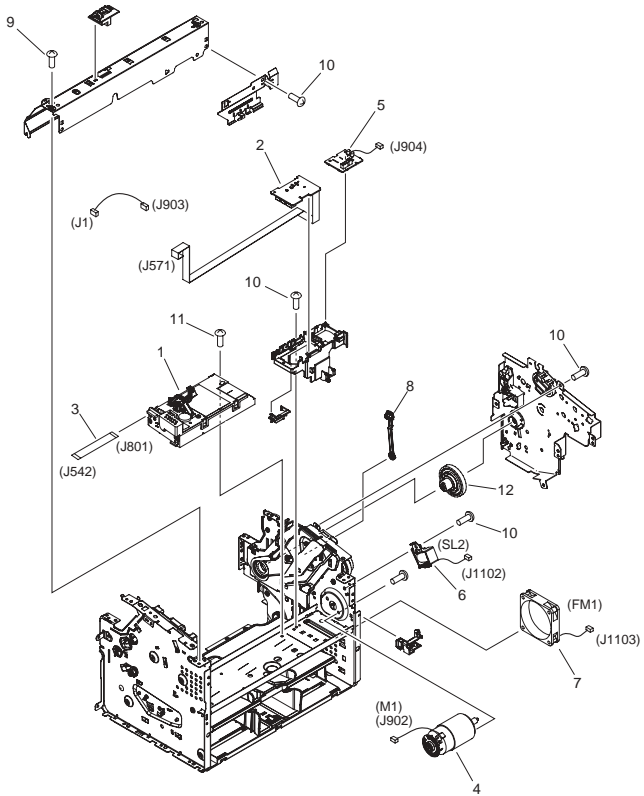

FIGURE & KEY NO.	PARTS NUMBER	R A N K	Q'TY	DESCRIPTION	SERIAL NUMBER/REMARKS	S V C
Fig.103	NPN		RF	INTERNAL COMPONENTS 3		
1	RM1-7560-000		1	LASER SCANNER ASS'Y		
2	FM4-7045-000		1	MOTOR PCB ASS'Y		
3	RM1-7739-000		1	CABLE, FLAT		
4	RM1-7544-000		1	MOTOR, DC24V		
5	RM1-7620-000		1	DUPLEXING PCB ASS'Y		
6	RK2-0420-000		1	SOLENOID		
7	RK2-3438-000		1	FAN		
8	RC2-9425-000		1	LINK, CARTRIDGE DOOR		
9	XA9-1418-000		2	SCREW, TP, M3X6		
10	XA9-1670-000		AR	SCREW, D, M3X6		
11	XA9-1832-000		4	SCREW, D, M3X10		
12	RU6-0016-000		1	GEAR, 85T		

FIGURE ZZA

MECHANICAL STANDARD PARTS (HOW TO USE)

Mechanical standard parts

機械標準部品

About a mechanical standard parts

A Mechanical standard parts is a mechanical part which not parts peculiar to a product. They are parts which are common to a Canon product and are used, such as a screw and a washer. The Fig No. and parts number of the mechanical standard parts are not listed in the product parts catalog. Refer to the parts catalog of mechanical standard parts when checking the parts number for screw or washer etc. and identify them by part shape or size.

機械標準部品とは

機械標準部品とは、製品特有の部品ではなく、ねじやワッシャなどキヤノン製品共通で使用されている機械部品（メカ部品）のことです。
製品のパーツカタログには、機械標準部品のFig No.や部品番号は記載しておりません。
ねじや、ワッシャ等の部品番号を調べるときは、機械標準部品のパーツカタログを参照し、部品の形状や大きさから判断し、使用している部品を調べてください。

Material and surface treatment of a mechanical standard parts

Material and surface treatment of mechanical standard parts are assigned commonly for each part. Refer to the Table 1 for the parts which material and surface treatment are assigned as numbers.

機械標準部品の材料および表面処理

機械標準部品の材料および表面処理については、各種部品共通で決められています。
材料および表面処理が番号で決められている部品については、表1を参照してください。

Table 1 Material and Surface treatment
表1 材料および表面処理

No. 番号	Material 材料	Surface treatment 表面処理	Color 色
1	Stainless steel ステンレス	Stainless steel black coloring (BC4) ステンレス黒着色(BC4)	Black 黒
2		not to be given なし	White 白
3	Brass 黄銅	Regular nickel plating (NL) 普通ニッケルメッキ(NL)	White 白
4		Black nickel plating (BN) 黒色ニッケルメッキ(BN)	Black 黒
5	Steel 鋼	White zinc trivalent chromate treating (ZC3) 白色亜鉛3価クロメート(ZC3)	White 白
6		Regular nickel chromium plating (NC) 普通ニッケルクロムメッキ(NC)	White 白
7		Regular nickel plating (NL) 普通ニッケルメッキ(NL)	White 白
8		Iron and steel phosphating (P1) 鉄鋼磷酸塩処理(P1)	Black 黒
9		Black zinc trivalent chromate treating (BZ3) 黒色亜鉛3価クロメート(BZ3)	Black 黒

FIGURE ZZB MECHANICAL STANDARD PARTS (SCREWS)

1. Screws ねじ

How to read Parts Numbers
部品番号の見方

Screws
ねじ

XB1-2400-609

Type No.
類別番号

Normal designation (d)
ねじの呼び(d)

Length (L)
ねじの長さ(L)

Material and Surface treatment
材料および表面処理

XB1-2 expresses Binding head machine screw.
XB1-2は、バインドねじを表す

40 expresses M4.0.
40は、M4.0を表す

0-60 expresses a length of 6.0mm.
0-60は、6.0mmの長さを表す

9 expresses Steel (Black zinc trivalent chromate treating) from Table 1.

9は、表1より鋼(黒色亜鉛3価クロメート)を表す

1-1. Cross Recessed Head Screws for Precision Equipments

精密機器用十字穴付き小ねじ

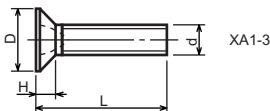
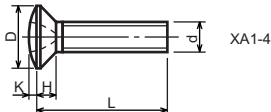
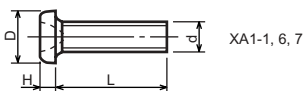

Type No. 類別番号	Type 類別	Head size (mm) 頭部寸法 (mm)							
		M1.4	M1.6	M1.7	M2	M2.5	M2.6		
XA1-1	Pan head Class 1 なべ1種	D	XA1-1	2	2.4	2.5	3	3.8	4
		H	XA1-1	0.5	0.55	0.5	0.6	0.9	0.8
XA1-3	Countersunk head Class 1 さら1種	D	XA1-3	2	2.4	2.5	3	3.8	4
		H	XA1-3	0.48	0.55	0.58	0.73	0.85	0.93
XA1-4	Oval countersunk head Class 1 丸さら1種	D	XA1-4	2	2.4	2.5	3	3.8	4
		H + K	XA1-4	0.68	0.8	0.88	1	1.25	1.3
XA1-6	Pan head Class 3 なべ3種	D	XA1-6	2.5	2.8	3	3.5	4.3	4.5
		H	XA1-6	0.8	0.85	0.9	1	1.3	1.2
XA1-7	Pan head Class 2 なべ2種	D	XA1-7	2.5	2.8	3	3.5	4.3	4.5
		H	XA1-7	0.5	0.55	0.5	0.6	0.9	0.8

1-2. Precision Tapping Screws
精密用タッピンねじ

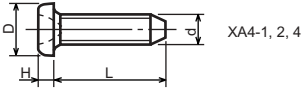

XA4-1, 2, 4

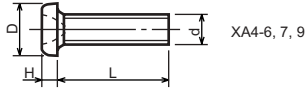

XA4-6, 7, 9

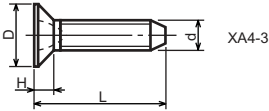

XA4-3

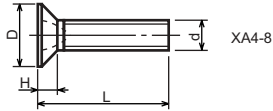

XA4-8

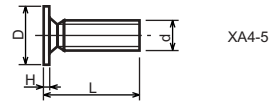

XA4-5

Type No. 類別番号	Type 類別	Head size (mm) 頭部寸法 (mm)						
		M1.4	M1.6	M1.7	M2	M2.5	M2.6	
XA4-1	With tapered end pan head Class 1 絞りなべ1種	D XA4-1	2	2.4	2.5	3	3.8	4
		H XA4-1	0.5	0.55	0.5	0.6	0.9	0.8
XA4-2	With tapered end pan head Class 3 絞りなべ3種	D XA4-2	2.5	2.8	3	3.5	4.3	4.5
		H XA4-2	0.8	0.85	0.9	1	1.3	1.2
XA4-3	With tapered end countersunk head 絞り-さら	D XA4-3	2	2.4	2.5	3	3.8	4
		H XA4-3	0.48	0.55	0.58	0.73	0.85	0.93
XA4-4	With tapered end pan head Class 2 絞りなべ2種	D XA4-4	2.5	2.8	3	3.5	4.3	4.5
		H XA4-4	0.5	0.55	0.5	0.6	0.9	0.8
XA4-5	With parallel end ultra thin head ストレート-超薄頭	D XA4-5	2.5	2.8	3	-	-	-
		H XA4-5	0.2	0.2	0.2	-	-	-
XA4-6	With parallel end pan head Class 1 ストレートなべ1種	D XA4-6	2	2.4	2.5	3	3.8	4
		H XA4-6	0.5	0.55	0.5	0.6	0.9	0.8
XA4-7	With parallel end pan head Class 3 ストレートなべ3種	D XA4-7	2.5	2.8	3	3.5	4.3	4.5
		H XA4-7	0.8	0.85	0.9	1	1.3	1.2
XA4-8	With parallel end countersunk head ストレート-さら	D XA4-8	2	2.4	2.5	3	3.8	4
		H XA4-8	0.48	0.55	0.58	0.73	0.85	0.93
XA4-9	With parallel end pan head Class 2 ストレートなべ2種	D XA4-9	2.5	2.8	3	3.5	4.3	4.5
		H XA4-9	0.5	0.55	0.5	0.6	0.9	0.8

1-3. Cross Recessed Head Screws
 一般用十字穴付き小ねじ

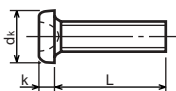

XB1-1

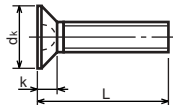

XB1-3

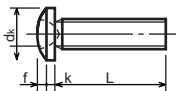

XB1-2

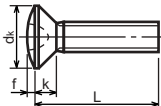

XB1-4

Type No. 類別番号	Type 類別
XB1-1	Pan head なべ
XB1-2	Binding head バインド
XB1-3	Countersunk head さら
XB1-4	Oval countersunk head 丸さら

		Head size (mm) 頭部寸法 (mm)					
		M2	M2.5	M2.6	M3	M4	M5
dk	XB1-1	3.5	4.5	4.5	5.5	7	9
k	XB1-1	1.3	1.7	1.7	2	2.6	3.3
dk	XB1-2	4.3	5.3	5.5	6.3	8.3	10.3
k+f	XB1-2	1.2	1.5	1.6	1.9	2.5	3.1
dk	XB1-3	4	5	-	6	8	10
k	XB1-3	1.2	1.45	-	1.75	2.3	2.8
dk	XB1-4	4	5	-	6	8	10
k+f	XB1-4	1.6	2	-	2.45	3.2	4
Screw part length ねじ部長さ b		8	12	12	12	16	20

1-4. Cross Recessed Head Screws with Captive Washer
 座金組込み十字穴付き小ねじ

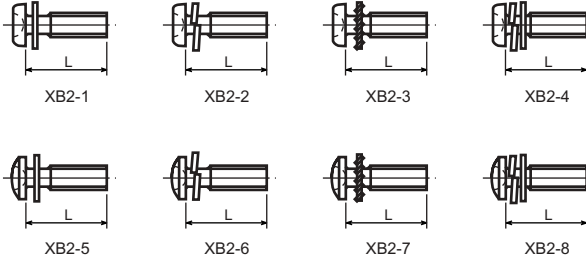

Type No. 類別番号	Type 類別
XB2-1	Pan head + Plain washer (circular bright) なべねじ+平座金
XB2-2	Pan head + Spring washer なべねじ+ばね座金
XB2-3	Pan head + Toothed lock washer なべねじ+歯付座金
XB2-4	Pan head + Spring washer and plain washer (circular bright) なべねじ+(ばね+平)座金
XB2-5	Binding head + Plain washer (circular bright) バインドねじ+平座金
XB2-6	Binding head + Spring washer バインドねじ+ばね座金
XB2-7	Binding head + Toothed lock washer バインドねじ+歯付座金
XB2-8	Binding head + Spring washer and plain washer (circular bright) バインドねじ+(ばね+平)座金

1-5. Hexagon Head Tapping Screws for Metallic Materials
 金属用六角タッピンねじ

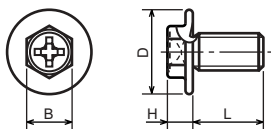

Type No. 類別番号	Type 類別	Head size (mm) 頭部寸法 (mm)	
		M3	M4
XB3-6	For metallic materials 金属用タッピン	D	8 10
		B	5.5 5.5
XB3-7	For metallic materials with clawed 金属用タッピン-つめ付き	H XB3-6	3.1 3.1
		H XB3-7	3.2 3.2

1-6. Special Tapping Screws
 特殊タッピンねじ

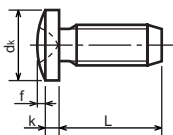

Type No. 類別番号	Type 類別	Head size (mm) 頭部寸法 (mm)	
		M3	M4
XB4-5	Binding head バインド	d _k	6.3 8.3
		k	1.3 1.7
		k+f	1.9 2.5

1-7. General Head Tapping Screws
一般用タッピンねじ

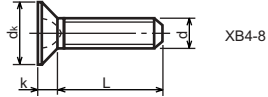
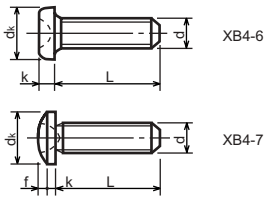

Type No. 類別番号	Type 類別	Head size (mm) 頭部寸法 (mm)						
		M2	M2.5	M2.6	M3	M4	M5	
XB4-6	Pan head なべ	d_k XB4-6	3.5	4.5	4.5	5.5	7	9
		k XB4-6	1.3	1.7	1.7	2	2.6	3.3
XB4-7	Binding head バインド	d_k XB4-7	4.3	5.3	5.5	6.3	8.3	10.3
		$k+f$ XB4-7	1.2	1.5	1.6	1.9	2.5	3.1
XB4-8	Countersunk head さら	d_k XB4-8	4	5	5.2	6	8	10
		k XB4-8	1.2	1.45	1.5	1.75	2.3	2.8

1-8. Tapping Screws for Metallic Materials
金属用タッピンねじ

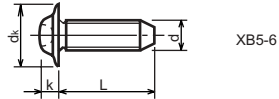
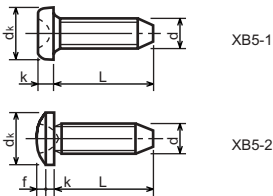

Type No. 類別番号	Type 類別	Head size (mm) 頭部寸法 (mm)					
		M2.5	M2.6	M3	M4	M5	
XB5-1	Pan head なべ	d_k XB5-1	4.5	4.5	5.5	7	9
		k XB5-1	1.7	1.7	2	2.6	3.3
XB5-2	Binding head バインド	d_k XB5-2	5.5	5.5	6.3	8.3	10.3
		$k+f$ XB5-2	1.6	1.6	1.9	2.5	3.1
XB5-6	Flanged pan head つば付きなべ	d_k XB5-6	6.5	6.5	8	10	12
		k XB5-6	2.1	2.1	1.75	3.2	4

1-9. Hexagon Socket Set Screws
六角穴付止めねじ

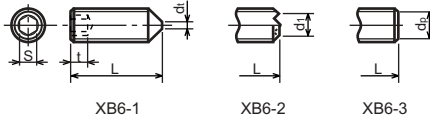

Type No. 類別番号	Type 類別	Head size (mm) 頭部寸法 (mm)							
		M1.6 M1.7	M2	M2.5 M2.6	M3	M5	M5	M6	
XB6-1	Cone point とがり先	S	0.7	0.9	1.3	1.5	2	2.5	3
		t	1.5	1.7	2	2	2.5	3	3.5
		$d_{t \max}$ XB6-1	0.4	0.5	0.65	0.75	1	1.25	1.5
		$d_{l \max}$ XB6-2	-	1.2	1.5	1.7	2.2	2.8	3.3
		$d_{l \min}$ XB6-2	-	1	1.2	1.4	1.9	2.4	2.9
		$d_{p \max}$ XB6-3	0.8	1	1.5	2	2.5	3.5	4
		$d_{p \min}$ XB6-3	0.55	0.75	1.25	1.75	2.25	3.2	3.7

1-10. Flanged Pan Head Machine Screws
つば付きなべ小ねじ

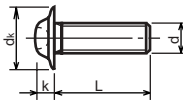

Type No. 類別番号	Type 類別	Head size (mm) 頭部寸法 (mm)					
		M2	M2.5 M2.6	M3	M5	M5	
XB6-7	Flanged pan head つば付きなべ	d_k	5	6.5	8	10	12
		k	1.7	2.1	2.5	3.2	4

FIGURE ZZC MECHANICAL STANDARD PARTS (BOLTS)

2. Bolts (Socket head cap screw) ボルト

How to read Parts Numbers
部品番号の見方

Bolt (Socket head cap screw)
ボルト

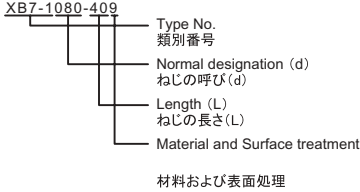

XB7-1 expresses Hexagon socket head cap screws.
XB7-1は、六角穴付きボルトを表す

080 expresses M8.0.
080は、M8.0を表す

40 expresses a length of 40mm.
40は、40mmの長さを表す

9 expresses Steel (Black zinc trivalent chromate
treating) from Table 1.

9は、表1より鋼(黒色亜鉛3価クロメート)を表す

2-1. Hexagon socket head cap screws 六角穴付きボルト

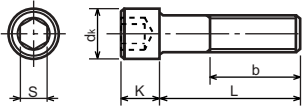

Type No. 類別番号	Type 類別
XB7-1	Hexagon socket head cap screws 六角穴付きボルト

	Head size (mm) 頭部寸法 (mm)						
	M3	M4	M5	M6	M8	M10	M12
S	2.5	3	4	5	6	8	10
d_k	5.5	7	8.5	10	13	16	18
K	3	4	5	6	8	10	12
Screw part length b_{max} ねじ部長さ b_{max}	18	20	22	24	28	32	36

FIGURE ZZD MECHANICAL STANDARD PARTS (NUTS)

3. Nuts ナット

How to read Parts Numbers
部品番号の見方

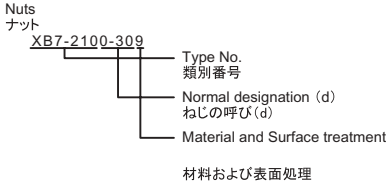

XB7-210 expresses Hexagon nut class 1.
XB7-210は、六角ナット1種を表す

0-30 expresses M3.0.
0-30は、M3.0を表す

9 expresses Steel (Black zinc trivalent chromate
treating) from Table 1.

9は、表1より鋼(黒色亜鉛3価クロメート)を表す

3-1. Hexagon Nuts and Hexagon Thin Nuts 六角ナット

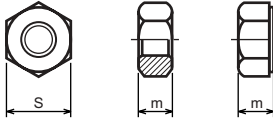

Type No. 類別番号	Type 類別
XB7-210	Hexagon nut Class 1 六角ナット-1種
XB7-220	Hexagon nut Class 3 六角ナット-3種
XB7-230	Hexagon nut Style 1 double chamfered 六角ナット-スタイル1-両面とり
XB7-231	Hexagon nut Style 1 washer faced 六角ナット-スタイル1-座付き
XB7-240	Hexagon nut Style 2 double chamfered 六角ナット-スタイル2-両面とり
XB7-241	Hexagon nut Style 2 washer faced 六角ナット-スタイル2-座付き
XB7-250	Hexagon nut 六角ナット
XB7-260	Hexagon thin nut double chamfered 六角低ナット-両面とり
XB7-270	Hexagon thin nut not chamfered 六角低ナット-面とり無し

	Head size (mm) 頭部寸法 (mm)						
	M2	M2.5	M3	M4	M5	M6	M8
S	4	5	5.5	7	8	10	13
m XB7-210	1.6	2	2.4	3.2	4	5	6.5
m XB7-220	1.2	1.6	1.8	2.4	3.2	3.6	5
m XB7-230, 231	1.6	2	2.4	3.2	4.7	5.2	6.8
m XB7-240, 241	-	-	-	-	5.1	5.7	7.5
m XB7-250	-	-	-	-	5.6	6.1	7.9
m XB7-260	1.2	1.6	1.8	2.2	2.7	3.2	4
m XB7-270	1.2	1.6	1.8	2.2	2.7	3.2	4

FIGURE ZZE MECHANICAL STANDARD PARTS (RETAINING RINGS)

5. Retaining Rings

止め輪

How to read Parts Numbers
部品番号の見方

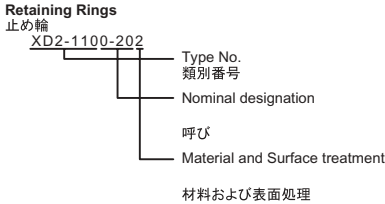

XD2-110 expresses retaining ring-E type (Type1).
XD2-110は、E形止め輪(1種)を表す

0-20 expresses a 020 of nominal designation.
(See Table 5)

0-20は、呼び020を表す(表5参照)

2 expresses Stainless steel (Surface treatment is not to be given) from Table 1.
2は、表1よりステンレス(表面処理なし)を表す

5-1. Retaining Rings - E type

E形止め輪

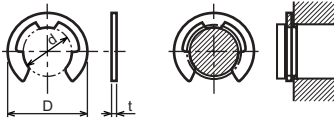

Type No. 類別番号	Type 類別
XD2-110	Retaining ring - E type (Type 1) E形止め輪(1種)
XD2-120	Retaining ring - E type (Type 2) E形止め輪(2種)

Table 5 表5

Type 種類	Nominal designation 呼び	d (mm)	D (mm)	t (mm)
Type 1 1種	007	0.65	2	0.2
	010	0.95	2.8	0.2
	013	1.25	3.3	0.3
	017	1.65	4.2	0.4
	020	1.95	4.6	0.5
	024	2.35	6	0.6
	028	2.74	6.5	0.6
	032	3.14	7.2	0.6
	037	3.64	8	0.7
	040	3.93	10	0.7
	042	4.13	10	0.7
	050	4.93	11	0.7
	058	5.73	12	0.7
	060	5.93	12.7	0.9
	064	6.32	13.5	0.9
	074	7.31	15	0.9
080	7.91	16.5	1	
Type 2 2種	008	0.8	2	0.2
	012	1.2	3	0.3
	015	1.5	4	0.4
	020	2	5	0.4
	025	2.5	6	0.4
	030	3	7	0.6
	040	4	9	0.6
	050	5	11	0.6
	060	6	12	0.8
	070	7	14	0.8
	080	8	16	0.8
	090	9	18	0.8
	100	10	20	1

5-2. Grip Rings
グリップ止め輪

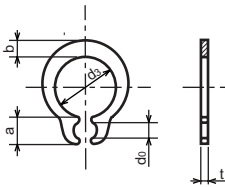

Type No. 類別番号	Type 類別
XD2-210	Grip ring グリップ止め輪

Table 5 表5

Nominal designation 呼び	d_3 (mm)	t (mm)	b (mm)	a (mm)	d_0 (mm)
020	1.9	0.5	1	1.8	0.8
025	2.35	0.5	1.2	1.9	0.9
030	2.85	0.6	1.4	1.9	0.9
035	3.3	0.6	1.6	2	0.9
040	3.8	0.8	1.8	2.8	1.2
045	4.25	0.8	2	2.9	1.3
050	4.75	0.8	2.2	2.9	1.3
060	5.7	1	2.4	3.1	1.4
070	6.7	1	2.7	3.3	1.4
080	7.7	1	3	3.5	1.4
090	8.65	1.2	3.3	4.7	1.5
100	9.65	1.2	3.5	4.7	2

5-3. Toothed Retaining Rings
歯付き形止め輪

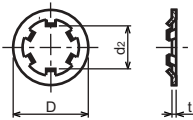

Type No. 類別番号	Type 類別
XD2-230	Toothed retaining ring 歯付き形止め輪

Table 5 表5

Nominal designation 呼び	d_z (mm)	D (mm)	t (mm)	No of teeth 歯数
015	1.4	5.2	0.25	3
020	1.9	6	0.25	3
024	2.3	6.4	0.25	3
030	2.8	8	0.25	4
040	3.8	9	0.25	4
050	4.8	10	0.25	5
060	5.8	11	0.25	5
080	7.8	13	0.25	5
100	9.8	15.4	0.25	6

5-4. Retaining Rings - C Type

C形止め輪

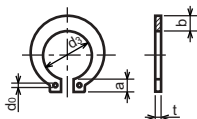

Type No. 類別番号	Type 類別
XD2-310	Retaining ring - C type for shaft C形止め輪 軸用

Table 5 表5

Nominal designation 呼び	d ₃ (mm)	t (mm)	b (mm)	a (mm)	d ₀ (mm)
010	9.3	1	1.6	3	1.2
012	11.1	1	1.8	3.2	1.5
014	12.9	1	2	3.4	1.7
015	13.8	1	2.1	3.5	1.7
016	14.7	1	2.2	3.6	1.7
017	15.7	1	2.2	3.7	1.7
018	16.5	1.2	2.6	3.8	1.7
020	18.5	1.2	2.7	3.9	2
022	20.5	1.2	2.7	4.1	2
025	23.2	1.2	3.1	4.3	2
028	25.9	1.5	3.1	4.6	2
030	27.9	1.5	3.5	4.8	2
032	29.6	1.5	3.5	5	2.5
035	32.2	1.5	4	5.4	2.5

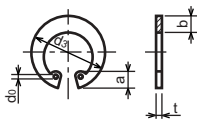

Type No. 類別番号	Type 類別
XD2-320	Retaining ring - C type for hole C形止め輪 穴用

Table 5 表5

Nominal designation 呼び	d ₃ (mm)	t (mm)	b (mm)	a (mm)	d ₀ (mm)
010	10.7	1	1.8	3.1	1.2
011	11.8	1	1.8	3.2	1.2
012	13	1	1.8	3.3	1.5
014	15.1	1	2	3.6	1.7
016	17.3	1	2	3.7	1.7
018	19.5	1	2.5	4	1.7
019	20.5	1	2.5	4	2
020	21.5	1	2.5	4	2
022	23.5	1	2.5	4.1	2
025	26.9	1.2	3	4.4	2
028	30.1	1.2	3	4.6	2
030	32.1	1.2	3	4.7	2
032	34.4	1.2	3.5	5.2	2.5
035	37.8	1.5	3.5	5.2	2.5
037	39.8	1.5	3.5	5.2	2.5
040	43.5	1.8	4	5.7	2.5
042	45.5	1.8	4	5.8	2.5
045	48.5	1.8	4.5	5.9	2.5
047	50.5	1.8	4.5	6.1	2.5
050	54.2	2	4.5	6.5	2.5
052	56.2	2	5.1	6.5	2.5
055	59.2	2	5.1	6.5	2.5
060	64.2	2	5.1	6.8	2.5
062	66.2	2	5.5	6.9	2.5
068	72.5	2.5	6	7.4	2.5
072	76.5	2.5	6.6	7.4	2.5
075	79.5	2.5	6.6	7.8	2.5
080	85.5	2.5	7	8	2.5
085	90.5	3	7	8	3
090	95.5	3	7.6	8.3	3
095	100.5	3	8	8.5	3

Prepared by
OIP Business Support Group
CANON INC.

Canon