

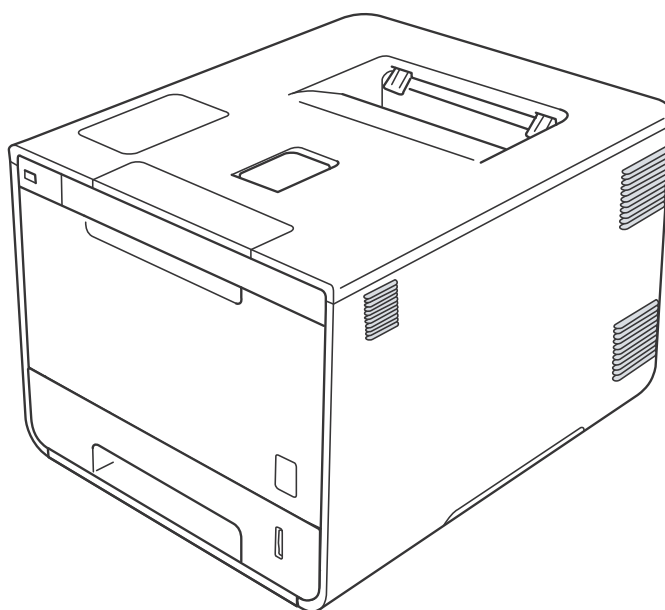

Color Laser Printer **PARTS REFERENCE LIST**

**MODEL: HL-L8250CDN/L8350CDW/
L8350CDWT/L9200CDW/L9200CDWT/
L9300CDW/L9300CDWT**



Read this list thoroughly before maintenance work.

Keep this list in a convenient place for quick and easy reference at all times.

NOTE FOR USING THIS PARTS REFERENCE LIST

1. In the case of ordering parts, it is necessary to mention the following items:

- (1) Code
- (2) Q'ty
- (3) Description

<Example>

	(1)	(2)	(3)			
REFNo.	CODE	Q'TY	DESCRIPTION	MODEL	SPEC	REMARKS

2. Design-changed parts:

If any of the parts is changed, one of the following symbols is indicated in the REMARKS column.

CHG (chg): The part is changed for a new one.

ADD (add): The part is newly added.

DEL (del): The part is deleted.

Symbol in capital letters indicates the latest parts change information in the page.

3. Parts change will be informed by the Parts change information.

4. Parts are subject to change in design without prior notice.

COUNTRIES & AREAS

ARG ---- ARGENTINA

ARL ---- AUSTRALIA

BRZ ---- BRAZIL

CAN ---- CANADA

CEE ---- CEE GENERAL

CHE ---- SWITZERLAND

CHL ---- CHILE

CHN ---- CHINA

FRA/BEL/NLD ----

FRANCE/BELGIUM/NETHERLANDS

GER ---- GERMANY

GUL ---- GULF

IBR ---- IBERIA (SPAIN & PORTUGAL)

ITA ---- ITALY

KOR ---- KOREA

PND ---- PAN-NORDIC

(NORWAY/FINLAND/DENMARK/SWEDEN)

RUS ---- RUSSIA

SGP ---- SINGAPORE

TWN ---- TAIWAN

UK ---- UNITED KINGDOM

US ---- U.S.A.

CONTENTS

1.	<u>FRAME</u>	1
2.	<u>DRIVE</u>	3
3.	<u>LASER UNIT</u>	5
4.	<u>PAPER FEEDER</u>	7
5.	<u>MP UNIT</u>	9
6.	<u>DUPLEX</u>	11
7.	<u>PAPER TRAY</u>	13
8.	<u>FUSER UNIT</u>	15
9.	<u>PAPER EJECT</u>	17
10.	<u>COVERS & LABELS</u>	19
11.	<u>PCB</u>	23
12.	<u>ACCESSORIES</u>	25
13.	<u>PACKING MATERIALS</u>	29
14.	<u>PERIODICAL MAINTENANCE PARTS</u>	32
15.	<u>LT</u>	34

1.FRAME

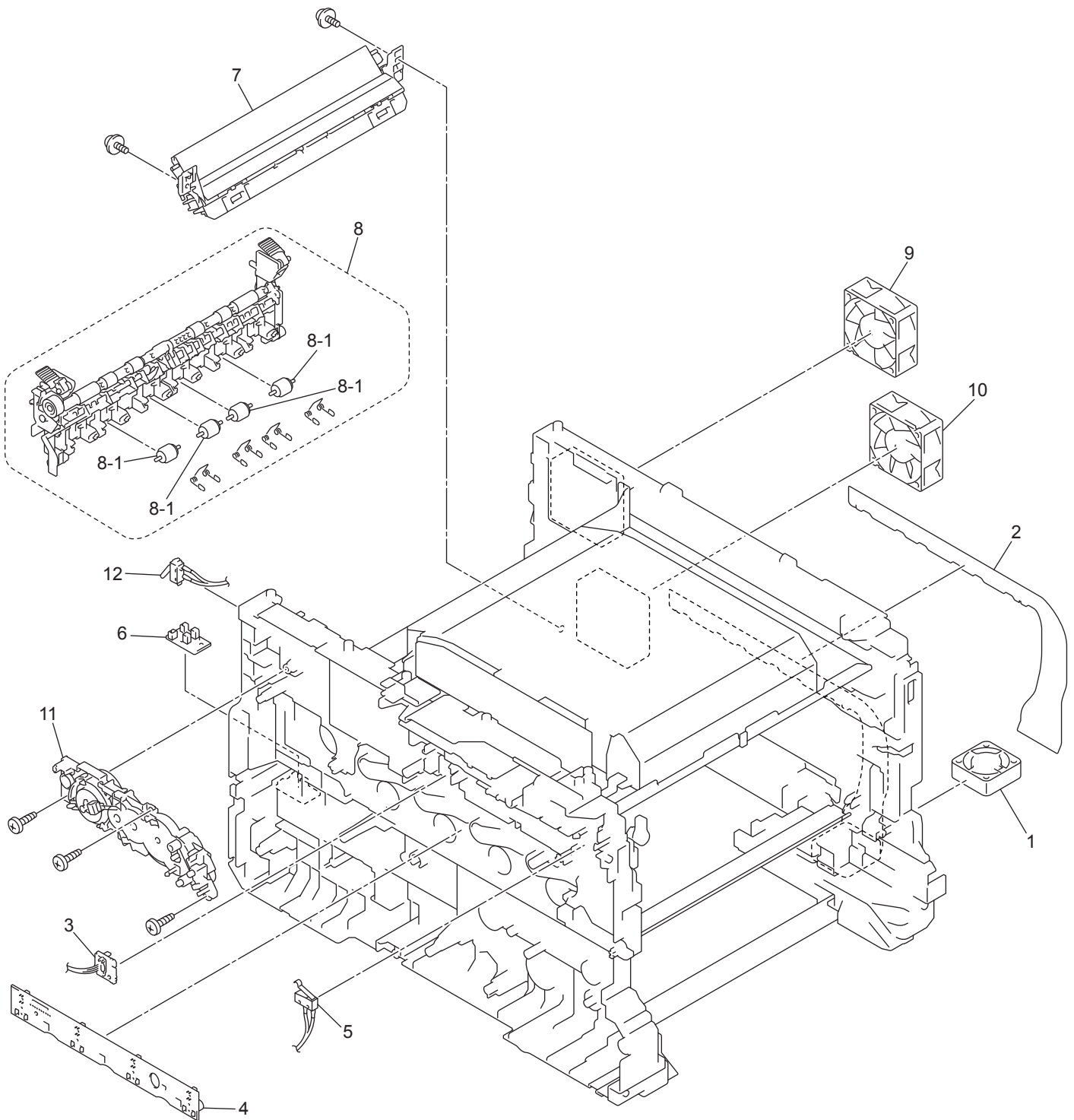

1. FRAME

REF No.	CODE	Q'TY	DESCRIPTION	MODEL	SPEC	REMARKS
1	LY0101001	1	BLOWER			
2	LY7613001	1	AIR DUCT FILM			
3	LV0489001	1	DEVELOP RELEASE SENSOR PCB ASSY			
4	LY7724001	1	TONER/NEW SENSOR PCB ASSY			
5	LV1177001	1	FRONT COVER SENSOR			
6	LV1201001	1	EJECT SENSOR PCB ASSY	HL-L8250CDN	FOR US/US_FS	
6	LV1412001	1	EJECT SENSOR PCB ASSY	HL-L8250CDN	FOR GER/UK/ARL/CHE/ITA/IBR/ CHN/SGP/KOR/RUS/FRA/BEL/ NLD/PND/CEE	
6	LV1201001	1	EJECT SENSOR PCB ASSY	HL-L8350CDW	FOR US/CAN/TWN/BRZ/US_FS	
6	LV1412001	1	EJECT SENSOR PCB ASSY	HL-L8350CDW	FOR GER/UK/ARL/CHE/ITA/IBR/ ARG/CHL/GUL/SGP/KOR/FRA/ BEL/NLD/PND/CEE	ADD
6	LV1201001	1	EJECT SENSOR PCB ASSY	HL-L8350CDWT		
6	LV1201001	1	EJECT SENSOR PCB ASSY	HL-L9200CDW	FOR US/CAN	
6	LV1412001	1	EJECT SENSOR PCB ASSY	HL-L9200CDW	FOR ARL/CHN	
6	LV1201001	1	EJECT SENSOR PCB ASSY	HL-L9200CDWT	FOR US	
6	LV1412001	1	EJECT SENSOR PCB ASSY	HL-L9200CDWT	FOR GER/UK/CHE/ITA/IBR/RUS/ FRA/BEL/NLD/PND/CEE	
6	LV1201001	1	EJECT SENSOR PCB ASSY	HL-L9300CDW		
6	LV1201001	1	EJECT SENSOR PCB ASSY	HL-L9300CDWT	FOR US	
6	LV1412001	1	EJECT SENSOR PCB ASSY	HL-L9300CDWT	FOR GER/UK/CHE/ITA/IBR/FRA/ BEL/NLD/PND	
7	LY7726001	1	REGISTRATION MARK SENSOR UNIT			
8	LY7727001	1	FUSER COVER ASSY			
8-1	LY0634001	4	CLEANER PINCH ROLLER S ASSY			
9	LY7625001	1	FUSER FAN			
10	LY7719001	1	POWER FAN			
11	LY7725001	1	DEVELOP RELEASE DRIVE UNIT			
12	LV1176001	1	BACK COVER SENSOR ASSY			

2.DRIVE

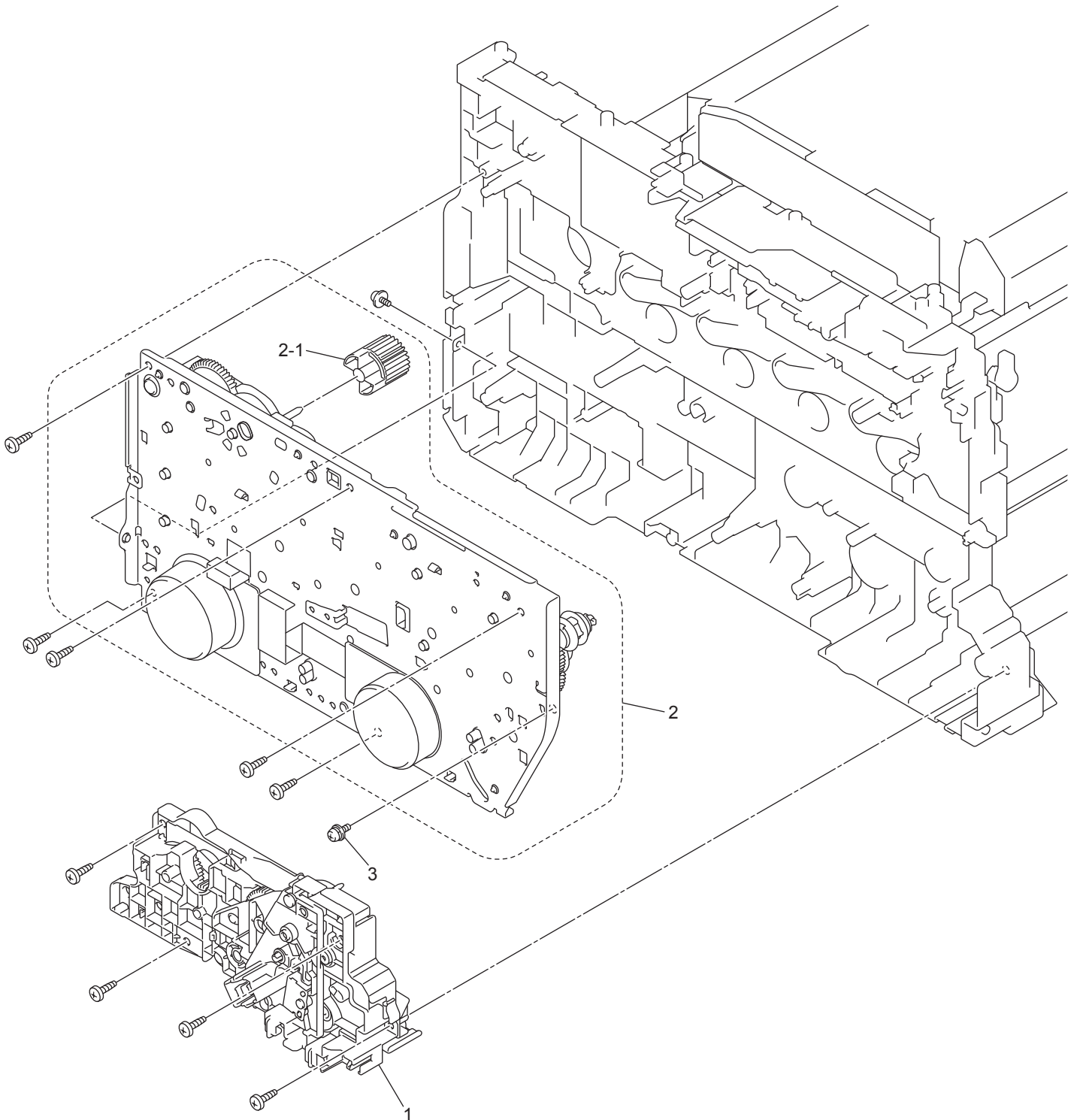

2. DRIVE

REF No.	CODE	Q'TY	DESCRIPTION	MODEL	SPEC	REMARKS
1	LY7731001	1	MAIN DRIVE UNIT			
2	LU4923001	1	PROCESS DRIVE UNIT (SP)	HL-L8250CDN		
2	LU4923001	1	PROCESS DRIVE UNIT (SP)	HL-L8350CDW		
2	LU4923001	1	PROCESS DRIVE UNIT (SP)	HL-L8350CDWT		
2	LU4923001	1	PROCESS DRIVE UNIT (SP)	HL-L9200CDW		
2	LU4923001	1	PROCESS DRIVE UNIT (SP)	HL-L9200CDWT		
2	LR2159001	1	PROCESS DRIVE UNIT (SP)	HL-L9300CDW		
2	LR2159001	1	PROCESS DRIVE UNIT (SP)	HL-L9300CDWT		
2-1	LY0233001	1	FUSER DRIVE GEAR Z25			
3	LU6109001	1	TAPTITE PAN (WASHER) B M4X12DA			

3.LASER UNIT

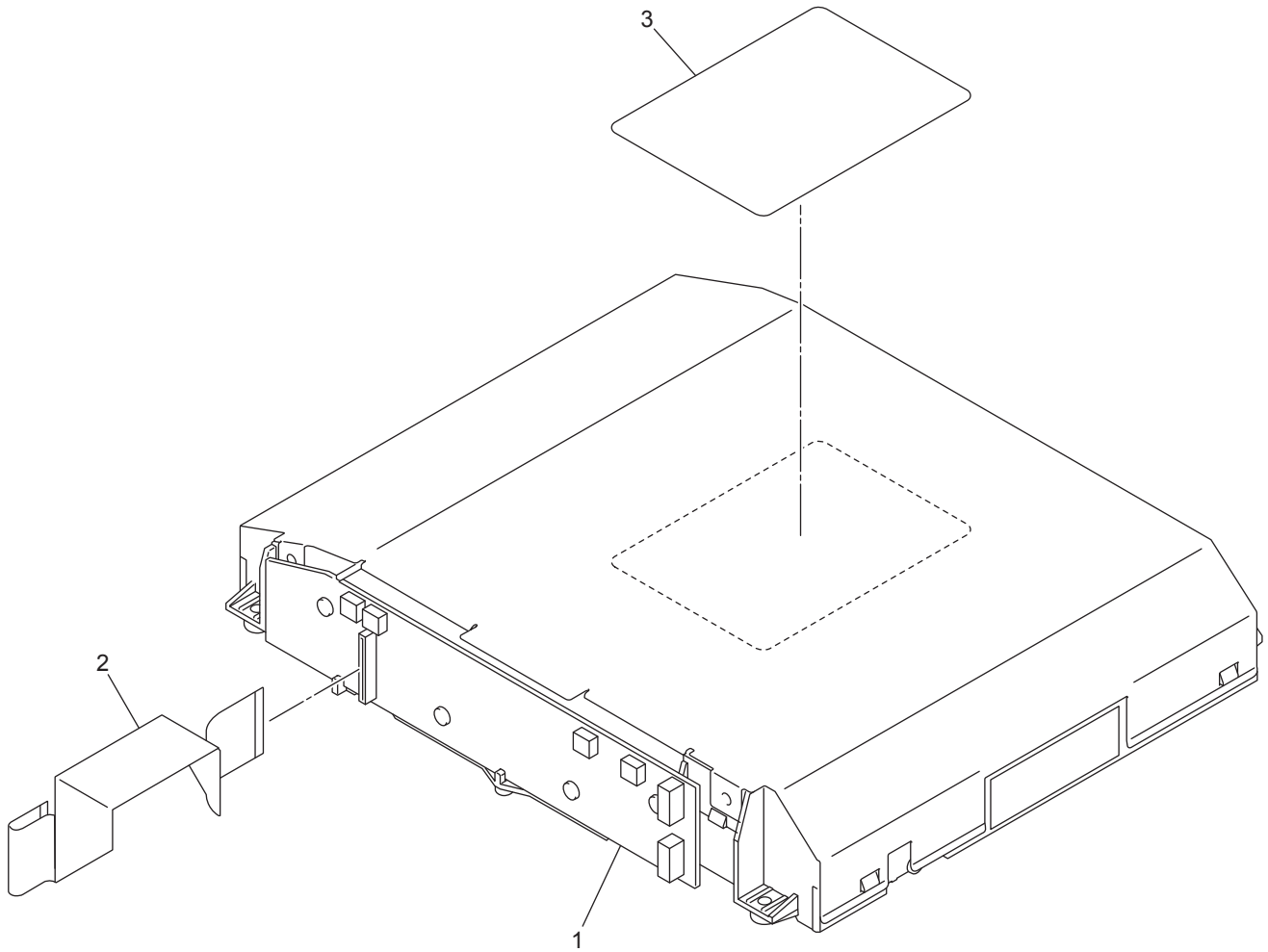

3. LASER UNIT

REF No.	CODE	Q'TY	DESCRIPTION	MODEL	SPEC	REMARKS
1	LU6918001	1	LASER UNIT (SP)			CHG
2	LV1174001	1	LASER UNIT FLAT CABLE			
3	LU1259001	1	LABEL LASER CAUTION			

4.PAPER FEEDER

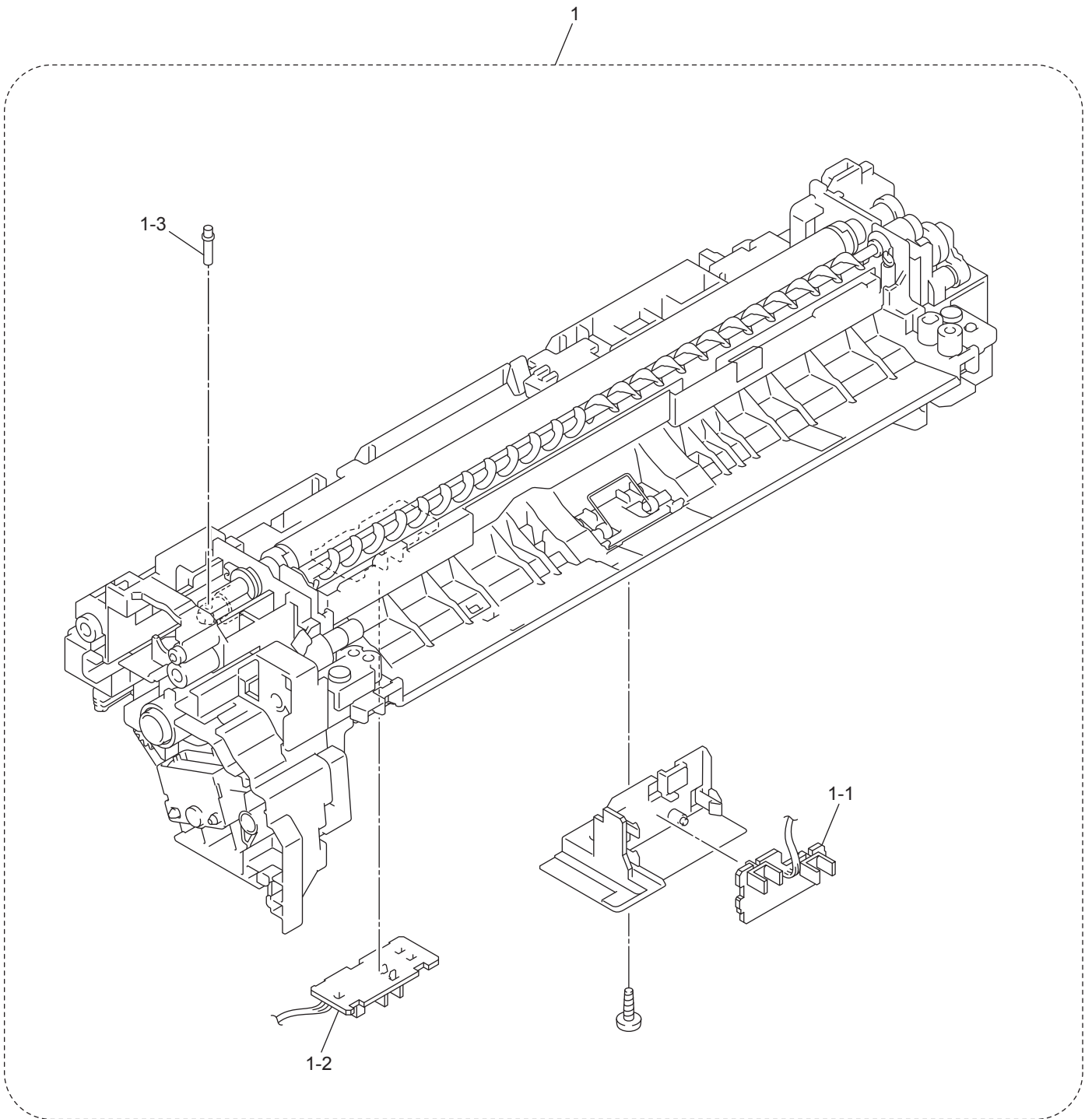

4. PAPER FEEDER

REF No.	CODE	Q'TY	DESCRIPTION	MODEL	SPEC	REMARKS
1	LR2190001	1	PAPER FEED UNIT (SP)			CHG
1-1	LV1208001	1	REGISTRATION FRONT/REAR SENSOR PCB ASSY			
1-2	LV1210001	1	T1 PAPER FEED SENSOR PCB ASSY			
1-3	LY7136001	1	JOINT PIN			ADD

5.MP UNIT

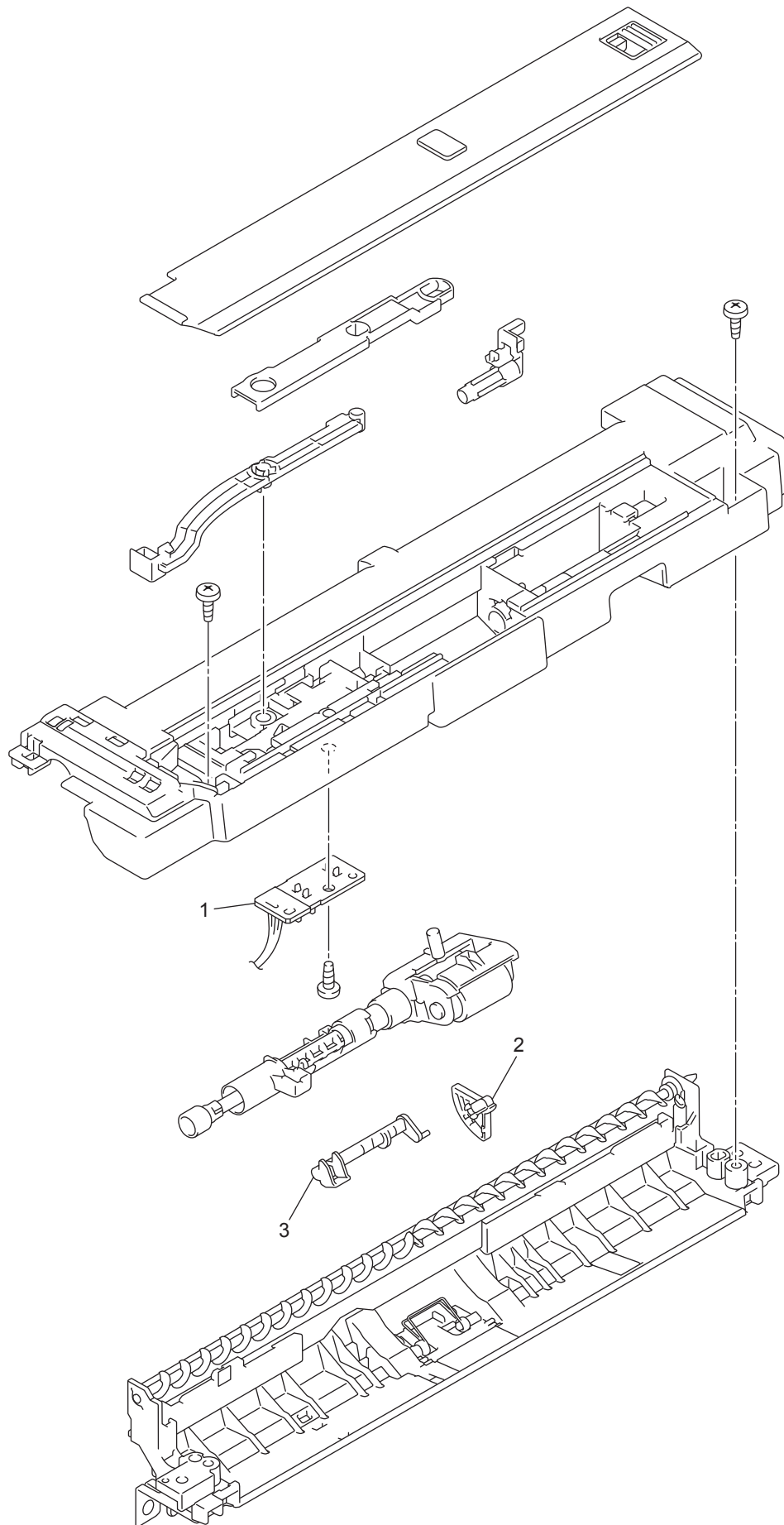

5. MP UNIT

REF No.	CODE	Q'TY	DESCRIPTION	MODEL	SPEC	REMARKS
1	LV1212001	1	MP PAPER EMPTY/REGISTRATION FRONT SENSOR PCB ASSY			
2	LY0873001	1	MP PAPER EMPTY ACUTUATOR A ASSY			
3	LY0304001	1	MP PAPER EMPTY ACUTUATOR B			

6.DUPLEX

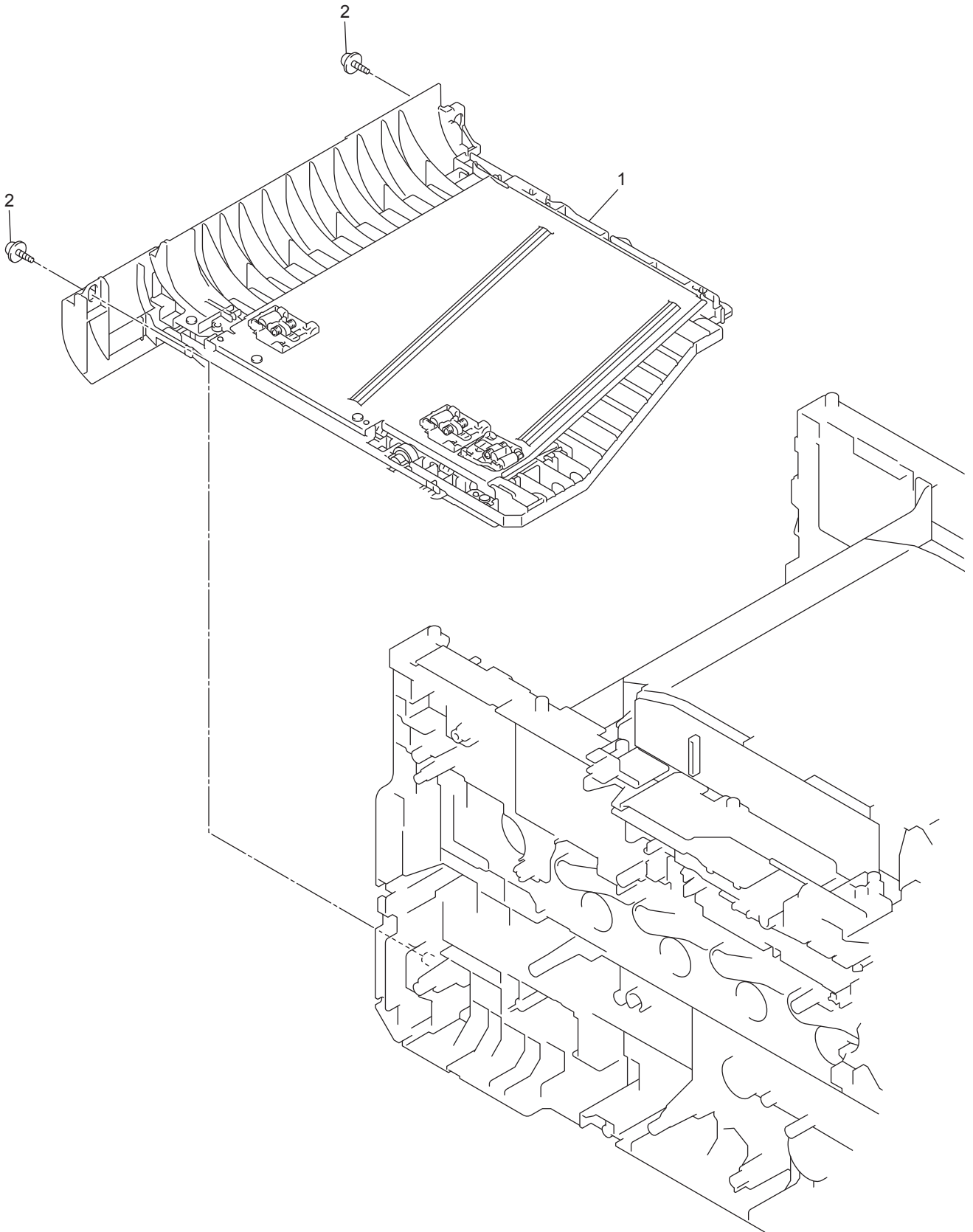

6. DUPLEX

REF No.	CODE	Q'TY	DESCRIPTION	MODEL	SPEC	REMARKS
1	LU4928001	1	DX FEED ASSY LTR (SP)	HL-L8250CDN	FOR US/US_FS	
1	LU4929001	1	DX FEED ASSY A4 (SP)	HL-L8250CDN	FOR GER/UK/ARL/CHE/ITA/IBR/ CHN/SGP/KOR/RUS/FRA/BEL/ NLD/PND/CEE	
1	LU4928001	1	DX FEED ASSY LTR (SP)	HL-L8350CDW	FOR US/CAN/ARG/CHL/BRZ/US_FS	
1	LU4929001	1	DX FEED ASSY A4 (SP)	HL-L8350CDW	FOR GER/UK/ARL/CHE/ITA/IBR/ TWN/GUL/SGP/KOR/FRA/BEL/ NLD/PND/CEE	
1	LU4928001	1	DX FEED ASSY LTR (SP)	HL-L8350CDWT		
1	LU4928001	1	DX FEED ASSY LTR (SP)	HL-L9200CDW	FOR US/CAN	
1	LU4929001	1	DX FEED ASSY A4 (SP)	HL-L9200CDW	FOR ARL/CHN	
1	LU4928001	1	DX FEED ASSY LTR (SP)	HL-L9200CDWT	FOR US	
1	LU4929001	1	DX FEED ASSY A4 (SP)	HL-L9200CDWT	FOR GER/UK/CHE/ITA/IBR/RUS/ FRA/BEL/NLD/PND/CEE	
1	LU4928001	1	DX FEED ASSY LTR (SP)	HL-L9300CDW		
1	LU4928001	1	DX FEED ASSY LTR (SP)	HL-L9300CDWT	FOR US	
1	LU4929001	1	DX FEED ASSY A4 (SP)	HL-L9300CDWT	FOR GER/UK/CHE/ITA/IBR/FRA/ BEL/NLD/PND	
2	LY1163001	2	TAPTITE CUP B M3X12			

7.PAPER TRAY

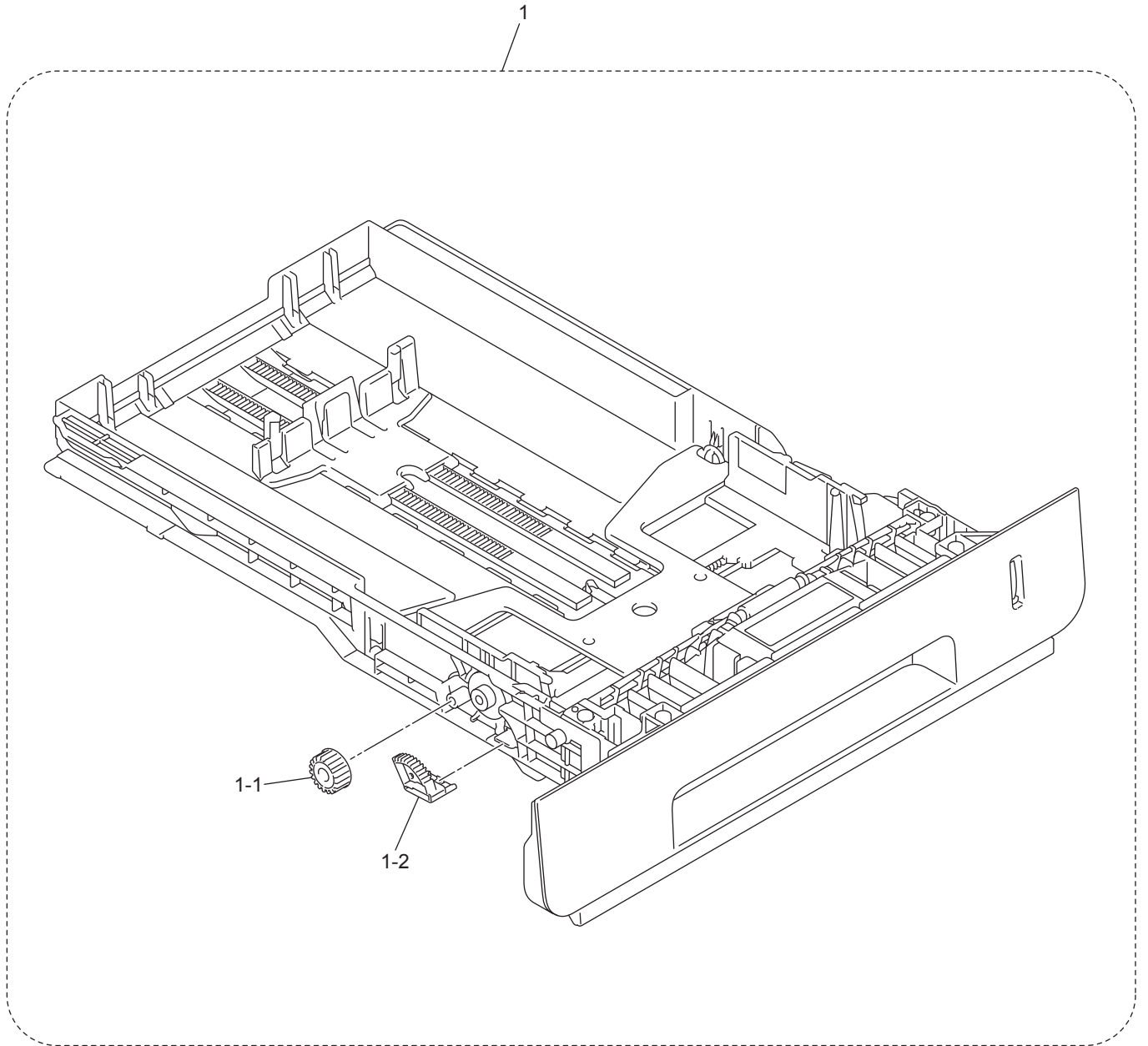

7. PAPER TRAY

REF No.	CODE	Q'TY	DESCRIPTION	MODEL	SPEC	REMARKS
1	LY7750001	1	PAPER TRAY 1	HL-L8250CDN		
1	LY7750001	1	PAPER TRAY 1	HL-L8350CDW		
1	LY7750001	1	PAPER TRAY 1	HL-L8350CDWT		
1	LY7750002	1	PAPER TRAY 1	HL-L9200CDW		
1	LY7750002	1	PAPER TRAY 1	HL-L9200CDWT		
1	LY7750002	1	PAPER TRAY 1	HL-L9300CDW		
1	LY7750002	1	PAPER TRAY 1	HL-L9300CDWT		
1-1	LR0252001	1	GEAR Z19M10			
1-2	LY2202001	1	LIFT GEAR 46			

8.FUSER UNIT

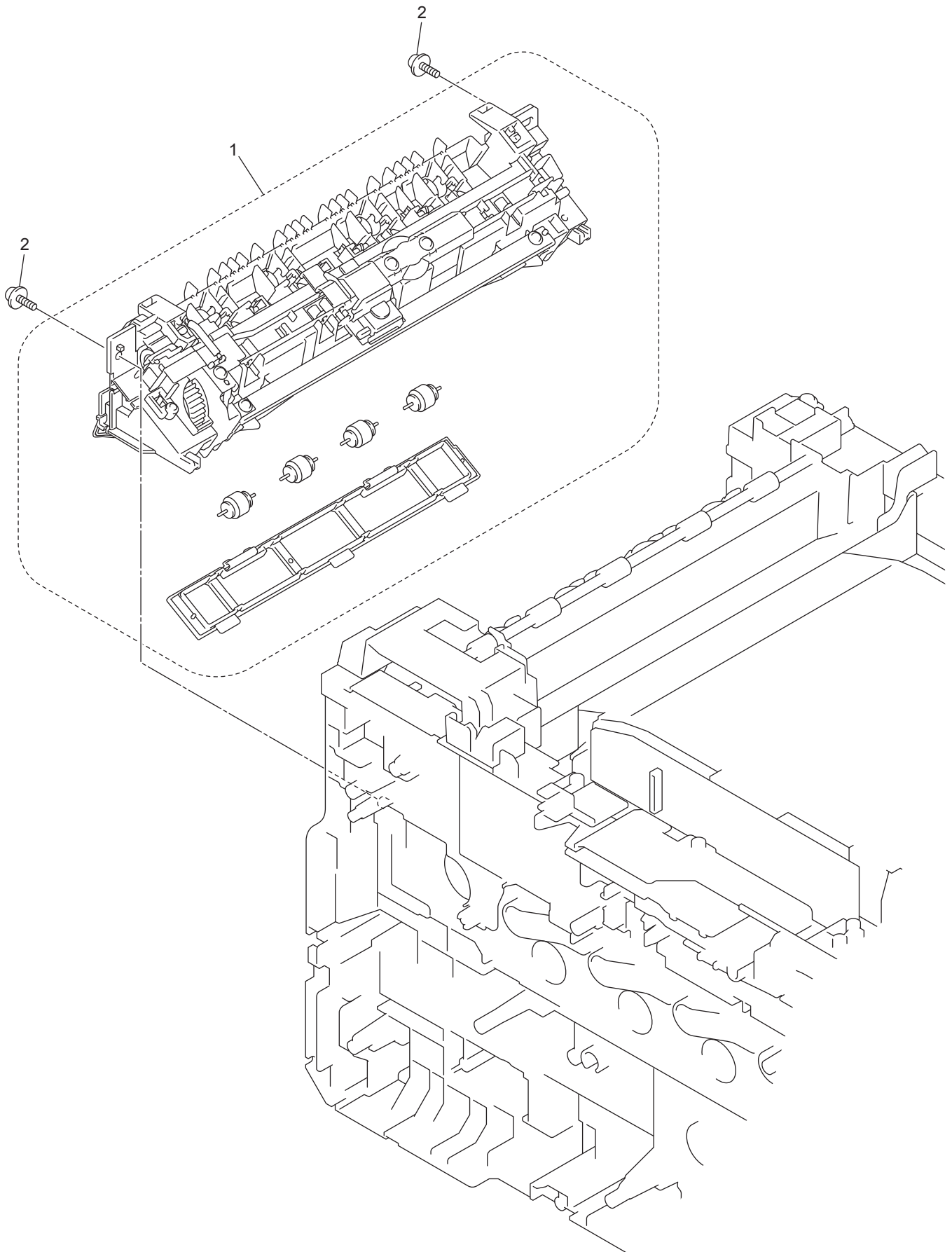

8. FUSER UNIT

REF No.	CODE	Q'TY	DESCRIPTION	MODEL	SPEC	REMARKS
1	LY7901001	1	FUSER UNIT 115V(SP)	HL-L8250CDN	FOR US/US_FS	
1	LY7902001	1	FUSER UNIT 230V(SP)	HL-L8250CDN	FOR GER/UK/ARL/CHE/ITA/IBR/ CHN/SGP/KOR/RUS/FRA/BEL/ NLD/PND/CEE	
1	LY7901001	1	FUSER UNIT 115V(SP)	HL-L8350CDW	FOR US/CAN/TWN/US_FS	
1	LY7902001	1	FUSER UNIT 230V(SP)	HL-L8350CDW	FOR GER/UK/ARL/CHE/ITA/IBR/ ARG/CHL/GUL/SGP/KOR/FRA/ BEL/NLD/PND/CEE	
1	LU4697001	1	FUSER UNIT 127V(SP)	HL-L8350CDW	FOR BRZ	
1	LY7901001	1	FUSER UNIT 115V(SP)	HL-L8350CDWT		
1	LY7901001	1	FUSER UNIT 115V(SP)	HL-L9200CDW	FOR US/CAN	
1	LY7902001	1	FUSER UNIT 230V(SP)	HL-L9200CDW	FOR ARL/CHN	
1	LY7901001	1	FUSER UNIT 115V(SP)	HL-L9200CDWT	FOR US	
1	LY7902001	1	FUSER UNIT 230V(SP)	HL-L9200CDWT	FOR GER/UK/CHE/ITA/IBR/RUS/ FRA/BEL/NLD/PND/CEE	
1	LY7901001	1	FUSER UNIT 115V(SP)	HL-L9300CDW		
1	LY7901001	1	FUSER UNIT 115V(SP)	HL-L9300CDWT	FOR US	
1	LY7902001	1	FUSER UNIT 230V(SP)	HL-L9300CDWT	FOR GER/UK/CHE/ITA/IBR/FRA/ BEL/NLD/PND	
2	LJ0395001	2	TAPTITE PAN B M4X14			

9.PAPER EJECT

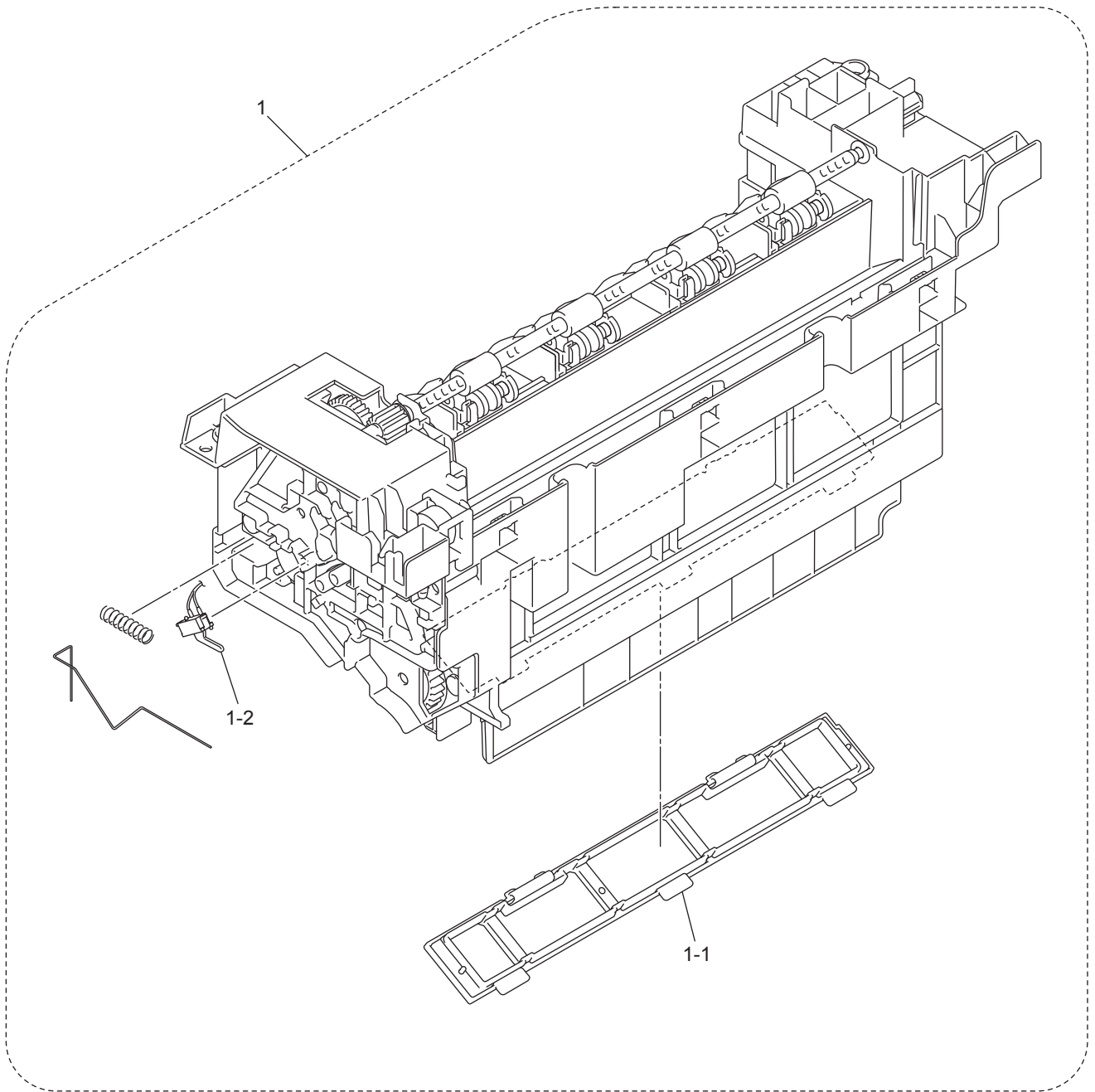

9. PAPER EJECT

REF No.	CODE	Q'TY	DESCRIPTION	MODEL	SPEC	REMARKS
1	LU4924001	1	PAPER EJECT ASSY (SP)			
1-1	LY7841001	1	TONER FILTER ASSY			
1-2	LV1282001	1	PAPER EJECT ORIGIN SENSOR			

10. COVER&LABELS

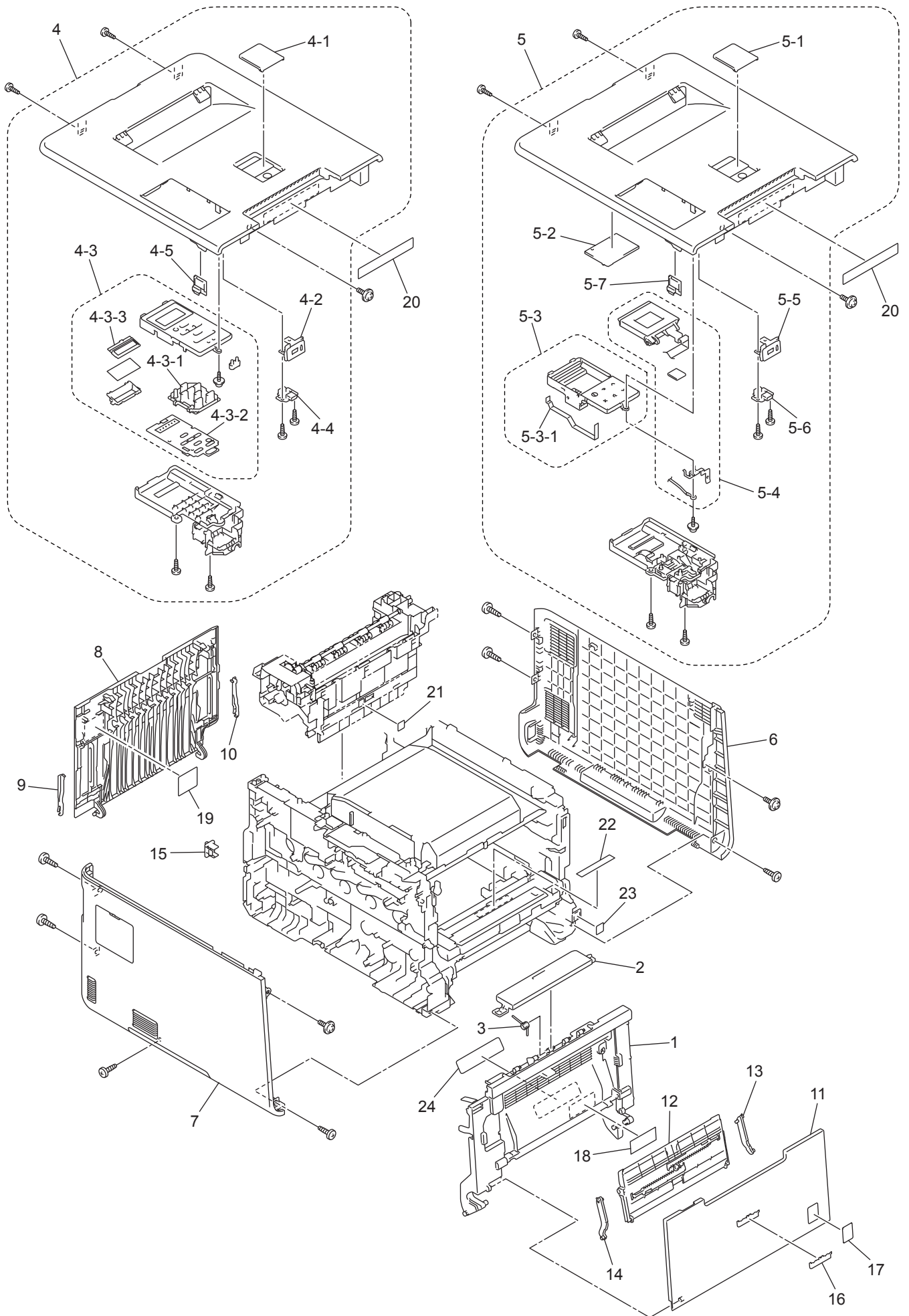

10. COVERS & LABELS

REF No.	CODE	QTY	DESCRIPTION	MODEL	SPEC	REMARKS
1	LY1859001	1	FRONT COVER	HL-L8250CDN		
1	LY1859001	1	FRONT COVER	HL-L8350CDW		
1	LY1859001	1	FRONT COVER	HL-L8350CDWT		
1	LY1859002	1	FRONT COVER	HL-L9200CDW		
1	LY1859002	1	FRONT COVER	HL-L9200CDWT		
1	LY1859002	1	FRONT COVER	HL-L9300CDW		
1	LY1859002	1	FRONT COVER	HL-L9300CDWT		
2	LY1910001	1	FRONT COVER RELEASE BUTTON			
3	LY1911001	1	FRONT COVER RELEASE BUTTON SPRING			
4	LU4925001	1	TOP COVER ASSY (SP)	HL-L8250CDN		
4	LU4926001	1	TOP COVER ASSY (SP)	HL-L8350CDW		
4	LU4926001	1	TOP COVER ASSY (SP)	HL-L8350CDWT		
4-1	LY0428003	1	SUPPORT FLAP	HL-L8250CDN		
4-1	LY0428003	1	SUPPORT FLAP	HL-L8350CDW		
4-1	LY0428003	1	SUPPORT FLAP	HL-L8350CDWT		
4-2	LY7765001	1	USB COVER PRINTED ASSY	HL-L8250CDN		
4-2	LY7765001	1	USB COVER PRINTED ASSY	HL-L8350CDW		
4-2	LY7765001	1	USB COVER PRINTED ASSY	HL-L8350CDWT		
4-3	LY7766001	1	PANEL COVER ASSY	HL-L8250CDN		
4-3	LY7912001	1	PANEL COVER ASSY	HL-L8350CDW		
4-3	LY7912001	1	PANEL COVER ASSY	HL-L8350CDWT		
4-3-1	LY1908001	1	RUBBER KEY PRINTED ASSY	HL-L8250CDN		
4-3-1	LY1908001	1	RUBBER KEY PRINTED ASSY	HL-L8350CDW		
4-3-1	LY1908001	1	RUBBER KEY PRINTED ASSY	HL-L8350CDWT		
4-3-2	LV1148001	1	PANEL PCB ASSY	HL-L8250CDN		
4-3-2	LV1148001	1	PANEL PCB ASSY	HL-L8350CDW		
4-3-2	LV1148001	1	PANEL PCB ASSY	HL-L8350CDWT		
4-3-3	A62009001	1	LCD	HL-L8250CDN		
4-3-3	A62009001	1	LCD	HL-L8350CDW		
4-3-3	A62009001	1	LCD	HL-L8350CDWT		
4-4	LV1391001	1	USB HOST RELAY PCB ASSY	HL-L8250CDN		
4-4	LV1391001	1	USB HOST RELAY PCB ASSY	HL-L8350CDW		
4-4	LV1391001	1	USB HOST RELAY PCB ASSY	HL-L8350CDWT		
4-5	LT2155001	1	WIRELESS LAN PCB	HL-L8350CDW		
4-5	LT2155001	1	WIRELESS LAN PCB	HL-L8350CDWT		
4	LU4927001	1	TOP COVER ASSY (SP)	HL-L9200CDW		
5	LU4927001	1	TOP COVER ASSY (SP)	HL-L9200CDWT		
5	LR2209001	1	TOP COVER ASSY (SP)	HL-L9300CDW		
5	LR2209001	1	TOP COVER ASSY (SP)	HL-L9300CDWT		
5-1	LY0428003	1	SUPPORT FLAP	HL-L9200CDW		
5-1	LY0428003	1	SUPPORT FLAP	HL-L9200CDWT		
5-1	LY0428003	1	SUPPORT FLAP	HL-L9300CDW		
5-1	LY0428003	1	SUPPORT FLAP	HL-L9300CDWT		
5-2	LV1149001	1	PANEL CONTROL PCB ASSY	HL-L9200CDW		
5-2	LV1149001	1	PANEL CONTROL PCB ASSY	HL-L9200CDWT		
5-2	LV1149001	1	PANEL CONTROL PCB ASSY	HL-L9300CDW		
5-2	LV1149001	1	PANEL CONTROL PCB ASSY	HL-L9300CDWT		
5-3	LY7862001	1	PANEL CASE ASSY	HL-L9200CDW		
5-3	LY7862001	1	PANEL CASE ASSY	HL-L9200CDWT		
5-3	LY7862001	1	PANEL CASE ASSY	HL-L9300CDW		
5-3	LY7862001	1	PANEL CASE ASSY	HL-L9300CDWT		
5-3-1	LV1169001	1	KEY PCB FLAT CABLE	HL-L9200CDW		
5-3-1	LV1169001	1	KEY PCB FLAT CABLE	HL-L9200CDWT		
5-3-1	LV1169001	1	KEY PCB FLAT CABLE	HL-L9300CDW		
5-3-1	LV1169001	1	KEY PCB FLAT CABLE	HL-L9300CDWT		
5-4	LY7793001	1	LCD PANEL ASSY	HL-L9200CDW		
5-4	LY7793001	1	LCD PANEL ASSY	HL-L9200CDWT		
5-4	LR2013001	1	LCD PANEL ASSY	HL-L9300CDW		
5-4	LR2013001	1	LCD PANEL ASSY	HL-L9300CDWT		
5-5	LY7765002	1	USB COVER PRINTED ASSY	HL-L9200CDW		
5-5	LY7765002	1	USB COVER PRINTED ASSY	HL-L9200CDWT		
5-5	LY7765002	1	USB COVER PRINTED ASSY	HL-L9300CDW		
5-5	LY7765002	1	USB COVER PRINTED ASSY	HL-L9300CDWT		
5-6	LV1391001	1	USB HOST RELAY PCB ASSY	HL-L9200CDW		
5-6	LV1391001	1	USB HOST RELAY PCB ASSY	HL-L9200CDWT		
5-6	LV1391001	1	USB HOST RELAY PCB ASSY	HL-L9300CDW		
5-6	LV1391001	1	USB HOST RELAY PCB ASSY	HL-L9300CDWT		
5-7	LT2155001	1	WIRELESS LAN PCB	HL-L9200CDW		
5-7	LT2155001	1	WIRELESS LAN PCB	HL-L9200CDWT		
5-7	LT2155001	1	WIRELESS LAN PCB	HL-L9300CDW		
5-7	LT2155001	1	WIRELESS LAN PCB	HL-L9300CDWT		
6	LY1866001	1	SIDE COVER R			

10. COVERS & LABELS

REF No.	CODE	QTY	DESCRIPTION	MODEL	SPEC	REMARKS
7	LY7768001	1	SIDE COVER L ASSY			
8	LY1868001	1	REAR COVER			
9	LY0450001	1	REAR COVER STOPPER ARM L			
10	LY0451001	1	REAR COVER STOPPER ARM R			
11	LY0452003	1	MP COVER ASSY	HL-L8250CDN		
11	LY0452003	1	MP COVER ASSY	HL-L8350CDW		
11	LY0452003	1	MP COVER ASSY	HL-L8350CDWT		
11	LY0452004	1	MP COVER ASSY	HL-L9200CDW		
11	LY0452004	1	MP COVER ASSY	HL-L9200CDWT		
11	LY0452004	1	MP COVER ASSY	HL-L9300CDW		
11	LY0452004	1	MP COVER ASSY	HL-L9300CDWT		
12	LY0456003	1	MP PAPER GUIDE ASSY	HL-L8250CDN		
12	LY0456003	1	MP PAPER GUIDE ASSY	HL-L8350CDW		
12	LY0456003	1	MP PAPER GUIDE ASSY	HL-L8350CDWT		
12	LY0456004	1	MP PAPER GUIDE ASSY	HL-L9200CDW		
12	LY0456004	1	MP PAPER GUIDE ASSY	HL-L9200CDWT		
12	LY0456004	1	MP PAPER GUIDE ASSY	HL-L9300CDW		
12	LY0456004	1	MP PAPER GUIDE ASSY	HL-L9300CDWT		
13	LY1929003	1	MP LINK R	HL-L8250CDN		
13	LY1929003	1	MP LINK R	HL-L8350CDW		
13	LY1929003	1	MP LINK R	HL-L8350CDWT		
13	LY1929004	1	MP LINK R	HL-L9200CDW		
13	LY1929004	1	MP LINK R	HL-L9200CDWT		
13	LY1929004	1	MP LINK R	HL-L9300CDW		
13	LY1929004	1	MP LINK R	HL-L9300CDWT		
14	LY0460003	1	MP LINK L	HL-L8250CDN		
14	LY0460003	1	MP LINK L	HL-L8350CDW		
14	LY0460003	1	MP LINK L	HL-L8350CDWT		
14	LY0460004	1	MP LINK L	HL-L9200CDW		
14	LY0460004	1	MP LINK L	HL-L9200CDWT		
14	LY0460004	1	MP LINK L	HL-L9300CDW		
14	LY0460004	1	MP LINK L	HL-L9300CDWT		
15	LY0872001	1	LAN PORT CAP			
16	LY4852002	1	EMBLEM BROTHER SHEET	HL-L8250CDN		
16	LY4852002	1	EMBLEM BROTHER SHEET	HL-L8350CDW		
16	LY4852002	1	EMBLEM BROTHER SHEET	HL-L8350CDWT		
16	LY4852005	1	EMBLEM BROTHER SHEET	HL-L9200CDW		
16	LY4852005	1	EMBLEM BROTHER SHEET	HL-L9200CDWT		
16	LY4852005	1	EMBLEM BROTHER SHEET	HL-L9300CDW		
16	LY4852005	1	EMBLEM BROTHER SHEET	HL-L9300CDWT		
17	LY7850001	1	COLOR LASER LABEL	HL-L8250CDN		
17	LY7850001	1	COLOR LASER LABEL	HL-L8350CDW		
17	LY7850001	1	COLOR LASER LABEL	HL-L8350CDWT		
17	LY7850002	1	COLOR LASER LABEL	HL-L9200CDW		
17	LY7850002	1	COLOR LASER LABEL	HL-L9200CDWT		
17	LY7850002	1	COLOR LASER LABEL	HL-L9300CDW		
17	LY7850002	1	COLOR LASER LABEL	HL-L9300CDWT		
18	LY7886001	1	MP SET INSTRUCTION LABEL			
19	LY7888001	1	LABEL H/SP CAUTION REAR 49X45			
20	LY7889001	1	LABEL DR OPERATION PRN			
21	LY1430001	1	LABEL HIGH TEMP 13.9X13.4			
22	LY7894001	1	BELT OPERATION LABEL			
23	LY1160001	1	LABEL FRONT JAM 18X16			
24	LY7987001	1	LABEL H/SP CAUTION F	HL-L8250CDN	FOR CHN	
24	LY7987001	1	LABEL H/SP CAUTION F	HL-L8250CDN	FOR US/US FS	
24	LY7984001	1	LABEL H/SP CAUTION F	HL-L8250CDN	FOR ARL	
24	LY7986001	1	LABEL H/SP CAUTION F	HL-L8250CDN	FOR SGP/KOR	
24	LY7892001	1	LABEL H/SP CAUTION F	HL-L8250CDN	FOR GER/UK/CHE/ITA/IBR/RUS/ FRA/BEL/NLD/PND/CEE	
24	LY7891001	1	LABEL H/SP CAUTION F	HL-L8350CDW	FOR US/CAN/US FS	
24	LY7984001	1	LABEL H/SP CAUTION F	HL-L8350CDW	FOR ARL	
24	LY7982001	1	LABEL H/SP CAUTION F	HL-L8350CDW	FOR ARG/CHL/BRZ	
24	LU6853001	1	LABEL H/SP CAUTION F	HL-L8350CDW	FOR GUL	
24	LY7986001	1	LABEL H/SP CAUTION F	HL-L8350CDW	FOR TWN/SGP/KOR	
24	LY7893001	1	LABEL H/SP CAUTION F	HL-L8350CDW	FOR GER/UK/CHE/ITA/IBR/FRA/ BEL/NLD/PND/CEE	
24	LY7891001	1	LABEL H/SP CAUTION F	HL-L8350CDWT		
24	LY7987001	1	LABEL H/SP CAUTION F	HL-L9200CDW	FOR CHN	
24	LY7981001	1	LABEL H/SP CAUTION F	HL-L9200CDW	FOR US/CAN	
24	LY7985001	1	LABEL H/SP CAUTION F	HL-L9200CDW	FOR ARL	
24	LY7981001	1	LABEL H/SP CAUTION F	HL-L9200CDWT	FOR US	
24	LY7983001	1	LABEL H/SP CAUTION F	HL-L9200CDWT	FOR GER/UK/CHE/ITA/IBR/RUS/ FRA/BEL/NLD/PND/CEE	

10. COVERS & LABELS

REF No.	CODE	QTY	DESCRIPTION	MODEL	SPEC	REMARKS
24	LY7981001	1	LABEL H/SP CAUTION F	HL-L9300CDW		
24	LY7981001	1	LABEL H/SP CAUTION F	HL-L9300CDWT	FOR US	
24	LY7983001	1	LABEL H/SP CAUTION F	HL-L9300CDWT	FOR GER/UK/CHE/ITA/IBR/FRA/ BEL/NLD/PND	

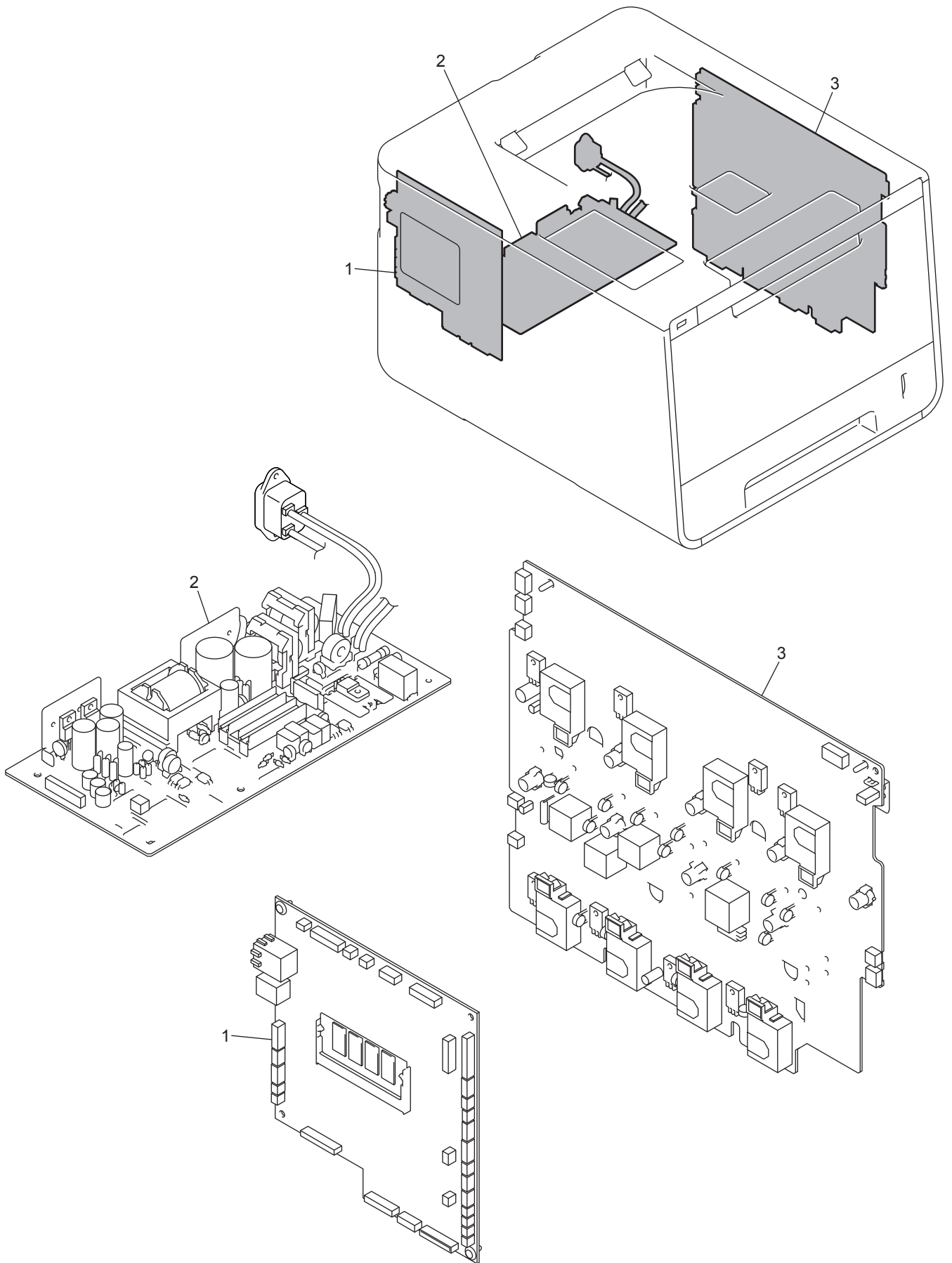

11. PCB

REF No.	CODE	Q'TY	DESCRIPTION	MODEL	SPEC	REMARKS
1	LV1254001	1	MAIN PCB ASSY	HL-L8250CDN	FOR US/GER/UK/ARL/CHE/ITA/ IBR/CHN/SGP/KOR/RUS/FRA/ BEL/NLD/PND/CEE	
1	LV1254002	1	MAIN PCB ASSY (*)	HL-L8250CDN	FOR US_FS	
1	LV1253001	1	MAIN PCB ASSY	HL-L8350CDW	FOR US/CAN/GER/UK/ARL/CHE/ ITA/IBR/TWN/ARG/CHL/GUL/BRZ/ SGP/KOR/FRA/BEL/NLD/PND/CEE	
1	LV1253002	1	MAIN PCB ASSY (*)	HL-L8350CDW	FOR US_FS	
1	LV1253001	1	MAIN PCB ASSY	HL-L8350CDWT		
1	LV1147001	1	MAIN PCB B512380 ASSY1 BC2P	HL-L9200CDW		
1	LV1147001	1	MAIN PCB B512380 ASSY1 BC2P	HL-L9200CDWT		
1	LV1451001	1	MAIN PCB ASSY	HL-L9300CDW		
1	LV1451001	1	MAIN PCB ASSY	HL-L9300CDWT		
2	LV1216001	1	LOW-VOLTAGE POWER SUPPLY PCB UNIT	HL-L8250CDN	FOR US/US_FS	
2	LV1108001	1	LOW-VOLTAGE POWER SUPPLY PCB UNIT	HL-L8250CDN	FOR GER/UK/ARL/CHE/ITA/IBR/ SGP/KOR/FRA/BEL/NLD/PND/CEE	
2	LV1161001	1	LOW-VOLTAGE POWER SUPPLY PCB UNIT	HL-L8250CDN	FOR CHN/RUS	
2	LV1216001	1	LOW-VOLTAGE POWER SUPPLY PCB UNIT	HL-L8350CDW	FOR US/CAN/TWN/US_FS	
2	LV1108001	1	LOW-VOLTAGE POWER SUPPLY PCB UNIT	HL-L8350CDW	FOR GER/UK/ARL/CHE/ITA/IBR/ ARG/CHL/GUL/SGP/KOR/FRA/ BEL/NLD/PND/CEE	
2	LV1306001	1	LOW-VOLTAGE POWER SUPPLY PCB UNIT	HL-L8350CDW	FOR BRZ	
2	LV1216001	1	LOW-VOLTAGE POWER SUPPLY PCB UNIT	HL-L8350CDWT		
2	LV1216001	1	LOW-VOLTAGE POWER SUPPLY PCB UNIT	HL-L9200CDW	FOR US/CAN	
2	LV1108001	1	LOW-VOLTAGE POWER SUPPLY PCB UNIT	HL-L9200CDW	FOR ARL	
2	LV1161001	1	LOW-VOLTAGE POWER SUPPLY PCB UNIT	HL-L9200CDW	FOR CHN	
2	LV1216001	1	LOW-VOLTAGE POWER SUPPLY PCB UNIT	HL-L9200CDWT	FOR US	
2	LV1108001	1	LOW-VOLTAGE POWER SUPPLY PCB UNIT	HL-L9200CDWT	FOR GER/UK/CHE/ITA/IBR/FRA/ BEL/NLD/PND/CEE	
2	LV1161001	1	LOW-VOLTAGE POWER SUPPLY PCB UNIT	HL-L9200CDWT	FOR RUS	
2	LT2763001	1	LOW-VOLTAGE POWER SUPPLY PCB UNIT	HL-L9300CDW		
2	LT2763001	1	LOW-VOLTAGE POWER SUPPLY PCB UNIT	HL-L9300CDWT	FOR US	
2	LT2764001	1	LOW-VOLTAGE POWER SUPPLY PCB UNIT	HL-L9300CDWT	FOR GER/UK/CHE/ITA/IBR/FRA/ BEL/NLD/PND	
3	LY7790001	1	HIGH-VOLTAGE POWER SUPPLY PCB ASSY			

(*) First 3-months production only

12.ACCESSORIES

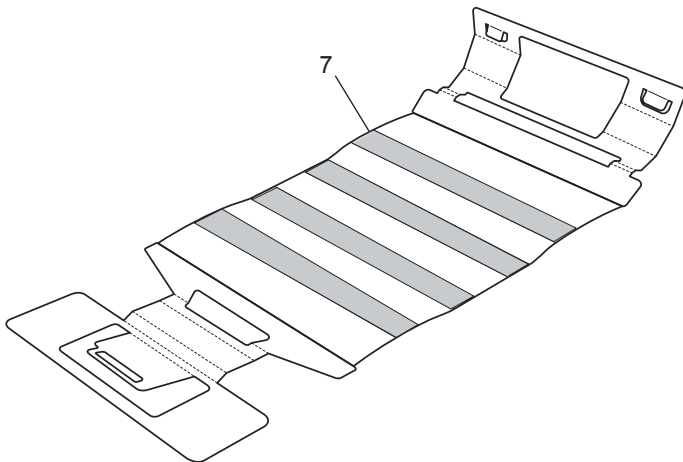
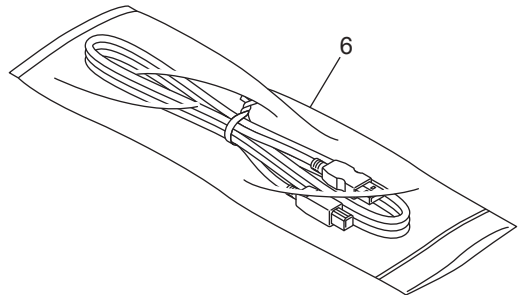
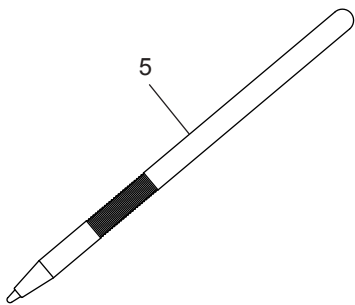
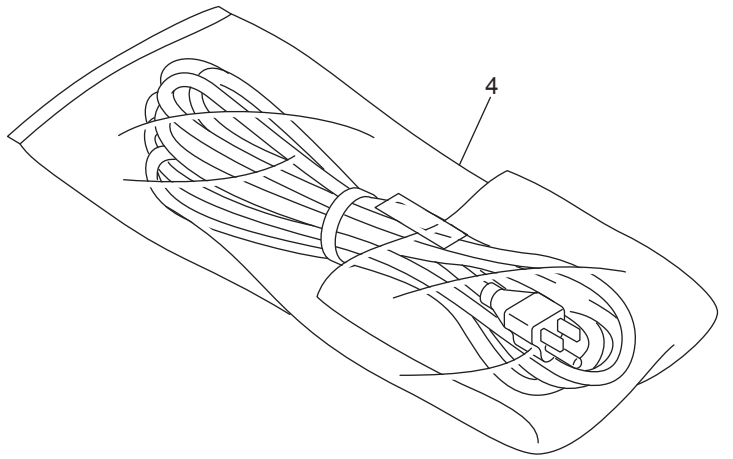
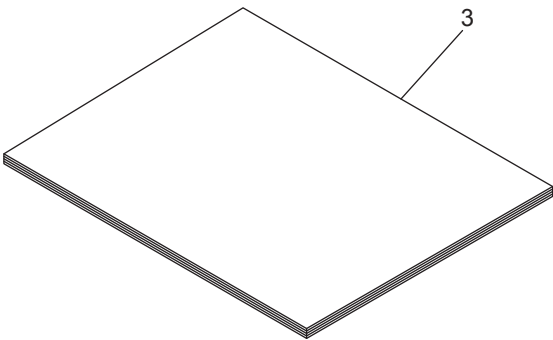
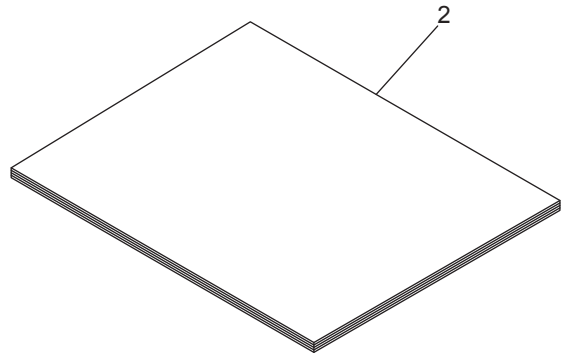
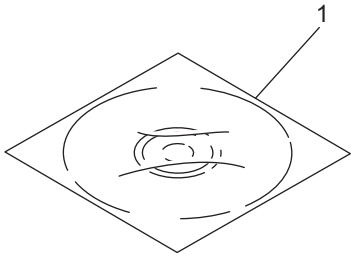

12. ACCESSORIES

REF No.	CODE	Q'TY	DESCRIPTION	MODEL	SPEC	REMARKS
1	LR2073001	1	CDROM ASSY	HL-L9300CDW		
1	LR2073001	1	CDROM ASSY	HL-L9300CDWT	FOR US	
1	LY7905001	1	CDROM ASSY	HL-L8250CDN	FOR US/US_FS	
1	LY7905001	1	CDROM ASSY	HL-L8350CDW	FOR US/US_FS	
1	LY7905001	1	CDROM ASSY	HL-L8350CDWT		
1	LY7905001	1	CDROM ASSY	HL-L9200CDW	FOR US	
1	LY7905001	1	CDROM ASSY	HL-L9200CDWT	FOR US	
1	LY7910001	1	CDROM ASSY	HL-L8350CDW	FOR CAN	
1	LU4899001	1	CDROM ASSY	HL-L9200CDW	FOR CAN	
1	LY7903001	1	CDROM ASSY	HL-L8250CDN	FOR GER/UK/CHE/ITA/IBR/ FRA/BEL/NLD/PND	
1	LY7903001	1	CDROM ASSY	HL-L8350CDW	FOR GER/UK/CHE/ITA/IBR/ FRA/BEL/NLD/PND	
1	LU4521001	1	CDROM ASSY	HL-L9200CDWT	FOR GER/UK/CHE/ITA/IBR/ FRA/BEL/NLD/PND	
1	LR2074001	1	CDROM ASSY	HL-L9300CDWT	FOR GER/UK/CHE/ITA/IBR/ FRA/BEL/NLD/PND	
1	LY7911001	1	CDROM ASSY	HL-L8250CDN	FOR ARL/SGP	
1	LY7911001	1	CDROM ASSY	HL-L8350CDW	FOR ARL/ARG/CHL/GUL/BRZ/SGP	
1	LU4900001	1	CDROM ASSY	HL-L9200CDW	FOR ARL	
1	LY7908001	1	CDROM ASSY	HL-L8250CDN	FOR CHN	
1	LY7908001	1	CDROM ASSY	HL-L9200CDW	FOR CHN	
1	LR2065001	1	CDROM ASSY	HL-L8350CDW	FOR TWN	
1	LY7909001	1	CDROM ASSY	HL-L8250CDN	FOR KOR	
1	LY7909001	1	CDROM ASSY	HL-L8350CDW	FOR KOR	
1	LY7906001	1	CDROM ASSY	HL-L8250CDN	FOR RUS/CEE	
1	LY7906001	1	CDROM ASSY	HL-L8350CDW	FOR CEE	
1	LU4901001	1	CDROM ASSY	HL-L9200CDWT	FOR RUS/CEE	
2	LU4808001	1	SETUP GUIDE (GERMAN)	HL-L8250CDN	FOR GER/CHE	
2	LU4808001	1	SETUP GUIDE (GERMAN)	HL-L8350CDW	FOR GER/CHE	
2	LR2111001	1	SETUP GUIDE (GERMAN)	HL-L9200CDWT	FOR GER/CHE	CHG
2	LR2111001	1	SETUP GUIDE (GERMAN)	HL-L9300CDWT	FOR GER/CHE	
2	LU4807001	1	SETUP GUIDE (PORTUGUESE)	HL-L8350CDW	FOR BRZ	
2	LU4832001	1	SETUP GUIDE (KOREAN)	HL-L8250CDN	FOR KOR	
2	LU4832001	1	SETUP GUIDE (KOREAN)	HL-L8350CDW	FOR KOR	
2	LR2092001	1	SETUP GUIDE (TAIWANESE)	HL-L8350CDW	FOR TWN	
2	LR2110001	1	SETUP GUIDE (ENGLISH)	HL-L9300CDW		
2	LR2110001	1	SETUP GUIDE (ENGLISH)	HL-L9300CDWT	FOR US/UK	
2	LU4805001	1	SETUP GUIDE (ENGLISH)	HL-L8250CDN	FOR US/UK/ARL/SGP/US_FS/CEE	
2	LU4805001	1	SETUP GUIDE (ENGLISH)	HL-L8350CDW	FOR US/CAN/UK/ARL/GUL/SGP/ US_FS/CEE	
2	LU4805001	1	SETUP GUIDE (ENGLISH)	HL-L8350CDWT		
2	LR2110001	1	SETUP GUIDE (ENGLISH)	HL-L9200CDW	FOR US/CAN/ARL	CHG
2	LR2110001	1	SETUP GUIDE (ENGLISH)	HL-L9200CDWT	FOR US/UK/CEE	CHG
2	LU4833001	1	SETUP GUIDE (CHINESE)	HL-L8250CDN	FOR CHN	
2	LU4856001	1	SETUP GUIDE (CHINESE)	HL-L9200CDW	FOR CHN	
2	LU4829001	1	SETUP GUIDE (INDONESIAN)	HL-L8250CDN	FOR SGP	
2	LU4829001	1	SETUP GUIDE (INDONESIAN)	HL-L8350CDW	FOR SGP	
2	LU4818001	1	SETUP GUIDE (RUSSIAN)	HL-L8250CDN	FOR RUS	
2	LU4847001	1	SETUP GUIDE (RUSSIAN)	HL-L9200CDWT	FOR RUS	
2	LU4814001	1	SETUP GUIDE (FINNISH)	HL-L8250CDN	FOR PND	
2	LU4814001	1	SETUP GUIDE (FINNISH)	HL-L8350CDW	FOR PND	
2	LR2117001	1	SETUP GUIDE (FINNISH)	HL-L9200CDWT	FOR PND	CHG
2	LR2117001	1	SETUP GUIDE (FINNISH)	HL-L9300CDWT	FOR PND	
2	LU4821001	1	SETUP GUIDE (CZECH)	HL-L8250CDN	FOR CEE	
2	LU4821001	1	SETUP GUIDE (CZECH)	HL-L8350CDW	FOR CEE	
2	LU4850001	1	SETUP GUIDE (CZECH)	HL-L9200CDWT	FOR CEE	
2	LU4809001	1	SETUP GUIDE (FRENCH)	HL-L8250CDN	FOR CHE/FRA/BEL/NLD	
2	LU4809001	1	SETUP GUIDE (FRENCH)	HL-L8350CDW	FOR CHE/FRA/BEL/NLD	
2	LR2112001	1	SETUP GUIDE (FRENCH)	HL-L9200CDWT	FOR CHE/FRA/BEL/NLD	CHG
2	LR2112001	1	SETUP GUIDE (FRENCH)	HL-L9300CDWT	FOR CHE/FRA/BEL/NLD	
2	LU4827001	1	SETUP GUIDE (TURKISH)	HL-L8350CDW	FOR GUL	
2	LU4830001	1	SETUP GUIDE (VIETNAMESE)	HL-L8250CDN	FOR SGP	
2	LU4830001	1	SETUP GUIDE (VIETNAMESE)	HL-L8350CDW	FOR SGP	
2	LU4819001	1	SETUP GUIDE (BELARUSIAN)	HL-L8250CDN	FOR RUS	
2	LU4848001	1	SETUP GUIDE (BELARUSIAN)	HL-L9200CDWT	FOR RUS	
2	LU4813001	1	SETUP GUIDE (DUTCH)	HL-L8250CDN	FOR FRA/BEL/NLD	
2	LU4813001	1	SETUP GUIDE (DUTCH)	HL-L8350CDW	FOR FRA/BEL/NLD	
2	LR2116001	1	SETUP GUIDE (DUTCH)	HL-L9200CDWT	FOR FRA/BEL/NLD	CHG
2	LR2116001	1	SETUP GUIDE (DUTCH)	HL-L9300CDWT	FOR FRA/BEL/NLD	
2	LU4815001	1	SETUP GUIDE (DANISH)	HL-L8250CDN	FOR PND	
2	LU4815001	1	SETUP GUIDE (DANISH)	HL-L8350CDW	FOR PND	

12. ACCESSORIES

REF No.	CODE	Q'TY	DESCRIPTION	MODEL	SPEC	REMARKS
2	LR2118001	1	SETUP GUIDE (DANISH)	HL-L9200CDWT	FOR PND	CHG
2	LR2118001	1	SETUP GUIDE (DANISH)	HL-L9300CDWT	FOR PND	
2	LU4822001	1	SETUP GUIDE (HUNGARIAN)	HL-L8250CDN	FOR CEE	
2	LU4822001	1	SETUP GUIDE (HUNGARIAN)	HL-L8350CDW	FOR CEE	
2	LU4851001	1	SETUP GUIDE (HUNGARIAN)	HL-L9200CDWT	FOR CEE	
2	LU4806001	1	SETUP GUIDE (FRENCH)	HL-L8350CDW	FOR CAN	
2	LU4836001	1	SETUP GUIDE (FRENCH)	HL-L9200CDW	FOR CAN	
2	LU4810001	1	SETUP GUIDE (ITALIAN)	HL-L8250CDN	FOR CHE/ITA/IBR	
2	LU4810001	1	SETUP GUIDE (ITALIAN)	HL-L8350CDW	FOR CHE/ITA/IBR	
2	LR2113001	1	SETUP GUIDE (ITALIAN)	HL-L9200CDWT	FOR CHE/ITA/IBR	CHG
2	LR2113001	1	SETUP GUIDE (ITALIAN)	HL-L9300CDWT	FOR CHE/ITA/IBR	
2	LU4828001	1	SETUP GUIDE (ARABIC)	HL-L8350CDW	FOR GUL	
2	LU4831001	1	SETUP GUIDE (THAI)	HL-L8250CDN	FOR SGP	
2	LU4831001	1	SETUP GUIDE (THAI)	HL-L8350CDW	FOR SGP	
2	LU4820001	1	SETUP GUIDE (KAZAKH)	HL-L8250CDN	FOR RUS	
2	LU4849001	1	SETUP GUIDE (KAZAKH)	HL-L9200CDWT	FOR RUS	
2	LU4816001	1	SETUP GUIDE (NORWEGIAN)	HL-L8250CDN	FOR PND	
2	LU4816001	1	SETUP GUIDE (NORWEGIAN)	HL-L8350CDW	FOR PND	
2	LR2119001	1	SETUP GUIDE (NORWEGIAN)	HL-L9200CDWT	FOR PND	CHG
2	LR2119001	1	SETUP GUIDE (NORWEGIAN)	HL-L9300CDWT	FOR PND	
2	LU4823001	1	SETUP GUIDE (POLISH)	HL-L8250CDN	FOR CEE	
2	LU4823001	1	SETUP GUIDE (POLISH)	HL-L8350CDW	FOR CEE	
2	LU4852001	1	SETUP GUIDE (POLISH)	HL-L9200CDWT	FOR CEE	
2	LU4811001	1	SETUP GUIDE (SPANISH)	HL-L8250CDN	FOR ITA/IBR	
2	LU4811001	1	SETUP GUIDE (SPANISH)	HL-L8350CDW	FOR ITA/IBR/ARG/CHL	
2	LR2114001	1	SETUP GUIDE (SPANISH)	HL-L9200CDWT	FOR ITA/IBR	CHG
2	LR2114001	1	SETUP GUIDE (SPANISH)	HL-L9300CDWT	FOR ITA/IBR	
2	LU4817001	1	SETUP GUIDE (SWEDISH)	HL-L8250CDN	FOR PND	
2	LU4817001	1	SETUP GUIDE (SWEDISH)	HL-L8350CDW	FOR PND	
2	LR2120001	1	SETUP GUIDE (SWEDISH)	HL-L9200CDWT	FOR PND	CHG
2	LR2120001	1	SETUP GUIDE (SWEDISH)	HL-L9300CDWT	FOR PND	
2	LU4824001	1	SETUP GUIDE (BULGARIAN)	HL-L8250CDN	FOR CEE	
2	LU4824001	1	SETUP GUIDE (BULGARIAN)	HL-L8350CDW	FOR CEE	
2	LU4853001	1	SETUP GUIDE (BULGARIAN)	HL-L9200CDWT	FOR CEE	
2	LU4812001	1	SETUP GUIDE (PORTUGUESE)	HL-L8250CDN	FOR ITA/IBR	
2	LU4812001	1	SETUP GUIDE (PORTUGUESE)	HL-L8350CDW	FOR ITA/IBR	
2	LR2115001	1	SETUP GUIDE (PORTUGUESE)	HL-L9200CDWT	FOR ITA/IBR	CHG
2	LR2115001	1	SETUP GUIDE (PORTUGUESE)	HL-L9300CDWT	FOR ITA/IBR	
2	LU4825001	1	SETUP GUIDE (ROMANIAN)	HL-L8250CDN	FOR CEE	
2	LU4825001	1	SETUP GUIDE (ROMANIAN)	HL-L8350CDW	FOR CEE	
2	LU4854001	1	SETUP GUIDE (ROMANIAN)	HL-L9200CDWT	FOR CEE	
2	LU4826001	1	SETUP GUIDE (SLOVAK)	HL-L8250CDN	FOR CEE	
2	LU4826001	1	SETUP GUIDE (SLOVAK)	HL-L8350CDW	FOR CEE	
2	LU4855001	1	SETUP GUIDE (SLOVAK)	HL-L9200CDWT	FOR CEE	
3	LU4976001	1	SETUP GUIDE LT	HL-L8350CDWT		chg
3	LU4976001	1	SETUP GUIDE LT	HL-L9200CDWT		chg
3	LU4976001	1	SETUP GUIDE LT	HL-L9300CDWT		
4	LM9362001	1	AC CORD BAG ASSY LF UL/CSA 13A	HL-L8250CDN	FOR US/US_FS	
4	LM9362001	1	AC CORD BAG ASSY LF UL/CSA 13A	HL-L8350CDW	FOR US/CAN/US_FS	
4	LM9362001	1	AC CORD BAG ASSY LF UL/CSA 13A	HL-L8350CDWT		
4	LM9362001	1	AC CORD BAG ASSY LF UL/CSA 13A	HL-L9200CDW	FOR US/CAN	
4	LM9362001	1	AC CORD BAG ASSY LF UL/CSA 13A	HL-L9200CDWT	FOR US	
4	LM9362001	1	AC CORD BAG ASSY LF UL/CSA 13A	HL-L9300CDW		
4	LM9362001	1	AC CORD BAG ASSY LF UL/CSA 13A	HL-L9300CDWT	FOR US	
4	LV0364001	1	AC CORD BAG ASSY LF VDE S	HL-L8250CDN	FOR GER/ITA/IBR/SGP/RUS/ FRA/BEL/NLD/PND/CEE	
4	LV0364001	1	AC CORD BAG ASSY LF VDE S	HL-L8350CDW	FOR GER/ITA/IBR/GUL/SGP/ FRA/BEL/NLD/PND/CEE	
4	LV0364001	1	AC CORD BAG ASSY LF VDE S	HL-L9200CDWT	FOR GER/ITA/IBR/RUS/FRA/ BEL/NLD/PND/CEE	
4	LV0364001	1	AC CORD BAG ASSY LF VDE S	HL-L9300CDWT	FOR GER/ITA/IBR/FRA/BEL/ NLD/PND	
4	LV0368001	1	AC CORD BAG ASSY LF BS/PSB S	HL-L8250CDN	FOR UK/SGP	
4	LV0368001	1	AC CORD BAG ASSY LF BS/PSB S	HL-L8350CDW	FOR UK/GUL/SGP	
4	LV0368001	1	AC CORD BAG ASSY LF BS/PSB S	HL-L9200CDWT	FOR UK	

12. ACCESSORIES

REF No.	CODE	Q'TY	DESCRIPTION	MODEL	SPEC	REMARKS
4	LV0368001	1	AC CORD BAG ASSY LF BS/PSB S	HL-L9300CDWT	FOR UK	
4	LV0366001	1	AC CORD BAG ASSY LF SAA S	HL-L8250CDN	FOR ARL	
4	LV0366001	1	AC CORD BAG ASSY LF SAA S	HL-L8350CDW	FOR ARL	
4	LV0366001	1	AC CORD BAG ASSY LF SAA S	HL-L9200CDW	FOR ARL	
4	LT2259001	1	AC CORD BAG ASSY LF SEV	HL-L8250CDN	FOR CHE	
4	LT2259001	1	AC CORD BAG ASSY LF SEV	HL-L8350CDW	FOR CHE	
4	LT2259001	1	AC CORD BAG ASSY LF SEV	HL-L9200CDWT	FOR CHE	
4	LT2259001	1	AC CORD BAG ASSY LF SEV	HL-L9300CDWT	FOR CHE	
4	LV1093001	1	AC CORD BAG ASSY LF CHN S/BRO	HL-L8250CDN	FOR CHN	
4	LV1093001	1	AC CORD BAG ASSY LF CHN S/BRO	HL-L9200CDW	FOR CHN	
4	LT1833001	1	AC CORD BAG ASSY LF TWN	HL-L8350CDW	FOR TWN	
4	LT0925001	1	AC CORD BAG ASSY LF IRAM	HL-L8350CDW	FOR ARG	
4	LG6207001	1	AC CORD BAG ASSY LF CHILE	HL-L8350CDW	FOR CHL	
4	LV1465001	1	AC CORD BAG ASSY LF INMETRO	HL-L8350CDW	FOR BRZ	chg
4	LT0935001	1	AC CORD BAG ASSY LF KOR S	HL-L8250CDN	FOR KOR	
4	LT0935001	1	AC CORD BAG ASSY LF KOR S	HL-L8350CDW	FOR KOR	
4	LV0388001	1	AC CORD BAG ASSY LF PERU	HL-L8350CDW	FOR CHL	add
4	LG4720001	1	AC CORD BAG ASSY LF DEMKO	HL-L8250CDN	FOR PND	
4	LG4720001	1	AC CORD BAG ASSY LF DEMKO	HL-L8350CDW	FOR PND	
4	LG4720001	1	AC CORD BAG ASSY LF DEMKO	HL-L9200CDWT	FOR PND	
4	LG4720001	1	AC CORD BAG ASSY LF DEMKO	HL-L9300CDWT	FOR PND	
4	LG6404001	1	AC CORD BAG ASSY LF SAF	HL-L8350CDW	FOR GUL	
5	LJ9803001	1	USB CABLE 2.0			
6	XA9940051	1	TOUCH PEN			
7	LU6915001	1	DRUM CLEANING SHEET KIT			add
(8)	LU4904001	1	FRENCH PANEL STICKER	HL-L8350CDW	FOR CAN	ADD
(8)	LU4905001	1	FRENCH PANEL STICKER	HL-L9200CDW	FOR CAN	ADD

13.PACKING MATERIALS

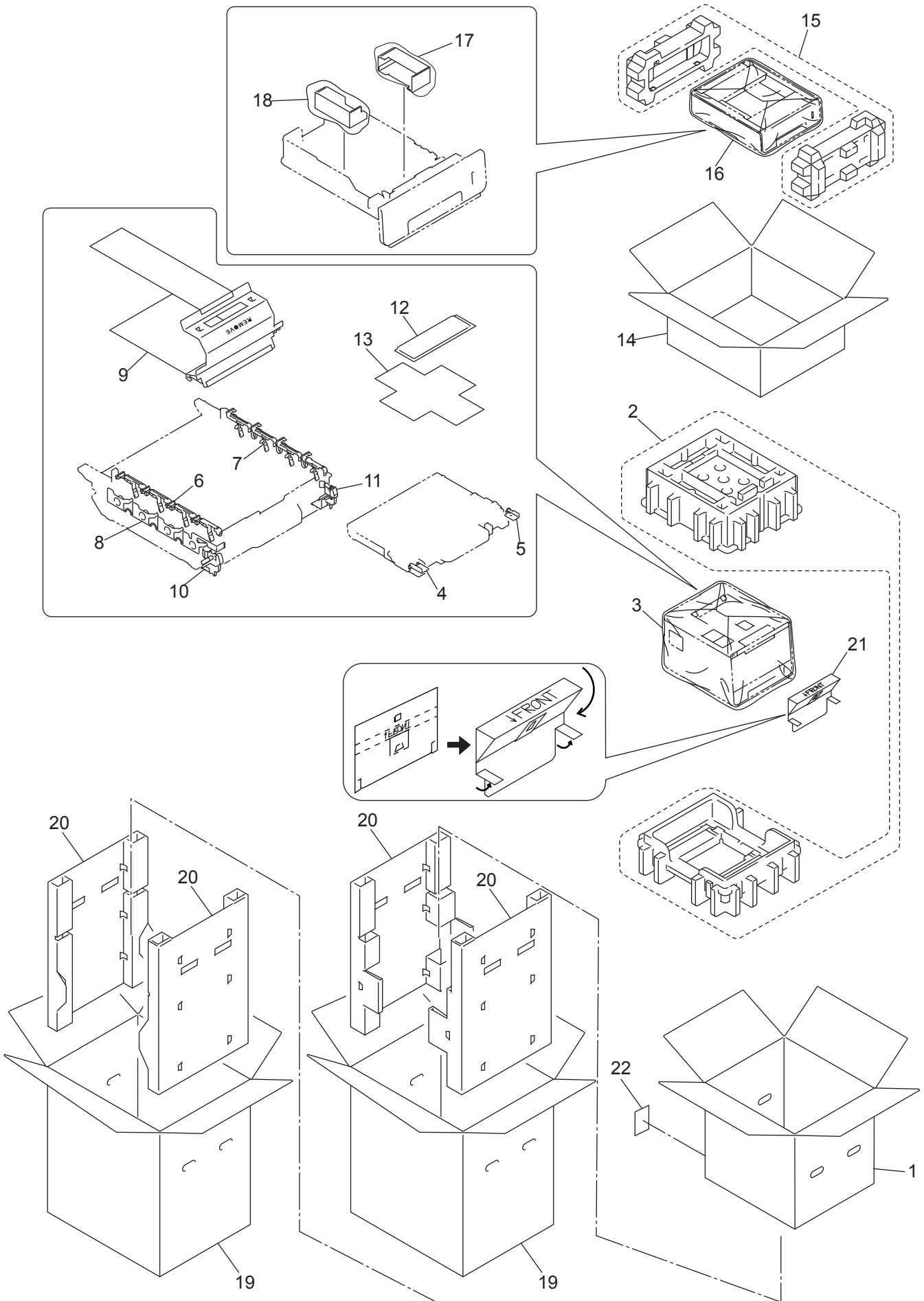

13. PACKING MATERIALS

REF No.	CODE	Q'TY	DESCRIPTION	MODEL	SPEC	REMARKS
1	LU4778001	1	CARTON	HL-L8250CDN	FOR US/US_FS	
1	LU4750001	1	CARTON	HL-L8250CDN	FOR GER/UK/CHE/ITA/IBR/RUS/ FRA/BEL/NLD/PND/CEE	
1	LU4756001	1	CARTON	HL-L8250CDN	FOR ARL	
1	LU4760001	1	CARTON	HL-L8250CDN	FOR CHN	
1	LU4754001	1	CARTON	HL-L8250CDN	FOR SGP/KOR	
1	LU4767001	1	CARTON	HL-L8350CDW	FOR US/US_FS	
1	LU4771001	1	CARTON	HL-L8350CDW	FOR CAN	
1	LU4751001	1	CARTON	HL-L8350CDW	FOR GER/UK/CHE/ITA/IBR/ FRA/BEL/NLD/PND/CEE	
1	LU4757001	1	CARTON	HL-L8350CDW	FOR ARL	
1	LU4755001	1	CARTON	HL-L8350CDW	FOR TWN/SGP/KOR	
1	LU4777001	1	CARTON	HL-L8350CDW	FOR ARG/CHL	
1	LU6881001	1	CARTON	HL-L8350CDW	FOR GUL	
1	LU4774001	1	CARTON	HL-L8350CDW	FOR BRZ	
1	LU4784001	1	CARTON	HL-L8350CDWT		
1	LU4782001	1	CARTON	HL-L9200CDW	FOR US/CAN	
1	LU4758001	1	CARTON	HL-L9200CDW	FOR ARL	
1	LU4761001	1	CARTON	HL-L9200CDW	FOR CHN	
1	LU4782001	1	CARTON	HL-L9200CDWT	FOR US	
1	LR2139001	1	CARTON	HL-L9300CDW		
1	LR2139001	1	CARTON	HL-L9300CDWT	FOR US	
2	LY7881001	1	POLYSTYRENE PAD ASSY	HL-L8250CDN	FOR US/GER/UK/ARL/CHE/ITA/ IBR/SGP/KOR/RUS/US_FS/ FRA/BEL/NLD/PND/CEE	
2	LY7877001	1	POLYSTYRENE PAD ASSY	HL-L8250CDN	FOR CHN	
2	LY7881001	1	POLYSTYRENE PAD ASSY	HL-L8350CDW		
2	LY7881001	1	POLYSTYRENE PAD ASSY	HL-L8350CDWT		
2	LY7877001	1	POLYSTYRENE PAD ASSY	HL-L9200CDW		
2	LY7877001	1	POLYSTYRENE PAD ASSY	HL-L9200CDWT		
2	LY7877001	1	POLYSTYRENE PAD ASSY	HL-L9300CDW		
2	LY7877001	1	POLYSTYRENE PAD ASSY	HL-L9300CDWT		
3	LY1721001	1	PE BAG 1000X1000			
4	LY0908001	1	CLEANER LOCK L			
5	LY0909001	1	CLEANER LOCK R			
6	LY0896001	1	DEVELOP SPACER L			
7	LY0897001	1	DEVELOP SPACER R			
8	LY0898001	1	DEVELOP STOPPER			
9	LY7999001	1	REMOVE SHEET ASSY			
10	LY0903001	1	DRM STOPPER L			
11	LU6891001	1	DRM STOPPER R			
12	LY1678001	1	SILICA GEL	HL-L8250CDN	FOR US/US_FS	chg
12	LY1679001	1	SILICA GEL	HL-L8250CDN	FOR GER/UK/ARL/CHE/ITA/IBR/ CHN/SGP/KOR/RUS/FRA/BEL/ NLD/PND/CEE	
12	LY1678001	1	SILICA GEL	HL-L8350CDW	FOR US/CAN/ARG/CHL/BRZ/US_FS	
12	LY1679001	1	SILICA GEL	HL-L8350CDW	FOR GER/UK/ARL/CHE/ITA/IBR/ TWN/GUL/SGP/KOR/FRA/BEL/ NLD/PND/CEE	
12	LY1678001	1	SILICA GEL	HL-L8350CDWT		
12	LY1678001	1	SILICA GEL	HL-L9200CDW	FOR US/CAN	
12	LY1679001	1	SILICA GEL	HL-L9200CDW	FOR ARL/CHN	
12	LY1678001	1	SILICA GEL	HL-L9200CDWT	FOR US	
12	LY1679001	1	SILICA GEL	HL-L9200CDWT	FOR GER/UK/CHE/ITA/IBR/RUS/ FRA/BEL/NLD/PND/CEE	
12	LY1678001	1	SILICA GEL	HL-L9300CDW		
12	LY1678001	1	SILICA GEL	HL-L9300CDWT	FOR US	
12	LY1679001	1	SILICA GEL	HL-L9300CDWT	FOR GER/UK/CHE/ITA/IBR/ FRA/BEL/NLD/PND	
13	LY1395001	1	SILICA GEL SHEET			
14	LU4589001	1	CARTON LT	HL-L8350CDWT		
14	LU4590001	1	CARTON LT	HL-L9200CDWT		
15	LY0690001	1	STYROFOAM PAD ASSY LT	HL-L8350CDWT		
15	LY0690001	1	STYROFOAM PAD ASSY LT	HL-L9200CDWT		
15	LU6979001	1	STYROFOAM PAD ASSY LT	HL-L9300CDWT		
16	LJ5584001	1	BAG 700X800H	HL-L8350CDWT		
16	LJ5584001	1	BAG 700X800H	HL-L9200CDWT		
16	LJ5584001	1	BAG 700X800H	HL-L9300CDWT		
17	LU6727001	1	P-TRAY HOLD PAD L ASSY	HL-L8350CDWT		
17	LU6727001	1	P-TRAY HOLD PAD L ASSY	HL-L9200CDWT		
17	LU6727001	1	P-TRAY HOLD PAD L ASSY	HL-L9300CDWT		
18	LY5864001	1	P-TRAY HOLD PAD S ASSY	HL-L8350CDWT		

13. PACKING MATERIALS

REF No.	CODE	Q'TY	DESCRIPTION	MODEL	SPEC	REMARKS
18	LY5864001	1	P-TRAY HOLD PAD S ASSY	HL-L9200CDWT		
18	LY5864001	1	P-TRAY HOLD PAD S ASSY	HL-L9300CDWT		
19	LU4783001	1	CARTON OUTER	HL-L8350CDWT		
19	LU4785001	1	CARTON OUTER	HL-L9200CDWT	FOR US	
19	LU4752001	1	CARTON OUTER	HL-L9200CDWT	FOR GER/UK/CHE/ITA/IBR/RUS/ FRA/BEL/NLD/PND/CEE	
19	LR2145001	1	CARTON OUTER	HL-L9300CDWT	FOR US	
19	LR2147001	1	CARTON OUTER	HL-L9300CDWT	FOR GER/UK/CHE/ITA/IBR/ FRA/BEL/NLD/PND	
20	LU4707001	2	CARTON SPACER	HL-L8350CDWT		
20	LY7915001	2	CARTON SPACER	HL-L9200CDWT		
20	LY7915001	2	CARTON SPACER	HL-L9300CDWT		
21	LU6883001	1	CARTON SPACER A	HL-L8250CDN	FOR CHN	
21	LU6883001	1	CARTON SPACER A	HL-L9200CDW		add
21	LU6883001	1	CARTON SPACER A	HL-L9200CDWT		add
21	LU6883001	1	CARTON SPACER A	HL-L9300CDW		
21	LU6883001	1	CARTON SPACER A	HL-L9300CDWT		
22	LR2174001	1	CHINA ENERGY LABEL	HL-L8250CDN	FOR CHN	CHG
22	LR2175001	1	CHINA ENERGY LABEL	HL-L9200CDW	FOR CHN	CHG

14.PERIODICAL MAINTENANCE PARTS

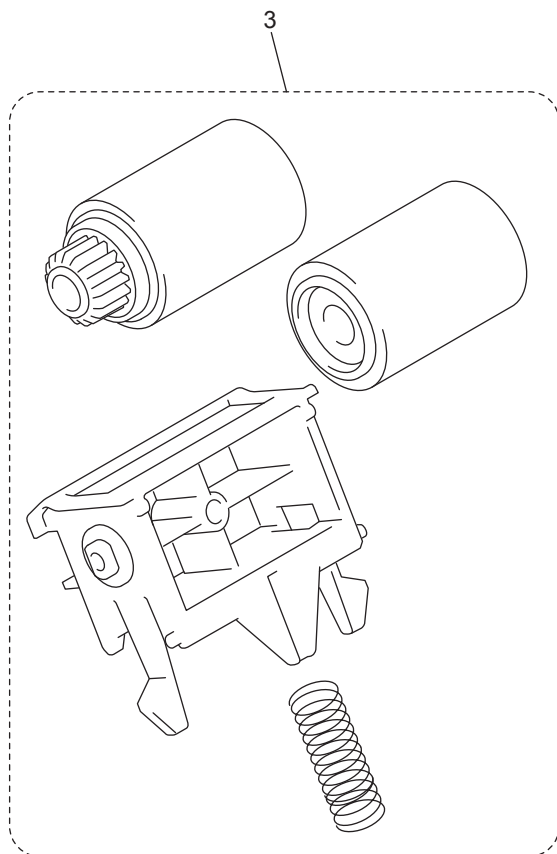
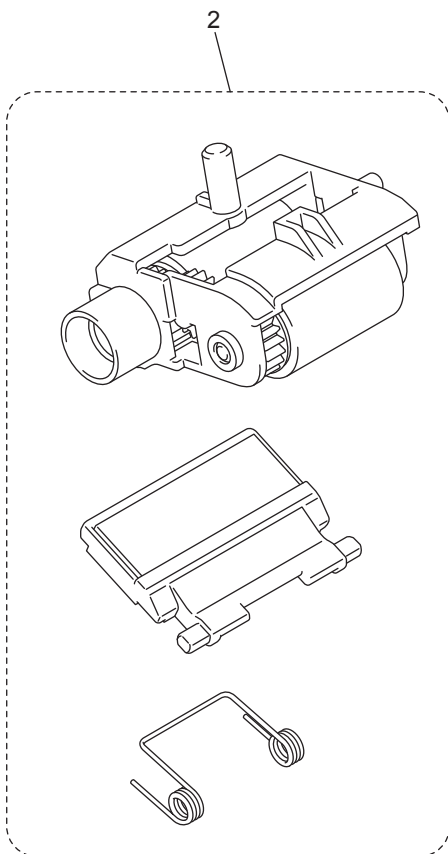
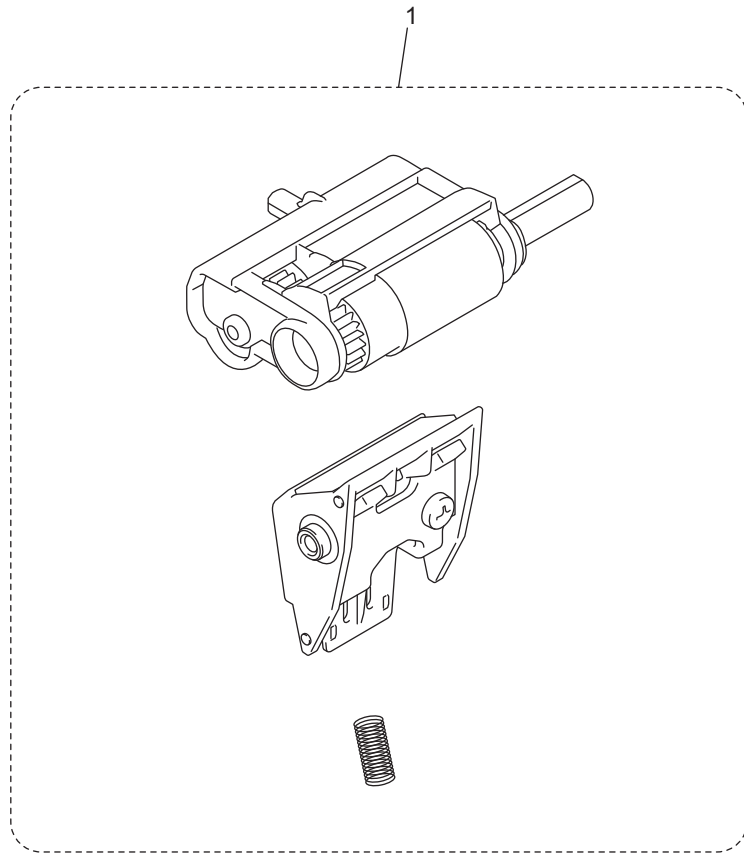

14.PERIODICAL MAINTENANCE PARTS

REF No.	CODE	Q'TY	DESCRIPTION	MODEL	SPEC	REMARKS
1	LU4978001	1	PAPER FEEDING KIT 1			
2	LU4979001	1	MP PAPER FEEDING KIT			
3	LY1548001	1	PAPER FEEDING KIT 2 (SP)	HL-L8350CDWT		
3	LY1548001	1	PAPER FEEDING KIT 2 (SP)	HL-L9200CDWT		
3	LR2210001	1	PAPER FEEDING KIT 2 (SP)	HL-L9300CDWT		
3	LR2210001	1	PAPER FEEDING KIT 3 (SP)	HL-L9300CDWT		

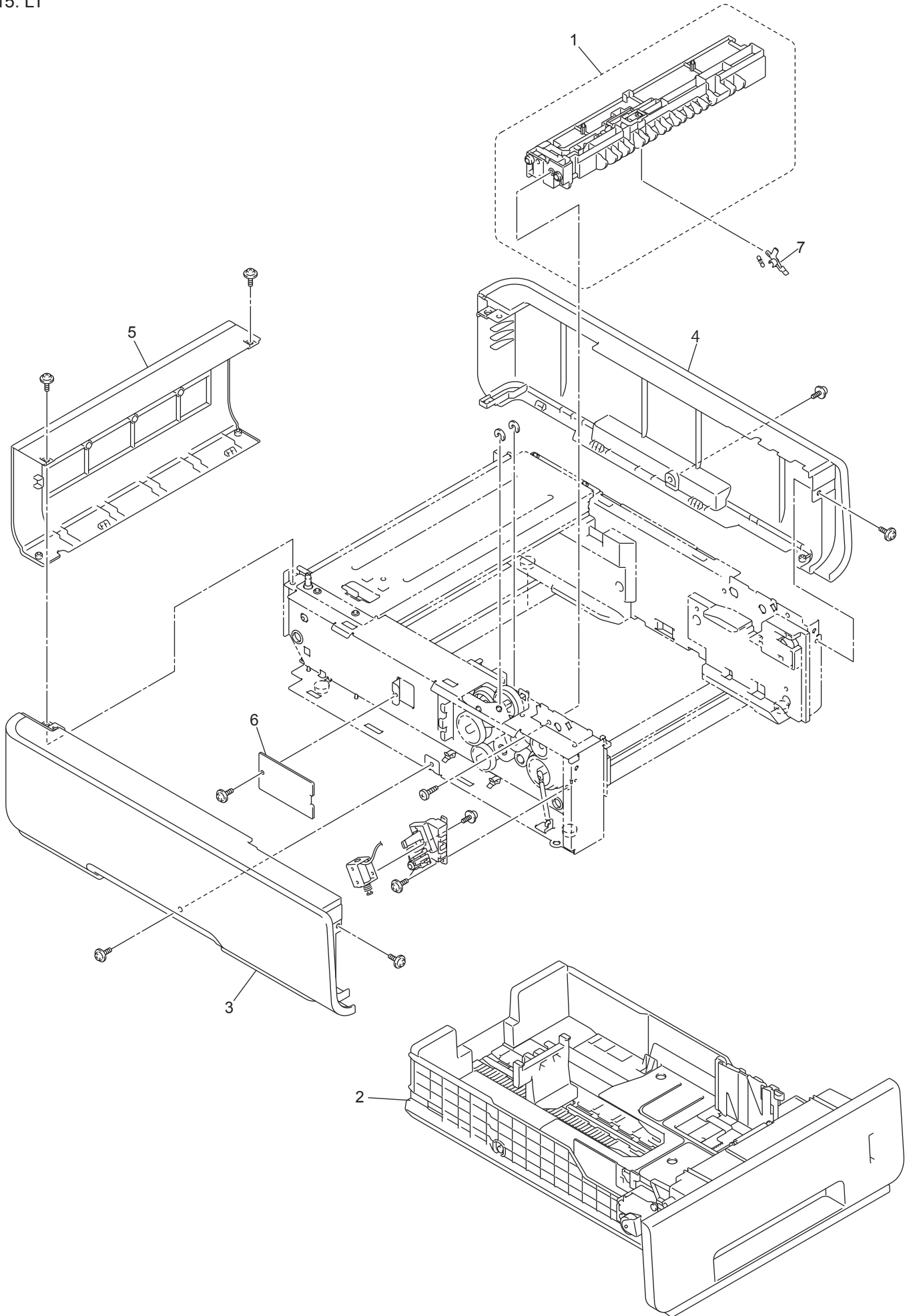

15. LT

REF No.	CODE	QTY	DESCRIPTION	MODEL	SPEC	REMARKS
1	LY0669001	1	LT PAPER FEED FRAME UNIT	HL-L8350CDWT		
1	LY0669001	1	LT PAPER FEED FRAME UNIT	HL-L9200CDWT		
1	LY0669001	1	LT PAPER FEED FRAME UNIT	HL-L9300CDWT		
2	LY7866001	1	LT PAPER TRAY UNIT	HL-L8350CDWT		
2	LY7866002	1	LT PAPER TRAY UNIT	HL-L9200CDWT		
2	LU6969001	1	LT PAPER TRAY UNIT	HL-L9300CDWT		
3	LY0686001	1	LT COVER LEFT	HL-L8350CDWT		
3	LY0686001	1	LT COVER LEFT	HL-L9200CDWT		
3	LU6974001	1	LT COVER LEFT	HL-L9300CDWT		
4	LY0687001	1	LT COVER RIGHT	HL-L8350CDWT		
4	LY0687001	1	LT COVER RIGHT	HL-L9200CDWT		
4	LU6975001	1	LT COVER RIGHT	HL-L9300CDWT		
5	LY0688001	1	LT COVER REAR	HL-L8350CDWT		
5	LY0688001	1	LT COVER REAR	HL-L9200CDWT		
5	LY0688001	1	LT COVER REAR	HL-L9300CDWT		
6	LV1345001	1	LT RELAY PCB ASSY	HL-L8350CDWT		
6	LV1345001	1	LT RELAY PCB ASSY	HL-L9200CDWT		
6	LV1345001	1	LT RELAY PCB ASSY	HL-L9300CDWT		
7	LY0667001	1	LT EDGE ACTUATOR	HL-L8350CDWT		
7	LY0667001	1	LT EDGE ACTUATOR	HL-L9200CDWT		
7	LY0667001	1	LT EDGE ACTUATOR	HL-L9300CDWT		